



Mr.control™ ~since 1991

**HIGH
PERFORMANCE
FOR EVERYONE**

2026



OUTDOOR GEAR



THRU AXLE



SEAT CLAMP



COMPUTER MOUNT



CHAIN GUIDE

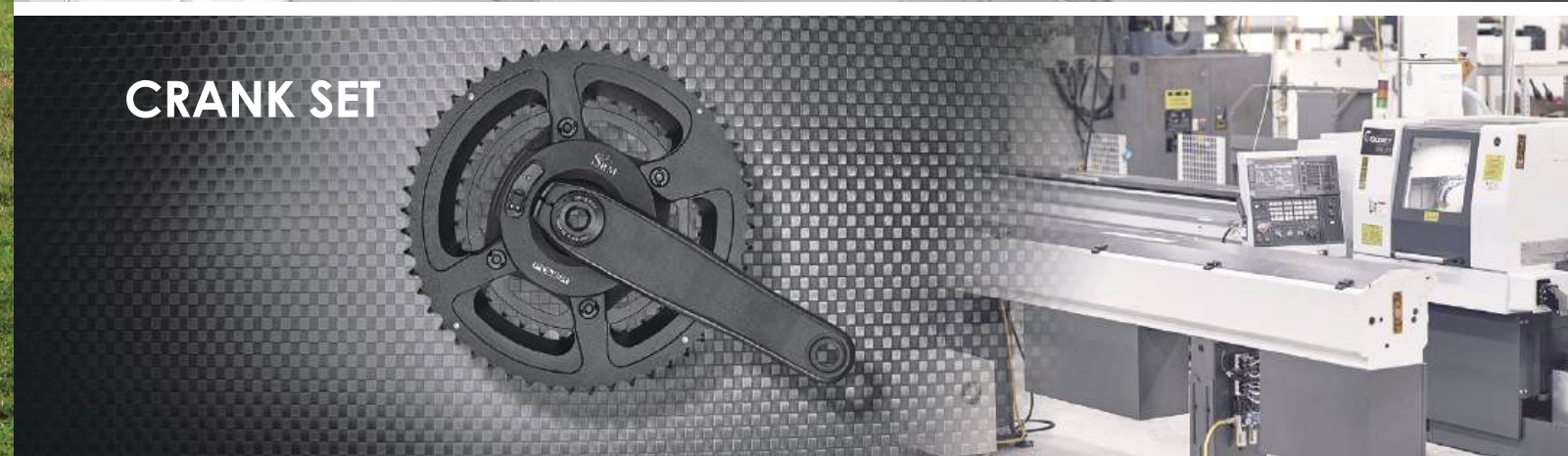

CRANK SET

TECHLONOGY	05
THRU AXLE	06
QUICK RELEASE	12
SEAT CLAMP	16
TOP CAP	26
HEADSETS PARTS	28
CRANK SET	32
CHAINRING SYSTEM	34
E-BIKE SYSTEM	38
ROLLER KIT SERIES	40
BMX SERIES	42
CHAINRING PARTS	44
CHAIN GUIDE SYSTEM	46
BRAKE SYSTEM	54
SEATPOST	58
STEM SYSTEM	60
HANDLEBAR	63
AEROBAR SYSTEM	66
COMPUTER MOUNT	68
CAGE	78
ACCESSORIES	80
FITTING EQUIPMENT	100
PEDALS	102
OUTDOOR GEAR	106

TECHNOLOGY

CARBON INJECTION TECHNOLOGY

We started to use carbon Long fibers with nylon Injection to Create carbon high texture lightweight products. Long fibers in the pellet form Advantage.

FATIGUE TESTING MACHINE

To ensure the safety of riders, we thoroughly test every product according to the "CEN" standards. It's our goal to let our riders not only experience lightweight but also safety.

INSPECTION MACHINE

Our lightweight carbon-fiber made products are of the finest quality. To assure this quality, we test our carbon-fiber products from top to bottom with the inspection machine.

MICROCOMPUTER ATTENUATION TESTER

We our pioneers in product quality and know that carbon-fiber is an ambiguous material. Therefore we also check our carbon-fiber made products' strength by our Microcomputer Attenuation Test. The test puts them under 150kg of pure force, two times, for 30 seconds. The result, a safe and reliable product that every rider can trust.our carbon-fiber products from top to bottom with the inspection machine.

HARDNESS TESTING MACHINE

To assure the intensity and safe structure of our products to meet the international standards, we carry out discreet sample inspection to pass the hardness test. It is important to us that we deliver consistency in our product quality.

COORDINATE MEASURING MACHINE

The coordinate measuring machine is key to reach our goal of high product standards. We only want to provide our customers the best and most excellent quality. Therefore we use 2.5D CMM techniques to test all our products.

EFBE, TESTING CENTER IN GERMANY

After EN testing at Cycling & Health Industry R&D Center (in Taiwan) we send our products for further inspections to EFBE in Germany, so that we can assure our high expectations and meet the international standard.



THRU AXLE

QUICK RELEASE

SEAT CLAMP

TOP CAP

HEADSETS PARTS

CRANK SET

CHAINRING SYSTEM

E-BIKE SYSTEM

ROLLER KIT SERIES

BMX SERIES

CHAINRING PARTS

CHAIN GUIDE SYSTEM

BRAKE SYSTEM

SEATPOST

STEM SYSTEM

HANDLEBAR

AEROBAR SYSTEM

COMPUTER MOUNT

CAGE

ACCESSORIES

FITTING EQUIPMENT

PEDALS

OUTDOOR GEAR

THRU AXLE

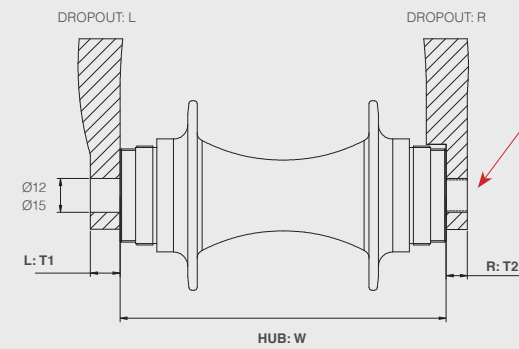

THREAD	
M12 x 1.0	SRAM*
M12 x 1.5	SHIMANO*
M12 x 1.75	SRAM*
M15 x 1.5	SHIMANO*

Custom Axle Spec

Standard 100mm Front
Boost 110mm Front
Standard 135/142mm Rear
Boost 148mm Rear
DH150 Rear
Super Boost 157mm Rear

SPEC	Diameter: T1	HUB: W	Diameter: T2	Thread Nut
FORK	-	-	-	W/I
FRAME	-	-	-	W/I

NEW

SPAX-UA-1-142 (168mm)
SPAX-UA-1-148 (176mm)

BEST SELLER

7-01

Thru axle with UDH hanger set.

MATERIAL: Axle / High Strength AL6066-T6
Hanger / High Strength AL6066-T6 / Nylon12+Glass Fiber
Custom length thread design available.

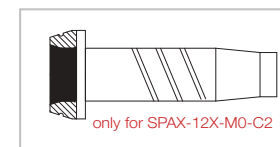

P.A.T. ED World Wide

SPAX-12X-M0-C2

BEST SELLER

7-02

MATERIAL: AL6066-T6
SPEC: Refer to the specification table.
OPTION: Thread M12 x 1.0 // M14 x 1.5 / M15 x 1.5
Custom length thread design available



12mm axle with CNC cut to save weight and spiro helicoïd cut to prevent axle stuck with dust and mud and prevent the axle stuck in the hub.



Allen key design at front head and rear end to make a longer life use.

Customized colors available.



SPAX-M16-12X-C2

BEST SELLER

7-03

MATERIAL: AL6066-T6
SPEC: Refer to the specification table.
OPTION: Thread M12 x 1.0 // M12 x 1.5 / M12 x 1.75
Custom length thread design available



SPAX-121-C2 / SPAX-66-C2

7-04

MATERIAL: AL7075-T6 / AL6066-T6
SPEC: Refer to the specification table.
OPTION: Thread M12 x 1.0 // M14 x 1.5 / M15 x 1.5
Custom length thread design available
12mm / 15mm axle custom design available

THRU AXLE

(OPTION: C2)

AXLE TYPE OPTION: C2 type / With light weight / CNC cut design



Custom length thread design available / Refer to the specification table

	Hub	Axle Length	Thread Pitch
MTB	135 SHIMANO*	168	M12 x 1.75 W/I nut
MTB	142 SHIMANO*	171	M12 x 1.5 W/I nut
MTB	148 SHIMANO*	177	M12 x 1.5 W/I nut
MTB	150 SHIMANO*	183	M12 x 1.75 W/I nut

	Hub	Axle Length	Thread Pitch
ROAD	100 SHIMANO*	118	M12 x 1.5 W/O nut
ROAD	142 SHIMANO*	160	M12 x 1.5 W/O nut
MTB	135 SRAM*	167	M12 x 1.75 W/O nut
MTB	142 SRAM*	174	M12 x 1.75 W/O nut
MTB	148 SRAM*	180	M12 x 1.75 W/O nut
MTB	150 SRAM*	182	M12 x 1.75 W/O nut
ROAD	100 SRAM*	125	M15 x 1.5 W/O nut



P.A.T. ED



SPAX-TL-12X

BEST SELLER

8-01

Integrated 6mm allen key system with 12mm / 15mm hollow axle, with cover to keep tool in position.

MATERIAL: AL6066-T6 axle
SPEC: Refer to the specification table.
OPTION: Thread M12 x 1.0 / M14 x 1.5 / M15 x 1.5
Custom length thread design available
12mm / 15mm axle custom design available



QR-TAK-12X/15X-C2

8-02

Step-in System Lever removable. With 4mm allen key for stem bolt / clamp bolt.

MATERIAL OF LEVER: Carbon Injection
MATERIAL OF AXLE: AL6066-T6
SPEC: Refer to the specification table.
OPTION: Thread M12 x 1.0 / M14 x 1.5 / M15 x 1.5
Custom length thread design available



QR-MF18-12X (C2)

8-03

Light weight design lever / lever can be adjusted from rotational position.

MATERIAL OF LEVER: Carbon Injection
MATERIAL OF AXLE: AL6066-T6
SPEC: Refer to the specification table.
OPTION: Thread M12 x 1.0 / M12 x 1.75 with nut C2 Axle
Custom length design available
12mm axle for front fork available



NEW AXLE-CUT-V

9-01

Tool for Axle length cutting.

MATERIAL: Crmo-steel
SPEC: 12mm Axle only



QR-SPAX-12X (C2)

9-02

For 135mm / 142mm / 148mm / 150mm hub.

MATERIAL: AL7075 axle / Alloy lever
SPEC: Refer to the specification table
OPTION: Thread M12 x 1.0 / M12 x 1.75 with nut
C2 Axle type available
Custom length design available
12mm axle for front fork available



QR-SPOL-12X (C2)

9-03

For 135mm / 142mm / 148mm / 150mm hub.

MATERIAL: AL7075 axle
Alloy and carbon bonded lever
SPEC: Refer to the specification table.
OPTION: Thread M12 x 1.0 / M12 x 1.75 with nut
C2 Axle type available
Custom length design available
12mm axle for front fork available



QR-MF5-12X/15X (C2)

9-04

Lever can be adjusted from rotational position. Max force to 150kg.

MATERIAL: AL6066 axle / AL6061 lever
SPEC: Refer to the specification table.
OPTION: Thread M12 x 1.0 / M14 x 1.5 / M15 x 1.5
OPTION: Thread M12 x 1.0 / M12 x 1.75 with nut
C2 Axle type available
Custom length design available
12mm axle for front fork available



SPAX-12X-R2R

9-05

Protects the dropout from side impacts, strengthens interface between derailleur and frame, with custom length thru axle.

MATERIAL: AL6061-T6
COLOR: Sand blast black
SPEC: Custom length thread design available
Axle length 160.8mm pitch M12*1.5 fit 2023 Giant TCR & PROPEL & DEFY.



NEW UDH-R2R

9-06

For UDH hanger system, protects the dropout from side impacts, strengthen interface between derailleur and frame.

HANGER MATERIAL: High strength AL 6066-T6
Nylon12+Glass Fiber
PROTECTOR MATERIAL: AL 6061T6
COLOR: black
WEIGHT: 66g



UDH-R2R

THRU AXLE



- Adapter for 9mm fork
- Adapter for Ø12mm, width 100mm fork
- Adapter for Ø15mm, width 100mm fork
- Adapter for Ø15mm, width 110mm fork



BIKE HOLDER-18 10-01

Bike fork mount rack carrier. For normal quick release. Ø12mm width 100mm Ø15mm width 100mm Ø15mm width 110mm



QR-SMW-EX 10-02

Chain washer for thru-axle Ø12mm frame. With 3 size screw adapter easy to adjustment.

MATERIAL: AL6066-T6
Carbon composite / Plastic / AL7075 screw adapter
WEIGHT: 88g/set (With adapter)



QR-SMS 10-03

Chain hanger. WEIGHT: 46g/set



QR-SM-PLW 10-04

Chain washer for thru-axle Ø12mm frame.

MATERIAL: Plastic
WEIGHT: 92g/set (142mm)
SPEC: Width 142 / 148 / 150mm

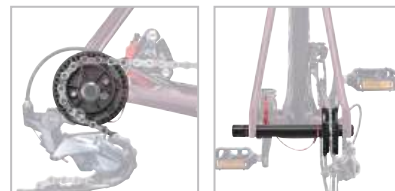

QR-SM-DISC PAD 10-05

Disc pad. For disc caliper.



BEST SELLER QR-SM-PLR-142E 148E / 150E 11-01

Handy chain tension device for travelling. For rear Ø12mm thru axle frame.

MATERIAL: Nylon
SPEC : Width 142 / 148 / 150mm
WEIGHT: 46g/pcs (142E)

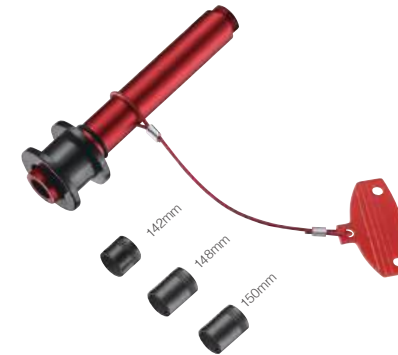

QR-SM-TAR 11-02

For rear Ø12mm thru axle. Include width adjuster: 142, 148, 150mm.

MATERIAL: AL6061-T6
WEIGHT: 91g/set (with adapter)



QR-SM-TAF012 / TAF015 TAF0151 / TAF020 11-03

For fork Ø12 x 100 thru axle
Ø15 x 100 thru axle
Ø15 x 110 thru axle
Ø20 x 110 thru axle

MATERIAL: AL6061-T6
WEIGHT: 33g/pcs (TAF015)
44g/pcs (TAF020)



135mm/130mm Adapter



Chain Washer

QR-SMW/R (RC) 11-04

Chain washer. With 135mm / 130mm adapter.

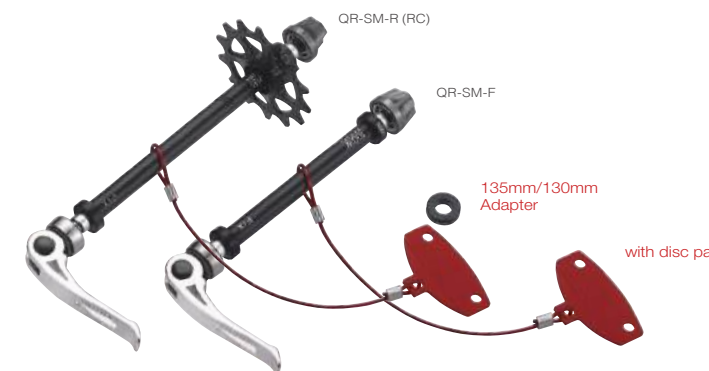

QR-SM-R (RC)

QR-SM-F

135mm/130mm Adapter

with disc pad

QR-SM 11-05

QR-SM-F / 100 with disc pad
QR-SM-R / 135 with roller and disc pad
QR-SM-RC / 130 with roller and disc pad

QUICK RELEASE

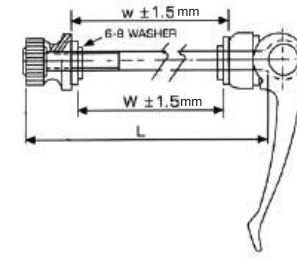
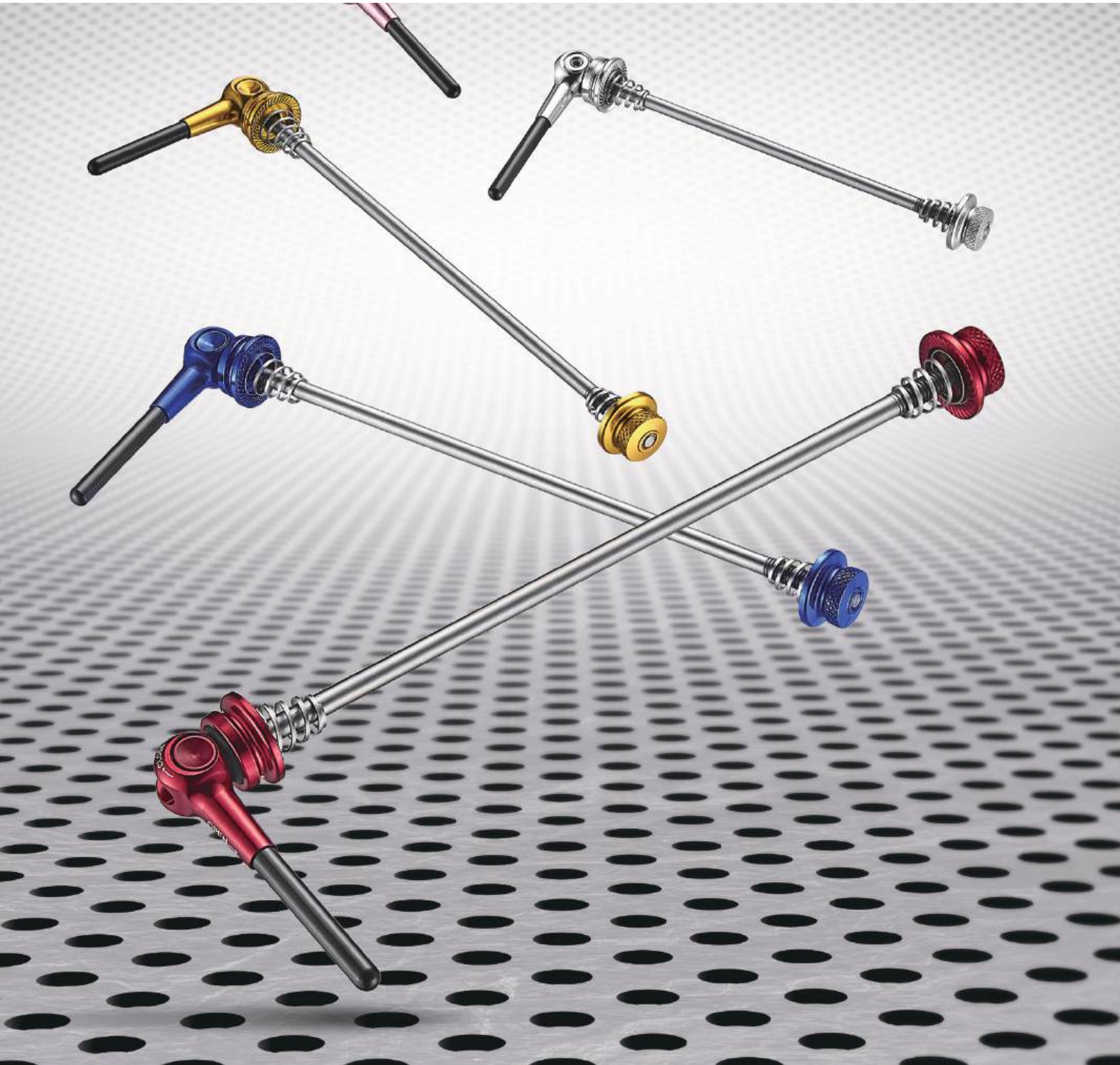

CHART (inmm)

L	PARTS	W	Dia
51	P5+2T	27	8
51	P7+2T	25	8
51	P5	30	6
56	P7+2T	30	8
51	P7	28	6
56	P7+00	33	6
56	P5+00	35	6
136	HUB W:100 / Dropout / t: 4 x 2	108	5
139	HUB W:100 / Dropout / t: 5.5 x 2	111	5
178	HUB W:135 / Dropout / t: 7 x 2	149	5
180	135 / t: 8 x 2	151	5

Double threaded screw PS. 2T= Ø6mm Ø8mm → L-3mm

L	PARTS	W	Dia
68	P5	35	6
68	P7	33	6
60	P5	28	6
Hub QR	L-39	W	5
150/F	Hub w:100 / t: 5.5 x 2	111	5
153/F	Hub w:100 / t: 7 x 2	114	5
181/RC	Hub w:130 / t: 7 x 2	144	5
188/R	Hub w:135 / t: 7 x 2	149	5
192/R	Hub w:135 / t: 9 x 2	153	5

QR-SPOC-F/R (RC) 13-01

Ti axle or Cr-Mo axle / Alloy lever.

WEIGHT: 45g/pair (ROAD) / 47g/pair (MTB)

OPTION: Hollow bolt axle available

QR-SPOC-F / 100 for front

QR-SPOC-R / 135 for MTB rear

QR-SPOC-RC / 130 for Road bike rear

QR-SPL-F/R (RC) 13-02

Cr-Mo axle / Alloy lever.

WEIGHT: 71g/pair (ROAD) / 75g/pair (MTB)

OPTION: Ti axle

QR-SPL-F / 100 for front

QR-SPL-R / 135 for MTB rear

QR-SPL-RC / 130 for Road bike rear

QR-20E-F/R (RC) 13-03

Steel axle / Alloy lever.

WEIGHT: 113g/pair (ROAD)

QR-KM2H-M52 13-04

Cr-Mo axle.

QR-KM2H-M52F / 100 for front

QR-KM2H-M52R / 135 for MTB rear

QR-KM2H-M52RC / 130 for Road bike rear

QR-KE06H-M54 13-05

New style for economy quick release. AL6061-T6 / Cr-Mo axle.

WEIGHT: 115g/pair (ROAD) / 118g/pair (MTB)

QR-KE06H-M54S / for seattube

QR-KE06H-M54F / 100 for front

QR-KE06H-M54R / 135 for MTB rear

QR-KE06H-M54RC / 130 for Road bike rear

QR-KE06E BEST SELLER 13-06

New style for economy quick release. AL6061-T6 / Steel axle.

WEIGHT: 121g/pair (ROAD) / 124g/pair (MTB)

QR-KE06E-SE / for seattube

QR-KE06E-EF / 100 for front

QR-KE06E-ER / 135 for MTB rear

QR-KE06E-ERC / 130 for Road bike rear

QR-SPOT-F/R (RC) 12-01

Ti axle or Cr-Mo axle. Alloy and Carbon bonded lever.

WEIGHT: 43g/pair (ROAD) / 46g/pair (MTB)

OPTION: Hollow bolt axle available

QR-K-F/R (RC) 12-02

Ti axle / Alloy lever.

WEIGHT: 53g/pair (ROAD) / 56g/pair (MTB)

OPTION: Cr-Mo axle



THRU AXLE

QUICK RELEASE

SEAT CLAMP

TOP CAP

HEADSETS PARTS

CRANK SET

CHAINRING SYSTEM

E-BIKE SYSTEM

ROLLER KIT SERIES

BMX SERIES

CHAINRING PARTS

CHAIN GUIDE SYSTEM

BRAKE SYSTEM

SEATPOST

STEM SYSTEM

HANDLEBAR

AEROBAR SYSTEM

COMPUTER MOUNT

CAGE

ACCESSORIES

FITTING EQUIPMENT

PEDALS

OUTDOOR GEAR

QUICK RELEASE

QR-KM2 14-01

QR-KM2-SE for seattube
QR-KM2-EF / 100 for front
QR-KM2-ER / 135 for MTB rear
QR-KM2-ERC / 130 for Road bike rear

QR-KM1 14-02

QR-KM1-SE for seattube
QR-KM1-EF / 100 for front
QR-KM1-ER / 135 for MTB rear
QR-KM1-ERC / 130 for Road bike rear

QR-11-E BEST SELLER 14-03

With plastic nut + steel.

QR-11-SE for seattube
QR-11-EF / 100 for front
QR-11-ER / 135 for MTB rear
QR-11-ERC / 130 for Road bike rear

QR-11-H 14-04

With alloy nut.

QR-11-SH for seattube
QR-11-HF / 100 for front
QR-11-HR / 135 for MTB rear
QR-11-HRC / 130 for Road bike rear

QR-E21 BEST SELLER 14-05

With plastic nut + steel.

QR-E21-SE for seattube
QR-E21-F / 100 for front
QR-E21-R / 135 for MTB rear
QR-E21-RC / 130 for Road bike rear

QR-KM2-SE 14-06

For seattube.
Cr-Mo axle.
AL6061-T6 lever.

QR-CLOSE 14-07

For seattube.
Cr-Mo axle.
AL6061-T6 lever.

QR-XL 14-08

For seattube.
Cr-Mo axle.
AL6061-T6 lever.

QR-OPEN-SE 14-09

For seattube.
Cr-Mo axle.
AL6061-T6 lever.

QR-112H2 14-10

For seattube.
Cr-Mo axle.
AL6061-T6 lever.

QR-72E BEST SELLER 15-01

Cr-Mo axle / Alloy lever.

WEIGHT: 125g/pair (ROAD)
126.5g/pair (MTB) / 41.5g/pcs (S)

QR-72E-S / for seattube
QR-72E-F / 100 for front
QR-72E-R / 135 for MTB rear
QR-72E-RC / 130 for Road bike rear

QR-72M 15-02

Cr-Mo axle / With longer lever (72mm).

WEIGHT: 100g/pair (ROAD)
103g/pair (MTB) / 39g/pcs (S)

QR-72M-S for seattube
QR-72M-F / 100 for front
QR-72M-R / 135 for MTB rear
QR-72M-RC / 130 for Road bike rear

QR-72H 15-03

Cr-Mo axle / With longer lever (72mm).

WEIGHT: 123g/pair (ROAD)
125g/pair (MTB) / 44g/pcs (S)

QR-72H-S for seattube
QR-72H-F / 100 for front
QR-72H-R / 135 for MTB rear
QR-72H-RC / 130 for Road bike rear

normal 60mm

72mm
normal 60mm

72mm
normal 60mm

SP-56 15-04

With special allen key to lock & release.

SP-56-F / 100 for front
SP-56-R / 135 for MTB rear
SP-56-RC / 130 for Road bike rear
TOOL OPTION: Key ring

5mm
Beer Opener (P.A.T ED)
Tool option

Pin type

SP-56H 15-05

With special allen key to lock & release.
Hollow bolt (for F & R axle) & Carbon reinforce.

SP-56-SH for seattube
SP-56-HF / 100 for front
SP-56-HR / 135 for MTB rear
SP-56-HRC / 130 for Road bike rear

Pin type

SP-66 15-06

For seattube.
Cr-Mo axle.

MATERIAL: AL6061-T6

BOLT	W	BOLT	W
40	24	55	39
45	29	60	44
50	34		

CL-AH2-001 CL-AH2-002

CL-AH2 15-07

For seattube.

MATERIAL: Steel heat treatment CNC finished
W: 19mm / 22mm / 25mm / 27mm
CL-AH2-001 with anti-pin
CL-AH2-002 with knurl

W

CL-AH 15-08

For seattube.

MATERIAL: Steel heat treatment
W: 19mm / 22mm / 25mm / 27mm

Our quick release levers come with various lengths. Besides the regular length (65mm), we also provide the following length for your reference: 65mm, 72mm and 90mm.

90mm QR-XL...
72mm QR-72...
65mm QR-11...

SEAT CLAMP



P.A.T.ED WORLD WIDE

OVER SIZE BEST SELLER CL-CV

17-01

Extend rubber cover, to prevent dust permeate in to seattube. Chamfer edge & oval hole design to protect carbon frame & seatpost.

MATERIAL: AL6061-T6 clamp with NBR cover
SPEC: Ø27.2 seatpost - Ø31.8 seattube / Ø31.6 seatpost - Ø34.9 seattube
 Ø27.2 seatpost - Ø34.9 seattube / Ø30.9 seatpost - Ø34.9 seattube
 Ø33.9 seatpost - Ø38.1 seattube / Ø34.9 seatpost - Ø38.6 seattube
H: 16mm (12mm insert)
COLOR: Clamp: Black anodize
 Cover: Black, Red, Blue, Apple Green, Orange, Pink, White, Yellow

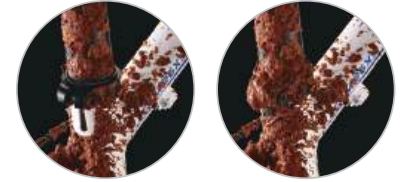

OVER SIZE BEST SELLER CL-FJ21

17-02

MATERIAL: AL6066 CNC made
SPEC: Ø28.6, Ø31.8, Ø34.9, Ø38.6
H: 14mm
COLOR: As Order
STANDARD: Blast anodize
OPTION: H 16.5mm
 Oval hole design for carbon fiber



OVER SIZE CL-FJ21-2

17-03

MATERIAL: AL6066 CNC made
SPEC: Ø28.6, Ø31.8, Ø34.9, Ø38.6
H: 14mm
COLOR: As Order
STANDARD: Blast anodize
OPTION: H 16.5mm
 Oval hole design for carbon fiber



OVER SIZE BEST SELLER CL-FJ21-1

17-04

MATERIAL: AL6066 CNC made
SPEC: Ø28.6, Ø31.8, Ø34.9, Ø38.6
H: 14mm
COLOR: As Order
STANDARD: Blast anodize
OPTION: H 16.5mm
 Oval hole design for carbon fiber



OVER SIZE CL-07-2X

17-05

MATERIAL: AL6061 CNC made
 Two M5 x 20mm bolt
SPEC: Ø28.6, Ø31.8, Ø34.9, Ø38.1, Ø38.6
H: 20mm
COLOR: As Order
 Special chamfer for carbon frame



CL-07GB-CO

17-06

Seat clamp with cover.
MATERIAL: AL6061 CNC made
SPEC: Ø27.2 seatpost - Ø31.8 seattube
 Ø31.6 seatpost - Ø34.9 seattube
H: 17.5mm (13mm insert)
COLOR: As Order / Black cover
 Oval hole design for carbon fiber



CL-07FB2-CO (-CI)

17-07

Seat clamp with cover.
MATERIAL: AL6061 CNC made
SPEC: Ø27.2 seatpost - Ø31.8 seattube
 Ø31.6 seatpost - Ø34.9 seattube
H: 18.5mm (14mm insert)
COLOR: As Order / Black cover
OPTION: CL-07FB2-CO (-CI)
 (Carbon shim inside)
 Oval hole design for carbon fiber
 Special chamfer for carbon frame



NEW CL-CR25

17-08

MATERIAL: AL6061 T6 Forged made
SPEC: Ø31.8, Ø 34.9
H: 14.6MM
COLOR: As Order
STANDARD: Sand Blast anodize



CL-07JB1-CO

17-09

Seat clamp with cover.
MATERIAL: AL6061 CNC made
SPEC: Ø27.2 seatpost - Ø31.8 seattube
 Ø31.6 seatpost - Ø34.9 seattube
H: 17mm (13mm insert)
COLOR: As Order / Black cover
 Oval hole design for carbon fiber
 Special chamfer for carbon frame

SEAT CLAMP



OVER SIZE
CL-07 **BEST SELLER** 18-01

MATERIAL: AL6061 CNC made
SPEC: Ø25.4, Ø28.6, Ø31.8, Ø34.9, Ø38.1, Ø38.6
H: 15mm
COLOR: As Order
WEIGHT: 22.5g



OVER SIZE **BEST SELLER**
CL-07-P / CL-07-P-2 18-02

MATERIAL: AL6061 CNC made
SPEC: Ø25.4, Ø28.6, Ø31.8, Ø34.9, Ø38.1, Ø38.6
H: 15mm
COLOR: As Order
WEIGHT: 22.5g
OPTION: Oval hole for carbon
CL-07-P-2: Two tone
Special chamfer for carbon frame



CL-02K 19-01

MATERIAL: AL6061
SPEC: Ø25.4, Ø28.6, Ø31.8, Ø34.9
H: 11mm
COLOR: As Order



Ø25.4 model



CL-02P / CL-02P-2 19-02

MATERIAL: AL6061
SPEC: Ø25.4, Ø28.6, Ø31.8, Ø34.9
H: 11mm
COLOR: As Order
CL-02P-2: Two tone



OVER SIZE
CL-07GE 18-03

With adjustable seatpost cable guide.
MATERIAL: AL6061 CNC made
SPEC: Ø31.8, Ø34.9, Ø38.1, Ø38.6
H: 15.5mm
COLOR: As Order



Oval hole design for carbon fiber



Special Chamfer for Carbon frame



OVER SIZE
CL-03GB 19-03

MATERIAL: AL6061
SPEC: Ø25.4, Ø28.6, Ø31.8, Ø34.9, Ø37, Ø38.1
H: 15mm
COLOR: As Order



CL-02GB 19-04

MATERIAL: AL6061
SPEC: Ø25.4, Ø28.6, Ø31.8, Ø34.9
H: 11mm
COLOR: As Order



OVER SIZE
CL-07GE-CI 18-04

With adjustable seatpost cable guide. Carbon shim inside.
MATERIAL: AL6061 CNC made
SPEC: Ø31.8, Ø34.9, Ø38.1, Ø38.6
H: 15.5mm
COLOR: As Order



CL-AD 18-05

MATERIAL: AL6061 CNC made
SPEC: Ø31.8, Ø34.9
Double bolts
H: 24mm
COLOR: As Order
Oval hole design for carbon fiber



CL-02JB 19-05

MATERIAL: AL6061
SPEC: Ø25.4, Ø28.6, Ø31.8, Ø34.9
H: 11mm
COLOR: As Order



CL-05-15D 19-06

MATERIAL: AL6061 CNC made
SPEC: Dia As Order
H: 15mm
COLOR: As Order
OPTION: Oval hole for carbon
Special chamfer for carbon frame



CL-AD-A1 18-06

MATERIAL: AL6061 CNC made
SPEC: Ø28.6, Ø31.8, Ø34.9
H: 15mm
COLOR: As Order
STANDARD: Blast anodize



OVER SIZE
CL-H2C 18-07

MATERIAL: AL6066 CNC made
SPEC: Ø31.8, Ø34.9, Ø36, Ø37, Ø38.1
H: 14mm
COLOR: As Order
STANDARD: Blast anodize
OPTION: Ø28.6, Ø29.8, Ø30.0, Ø40.0 (price different)
Oval hole design for carbon fiber



CL-033K 19-07

MATERIAL: AL6061
SPEC: Ø25.4, Ø28.6, Ø31.8, Ø34.9
H: 15mm
COLOR: Blast anodize



CL-J5B 19-08

MATERIAL: AL6061
SPEC: Ø25.4, Ø28.6, Ø31.8, Ø34.9
H: 13.5mm
COLOR: As Order



CL-55GB 18-08

MATERIAL: AL6061
SPEC: Ø31.8, Ø34.9
H: 10.5mm
COLOR: As Order
STANDARD: Blast anodize



OVER SIZE
CL-H2C-2 18-09

MATERIAL: AL6066 CNC made
SPEC: Ø31.8, Ø34.9, Ø36, Ø37, Ø38.1
H: 14mm
COLOR: As Order
STANDARD: Blast anodize
OPTION: Ø28.6, Ø29.8, Ø30.0, Ø40.0 (price different)
Oval hole design for carbon fiber



CL-94B 19-09

MATERIAL: AL6061
SPEC: Ø25.4, Ø28.6, Ø31.8, Ø34.9
H: 11mm
COLOR: As Order



CL-STEM 19-10

MATERIAL: AL6061
SPEC: Ø28.6
H: 10mm
COLOR: Blast black anodize



SEAT CLAMP



CL-FDG3 20-01

For front derailleur, brazed on style clamp.
Additional stopper for front derailleur screw.

MATERIAL: AL6061
SPEC: Ø28.6, Ø31.8, Ø34.9mm
COLOR: As Order



Additional stopper



Big shape for frame Ø34.9



CL-EFD-33 20-02

For E-Bike front derailleur.
Brazed on style clamp.
Additional stopper for front derailleur screw.

MATERIAL: AL6061
SPEC: Ø31.8, Ø34.9mm
COLOR: As Order
WEIGHT: 30g



CL-FDG2-9 20-03

For front derailleur.

MATERIAL: AL6061
SPEC: Ø31.8, Ø34.9
9°+ 20mm offset
COLOR: As Order

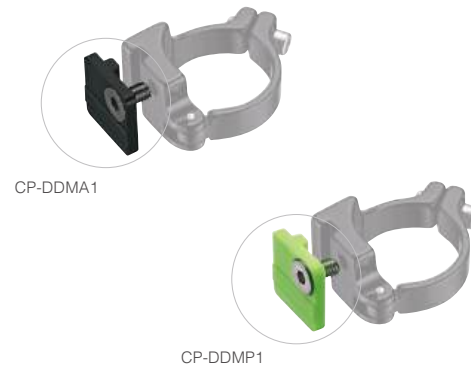

CP-DDMA1

CP-DDMP1

CP-DDMA1 21-01

Direct mount (D Type) front derailleur cap with AL7075 M6 bolt.

MATERIAL: AL6061-T6
COLOR: As Order

CP-DDMP1 21-02

Direct mount (D Type) front derailleur cap with stainless steel M6 bolt.

MATERIAL: Nylon
COLOR: As Order



CL-STOPPER-CO / CL-STOPPER 21-03

To prevent the drop caused by the tolerance between seatpost & clamp & seattube. Also can be height marker with rubber cover to prevent dust can fix any type of clamp.

MATERIAL: AL6061-T6 clamp / Rubber cover
SPEC: Ø27.2, Ø30.9, Ø31.6

COLOR: Clamp: Blast black anodize
Cover: Black, Red, Blue, Apple Green, Orange, Pink, White, Yellow



CL-FD 20-04

For front derailleur.

MATERIAL: AL6061
SPEC: Ø28.6, Ø31.8, Ø34.9
COLOR: As Order



CL-FDM 20-05

Cold forged, for front derailleur.

MATERIAL: AL6061
SPEC: Ø31.8, Ø34.9
COLOR: As Order



CL-A1K 21-04

MATERIAL: AL6061
SPEC: Ø31.8, Ø34.9
H: 14mm
COLOR: As Order



CL-51 21-05

Clamp with cable stop.

MATERIAL: AL6061
SPEC: Ø31.8, Ø34.9
H: 12mm
COLOR: As Order



CL-CX 20-06

Canti brake cable hanger.

MATERIAL: AL6061
SPEC: Ø31.8, Ø34.9
H: 16mm
COLOR: As Order
STANDARD: Blast anodize



CL-50 20-07

Replaceable for SHIMANO® E-type front derailleur's seattube eyelet.

MATERIAL: AL6061
SPEC: Ø28.6, Ø31.8, Ø34.9
H: 10mm
COLOR: As Order



CL-A1 21-06

MATERIAL: AL6061
SPEC: Ø28.6, Ø31.8, Ø34.9
H: 14mm
COLOR: As Order



CL-95SUB-A14 21-07

MATERIAL: AL6061 CNC made
SPEC: Ø31.8, Ø34.9
H: 16mm
COLOR: As Order



CL-FR 20-08 BEST SELLER

MATERIAL: AL6061
SPEC: Ø28.6, Ø29.8, Ø31.8, Ø34.9
H: 13.5mm
COLOR: As Order
STANDARD: Blast anodize

M5 Thread for carrier



CL-5085V 20-09

For converting frames with top mounted cable to traditional bottom pull front derailleurs.

MATERIAL: AL6061
SPEC: Ø28.6, Ø31.8, Ø34.9
H: 10mm
COLOR: As Order



OVER SIZE CL-030 21-08

MATERIAL: AL6061
SPEC: Ø25.4, Ø28.6, Ø31.8, Ø34.9, Ø37, Ø38.1
H: 13.5mm
COLOR: As Order



OVER SIZE CL-95B 21-09

MATERIAL: AL6061
SPEC: Ø25.4, Ø28.6, Ø31.8, Ø34.9, Ø37, Ø38.1, Ø38.6
H: 13.5mm
COLOR: As Order



SEAT CLAMP



OVER SIZE
CL-951B 22-01
MATERIAL: AL6061
SPEC: Ø25.4, Ø28.6, Ø31.8, Ø34.9,
Ø37, Ø38.1, Ø38.6
H: 13.5mm
COLOR: As Order



OVER SIZE
CL-96B 22-02
MATERIAL: AL6061
SPEC: Ø28.6, Ø31.8, Ø34.9,
Ø37, Ø38.1
H: 13.5mm
COLOR: As Order



OVER SIZE
CL-97B 22-03
MATERIAL: AL6061
SPEC: Ø28.6, Ø31.8, Ø34.9,
Ø37, Ø38.1
H: 13.5mm
COLOR: As Order



CL-97GB 22-04
MATERIAL: AL6061
SPEC: Ø28.6, Ø31.8, Ø34.9
H: 15mm
COLOR: As Order



OVER SIZE
CL-93B-O 22-05
For BMX or Fixed gear.
MATERIAL: AL6061
SPEC: Ø25.4, Ø28.6, Ø31.8, Ø34.9,
Ø37, Ø38.1
H: 35mm
COLOR: As Order
Internal holes throughout



OVER SIZE
CL-93JB 22-06
MATERIAL: AL6061
SPEC: Ø25.4, Ø28.6, Ø31.8, Ø34.9,
Ø37, Ø38.1
H: 35mm
COLOR: As Order



OVER SIZE
CL-93JB-O 22-07
MATERIAL: AL6061
SPEC: Ø25.4, Ø28.6, Ø31.8, Ø34.9,
Ø37, Ø38.1
H: 35mm
COLOR: As Order
Internal holes throughout



OVER SIZE
CL-93B 22-08
MATERIAL: AL6061
SPEC: Ø25.4, Ø28.6, Ø31.8, Ø34.9,
Ø37, Ø38.1
H: 35mm
COLOR: As Order



CL-93JB-2-70L-O 22-09
For BMX or Fixed gear.
MATERIAL: AL6061
SPEC: Ø33.3, Ø34.9
H: 70mm
COLOR: As Order
Internal holes throughout



CL-73B 22-10
MATERIAL: AL6061
SPEC: Ø25.4, Ø28.6
H: 35mm
COLOR: As Order

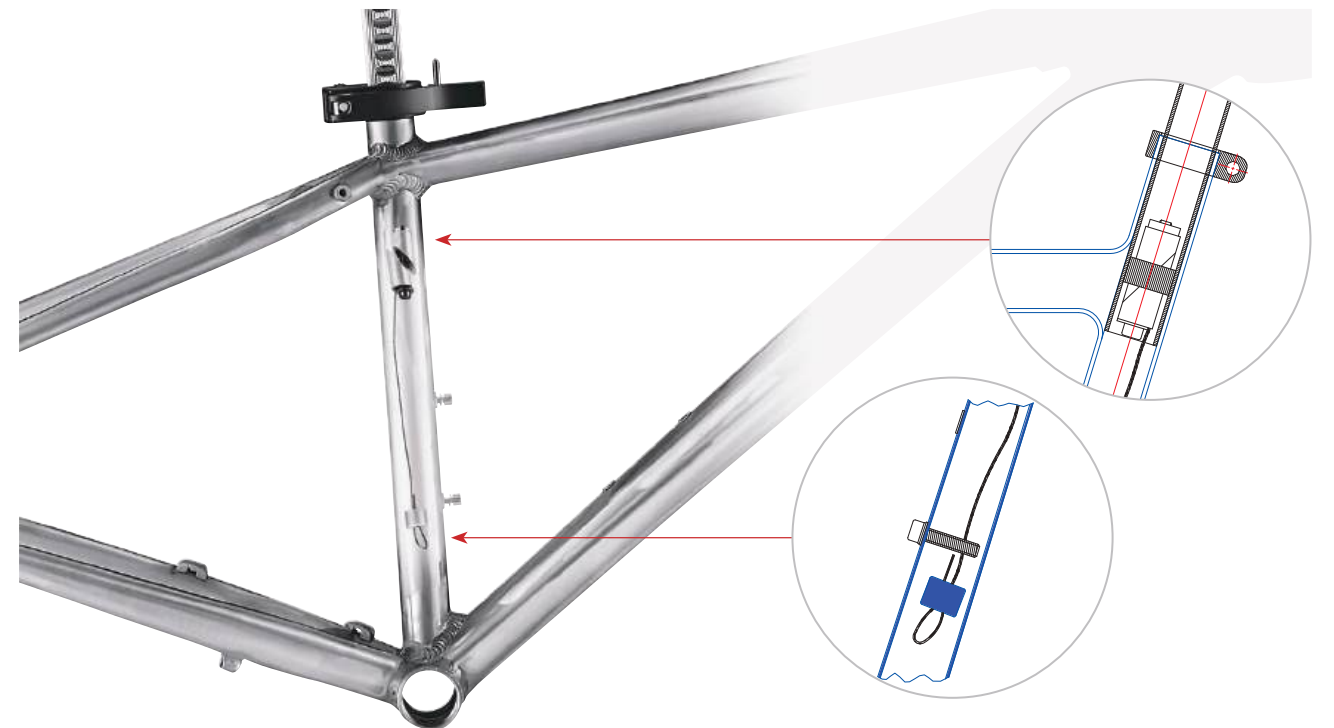

S/SAFE

23-01

Comes with one long bottle cage screw and two seatpost adapters.
MATERIAL: AL6061-T6

The easy-to-use S/SAFE pin secures your seatpost from stolen. Install the S/SAFE pin inside the seatpost. Then, screw tight the provided bottle cage screw. The long screw thus jams the passage of the S/SAFE pin, preventing the seatpost from pulled up.

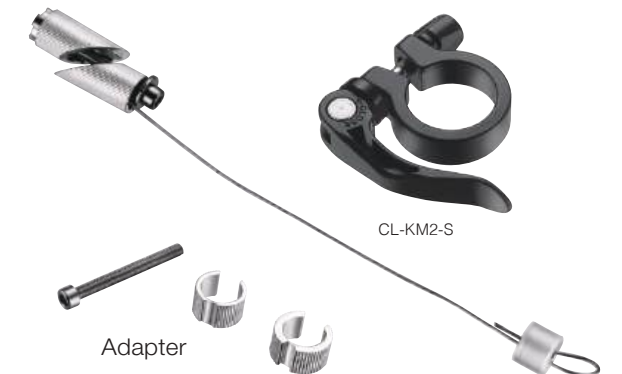

CL-KE06E-CV

23-02

Seat clamp with anti-dust cover.

MATERIAL: AL6061
SPEC: Ø27.2 seatpost - Ø31.8 seattube
Ø31.6 seatpost - Ø34.9 seattube
H: 20mm (15mm insert)
COLOR: As Order / Black cover
P.A.T ED



THRU AXLE

QUICK RELEASE

SEAT CLAMP

TOP CAP

HEADSETS PARTS

CRANK SET

CHAINRING SYSTEM

E-BIKE SYSTEM

ROLLER KIT SERIES

BMX SERIES

CHAINRING PARTS

CHAIN GUIDE SYSTEM

BRAKE SYSTEM

SEATPOST

STEM SYSTEM

HANDLEBAR

AEROBAR SYSTEM

COMPUTER MOUNT

CAGE

ACCESSORIES

FITTING EQUIPMENT

PEDALS

OUTDOOR GEAR

SEAT CLAMP



CL-KE06-QT 24-01

BEST SELLER

MATERIAL: AL6061
SPEC: Ø28.6, Ø31.8, Ø34.9
H: 13.5mm
COLOR: As Order





CL-KE06H-QT 24-02

MATERIAL: AL6061
SPEC: Ø28.6, Ø31.8, Ø34.9
H: 13.5mm
COLOR: As Order





CL-KM2-IT 24-03

MATERIAL: AL6061
SPEC: Ø28.6, Ø31.8, Ø34.9
H: 16mm
COLOR: As Order
STANDARD: Blast anodize

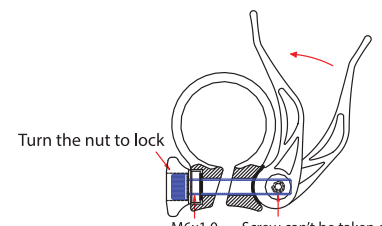

CL-KM2-IT-S 24-05

With special bolt and nut to lock.



Turn the nut to lock
M6x1.0 Screw can't be taken out

MATERIAL: AL6061
SPEC: Ø28.6, Ø31.8, Ø34.9
H: 16mm
COLOR: As Order
STANDARD: Blast anodize
P.A.T ED

CL-98XL 24-04

MATERIAL: AL6061
SPEC: Ø28.6, Ø31.8mm
H: 13.5mm
COLOR: As Order



CL-UBE76-S 24-06

OVER SIZE

New structure design clamp for rental bike, lever prevents rotation design.

MATERIAL: AL6061
SPEC: Ø31.8, Ø34.9, Ø38.1, Ø38.6, Ø40
Custom design available





CL-E21-QT 24-07

MATERIAL: AL6061
SPEC: Ø28.6, Ø31.8
H: 13.5mm
COLOR: As Order
P.A.T ED



CL-KM2 24-08

Cold forged.

SPEC: Ø25.4, Ø28.6, Ø31.8, Ø34.9
H: 13.5 mm
COLOR: As Order
STANDARD: Blast anodize





CL-KM2-S 24-09

With special bolt and nut to lock.



MATERIAL: AL6061
SPEC: Ø28.6, Ø31.8, Ø34.9
H: 13.5mm
COLOR: As Order
STANDARD: Blast anodize
P.A.T ED

CL-9872H-QT 25-01

OVER SIZE

MATERIAL: AL6061
With longer lever (72mm)
SPEC: Ø28.6, Ø31.8, Ø34.9, Ø38.6
H: 13mm
COLOR: As Order



CL-9872E-QT 25-02

OVER SIZE BEST SELLER

MATERIAL: AL6061
With longer lever (72mm)
SPEC: Ø28.6, Ø31.8, Ø34.9, Ø38.6, Ø40
H: 13mm
COLOR: As Order



CL-96QT 25-03

OVER SIZE BEST SELLER

MATERIAL: AL6061
SPEC: Ø25.4, Ø28.6, Ø31.8, Ø34.9, Ø37.0, Ø38.1, Ø38.6, Ø40
H: 13mm
COLOR: As Order



CL-98QT 25-04

BEST SELLER

MATERIAL: AL6061
SPEC: Ø25.4, Ø28.6, Ø31.8, Ø34.9
H: 13mm
COLOR: As Order



CL-9872M-QT 25-05

OVER SIZE

MATERIAL: AL6061
With longer lever (72mm)
SPEC: Ø28.6, Ø31.8, Ø34.9, Ø38.6
H: 13mm
COLOR: As Order

CL-KM1 25-06

SPEC: Ø25.4, Ø28.6, Ø31.8, Ø34.9
H: 13.5 mm
COLOR: As Order
STANDARD: Blast anodize



CL-KM1-J 25-07

SPEC: Ø25.4, Ø28.6, Ø31.8, Ø34.9
H: 13.5 mm
COLOR: As Order
STANDARD: Blast anodize



CL-KM1-J2 25-08

SPEC: Ø25.4, Ø28.6, Ø31.8, Ø34.9
H: 13.5 mm
COLOR: As Order
STANDARD: Blast anodize



Our quick release levers come with various lengths. Besides the regular length (65mm), we also provide the following length for your reference: 65mm, 72mm and 90mm.



THRU AXLE

QUICK RELEASE

SEAT CLAMP

TOP CAP

HEADSETS PARTS

CRANK SET

CHAINRING SYSTEM

E-BIKE SYSTEM

ROLLER KIT SERIES

BMX SERIES

CHAINRING PARTS

CHAIN GUIDE SYSTEM

BRAKE SYSTEM

SEATPOST

STEM SYSTEM

HANDLEBAR

AEROBAR SYSTEM

COMPUTER MOUNT

CAGE

ACCESSORIES

FITTING EQUIPMENT

PEDALS

OUTDOOR GEAR

TOP CAP



Screw weight information

M6x1.0x30L (5mm Allen key)	STEEL BOLT	STAINLESS BOLT	AL7075 BOLT
Weight	7.8g	7.8g	2.8g



TK-MG-CO 26-01

Top cap with full cover.

Material: AL6061-T6
 COLOR: As order
 WEIGHT: 9g
 Custom logo design available



TK-001S-Y01 TK-001S-Y02 TK-001S-Y03 26-02

MATERIAL: AL6061-T6 CNC made
 WEIGHT: 15g/pcs (W/O star nut)
 SIZE: 1-1/8"
 STANDARD: Blast anodize with star nut
 OPTION: AL7075-T73 screw
 Stainless screw



TK-001S-SPADE TK-001S-HEART TK-001S-DIAMOND TK-001S-CLUB 26-03

MATERIAL: AL6061-T6 CNC made
 WEIGHT: 15g/pcs (W/O star nut)
 SIZE: 1-1/8" with star nut
 OPTION: AL7075-T73 screw
 Stainless screw



TK-001S TK-001S-38.1 27-01

MATERIAL: AL6061-T6
 WEIGHT: 17.5g/pcs (W/O star nut)
 SIZE: 1", 1-1/8" or 1-1/2"
 OPTION: 1. Stainless screw
 2. Star nut



TK-BEERA 27-02

With TK-001S
 MATERIAL: AL6061-T6 CNC finished
 WEIGHT: 23g (W/O star nut)
 SIZE: 1-1/8"



TK-TD-C 27-03

MATERIAL: Carbon
 WEIGHT: 11.5g/pcs (W/O star nut)
 SIZE: 1-1/8"
 With star nut



TK-TD18 27-04

MATERIAL: AL6061-T6
 WEIGHT: 13.3g/pcs (W/O star nut)
 SIZE: 1-1/8"
 COLOR: Sand blast anodize with star nut
 OPTION: AL7075-T73 screw

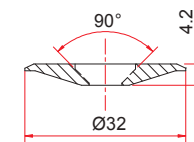

TK-TD12-E 27-05

MATERIAL: AL6061-T6
 WEIGHT: 16.5g/pcs (W/O star nut)
 SIZE: 1-1/8"
 COLOR: Sand blast anodize
 Stainless screw
 OPTION: AL7075-T73 screw

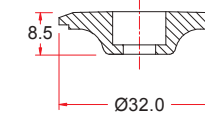

TK-TD01 27-06

MATERIAL: AL6061-T6
 WEIGHT: 13g/pcs (W/O star nut)
 SIZE: 1-1/8"
 COLOR: Sand blast anodize with star nut
 OPTION: AL7075-T73 screw
 Stainless screw

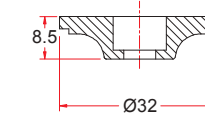

STAR NUT-29 27-07

For Ø31.8 Alloy / Cr-Mo fork.
 SPEC: Ø28.8
 WEIGHT: 10.5g/pcs



TK-001D 27-08

MATERIAL: AL6061-T6
 WEIGHT: 14.5g/pcs (W/O star nut)
 SIZE: 1", 1-1/8"
 OPTION: 1. Stainless screw
 2. Star nut



TK-SC-12AP 27-09

MATERIAL: AL6061-T6 cold forged made
 WEIGHT: 9.8g/pcs (W/O star nut)
 SIZE: 1-1/8"
 With star nut



TK-T032A 27-10

For Ø31.8 Fork.
 With stainless steel bolt.
 MATERIAL: AL6061-T6
 STANDARD: Blast anodize with star nut
 WEIGHT: 11.2g/pcs (W/O star nut)



TK-M3 27-11

MATERIAL: AL6061-T6
 WEIGHT: 32.5g/pcs (W/O star nut)
 SIZE: 1", 1-1/8"
 Stainless hollow M10 screw
 With star nut

HEADSETS PARTS

Reliable fork expander plugs make the fork design safer and better.

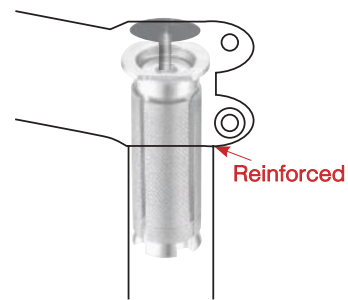

Suggestion With TK-001D



P.A.T ED
Reinforced
Carbon
Stem Tube

(Old No: TK012WS-CAL will update to this item)



TK-012SW **BEST SELLER** 28-01

For Ø28.6 Carbon fork, inner tube expander.

SPEC: Ø22.0 - Ø23.4 without shim
Ø23.4 - Ø25.0 with shim
H: 32mm, 50mm, 70mm
WEIGHT: 45g/set (50mm)



TK-032SW 28-02

For Ø31.8 Carbon fork, inner tube expander.
For OD2 carbon

SPEC: Ø27.5 - Ø27.7 with shim
H: 45mm
WEIGHT: 44g/set



TK-016SW 28-03

For Ø25.4 Carbon fork, inner tube expander.

SPEC: Ø19 - Ø21
Ø21 - Ø22 with T0.5 shim
Ø22 - Ø23 with T1.0 shim
H: 40mm
WEIGHT: 35g/set



EXT-2C 29-01

SPEC: Ø28.6 x Ø25.4
Ø25.4 x Ø22.2



ADP-STEM 29-02

Steering tube extend.
For Ø28.6 fork.

MATERIAL: AL6061-T6
LENGTH: 50mm, 90mm, 120mm
With top cap & long screw x2pcs for custom to assemble

Adjust the height (mm)

	MIN	MAX
50	47.5	65.5
90	47.5	105.5
120	47.5	135.5



TL-18 29-03

Star nut tooling.

SPEC: Ø25.4mm, Ø28.6mm



THRU AXLE

QUICK
RELEASE

SEAT CLAMP

TOP CAP

HEADSETS
PARTS

CRANK SET

CHAINRING
SYSTEM

E-BIKE SYSTEM

ROLLER KIT
SERIES

BMX SERIES

CHAINRING
PARTS

CHAIN GUIDE
SYSTEM

BRAKE SYSTEM

SEATPOST

STEM SYSTEM

HANDLEBAR

AEROBAR
SYSTEM

COMPUTER
MOUNT

CAGE

ACCESSORIES

FITTING
EQUIPMENT

PEDALS

OUTDOOR GEAR

HEADSETS PARTS



LIGHT WEIGHT
AE-28.6-H **BEST SELLER** 30-01
 Alloy spacer.
P.A.T ED
 SPEC: AE-28.6-H (ID $\varnothing 28.8 \pm 0.2$ x OD $\varnothing 34$)
 H: As Order
 COLOR: As Order



BEST SELLER
AR-25.4-H / AR-28.6-H
AR-31.8-H / AR-38.1-H 30-02
 Alloy spacer.
 SPEC: AR-25.4-H (ID $\varnothing 25.6 \pm 0.2$ x OD $\varnothing 32$)
 AR-28.6-H (ID $\varnothing 28.8 \pm 0.2$ x OD $\varnothing 32.5, \varnothing 33, \varnothing 34, \varnothing 35, \varnothing 36$)
 AR-31.8-H (ID $\varnothing 32.0 \pm 0.2$ x OD $\varnothing 38.8$)
 AR-38.1-H (ID $\varnothing 38.3 \pm 0.2$ x OD $\varnothing 44$)
 H: As Order
 COLOR: As Order



NEW
AR-28.6-H 31-01
 Alloy spacer for $\varnothing 28.6$ fork.
 Carbon fiber steering tube please notify.
MATERIAL: AL6061-T6
SPEC: ID $28.6+0.1+0.4$ x OD $\varnothing 34$ mm / ID $28.6+0.1+0.4$ x OD $\varnothing 36$ mm
H: OD $\varnothing 34 / 50, 100, 110, 120, 130, 140, 150, 160, 180, 200$ mm
 OD $\varnothing 36 / 50, 100, 110, 120, 130, 140, 150, 170, 200$ mm
COLOR: Sand blast black, silver, Black, Silver, As Order



ATR-28.6-5 30-03
 Alloy taper spacer.
 SPEC: ID $\varnothing 28.6$, OD-TOP $\varnothing 32.5$ mm
 H: 5 / 10mm
 COLOR: As Order
 OPTION: OD-BOTTOM $\varnothing 34 / \varnothing 35 / \varnothing 36$ mm



ACE-28.6-H **BEST SELLER**
ACE-31.8-H 31-02
 Carbon spacer.
P.A.T ED
SPEC:
 ACE-28.6-H (ID $\varnothing 28.8$ x OD $\varnothing 34$)
 ACE-31.8-H (ID $\varnothing 32.0$ x OD $\varnothing 38.8$)
 H: As Order
COLOR: 3K, UD



ARK-25.4-H
ARK-28.6-H 31-03
 Alloy spacer.
SPEC: ARK-25.4-H (ID $\varnothing 25.4$ x OD $\varnothing 32$)
 ARK-28.6-H (ID $\varnothing 28.6$ x OD $\varnothing 35$)
 H: As Order
COLOR: As Order



BEST SELLER
AC-25.4-H / AC-28.6-H
AC-31.8-H / AC-38.1-H 30-04
 Carbon spacer.
SPEC: AC-25.4-H (ID $\varnothing 25.6 \pm 0.2$ x OD $\varnothing 31.5$)
 AC-28.6-H (ID $\varnothing 28.8 \pm 0.2$ x OD $\varnothing 34$)
 AC-31.8-H (ID $\varnothing 32.0 \pm 0.2$ x OD $\varnothing 38.8$)
 AC-38.1-H (ID $\varnothing 38.3 \pm 0.2$ x OD $\varnothing 45.2$)
 H: As Order
COLOR: 3K, UD



LONG CARBON FIBER SPACER 30-05
 Carbon Long fibers with nylon Injection material, can use and Create carbon high texture lightweight products. For more details please contact our engineers.
MATERIAL: Long carbon fiber-reinforced PA12 resin
COLOR: UD Surface, UD with painting
 Custom design available

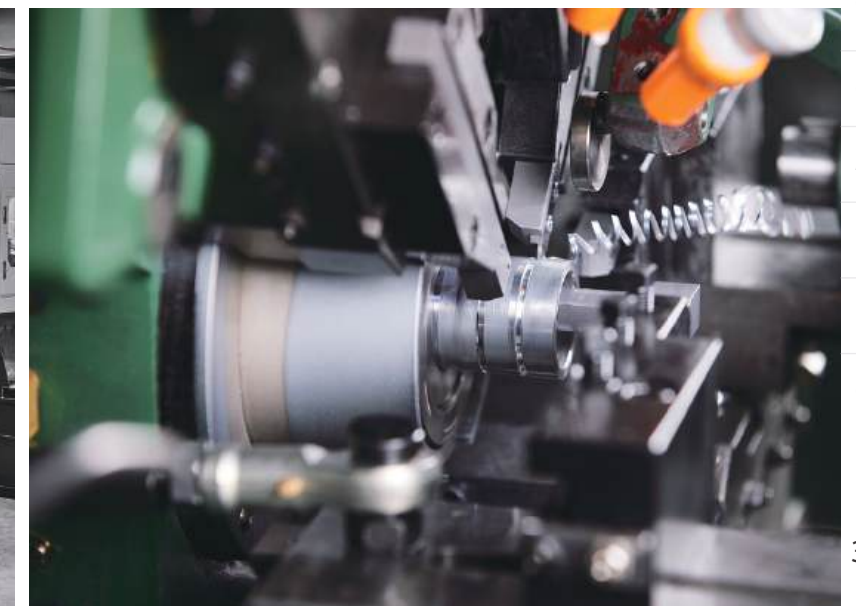

- THRU AXLE
- QUICK RELEASE
- SEAT CLAMP
- TOP CAP
- HEADSETS PARTS**
- CRANK SET
- CHAINRING SYSTEM
- E-BIKE SYSTEM
- ROLLER KIT SERIES
- BMX SERIES
- CHAINRING PARTS
- CHAIN GUIDE SYSTEM
- BRAKE SYSTEM
- SEATPOST
- STEM SYSTEM
- HANDLEBAR
- AEROBAR SYSTEM
- COMPUTER MOUNT
- CAGE
- ACCESSORIES
- FITTING EQUIPMENT
- PEDALS
- OUTDOOR GEAR

CRANK SET



CK-GRA

33-01

SRM Spider PowerMeter with rechargeable system.
MATERIAL: SPINDLE: AL 2024
 CHAINRING: AL7075-T651
 CRANK: AL6066-T6 / Carbon fiber
CRANK LENGTH: AL6066-T6: 145, 147.5, 150, 152.5, 155, 157.5, 160, 162.5, 165, 167.5, 170, 172.5, 175mm
 Carbon fiber: 145, 150, 155, 160, 165, 167.5, 170, 172.5, 175mm
GEAR COMBINATION: 34/50T, 36/52T, 39/53T, 42/54T, 42/55T
COLOR: S.B Black



ADP-FIT-CZ

33-02

Precision CNC machines fitting bike sizing cranks.
CRANK LENGTH: 145, 150, 155, 160, 165, 167.5, 170, 172.5, 175, 177.5, 180mm
AXLE: 24mm / 30mm
MATERIAL: CRANK: AL6061-T6
 AXLE: AL 2024
CHAINRING: Single 46T



CX-MUTI

33-03

Fix SHIMANO® crankset with special chainring bolt.
MATERIAL: AL7075-T651 full CNC made
P.C.D.: Ø110mm
TEETH: 34T & 50T / 36T & 52T / 39T & 53T

Option



CX-MUTI-5800: For SHIMANO® FC-5800 crank / W/I T30 chainring bolt
CX-MUTI-6800: For SHIMANO® FC-6800 crank / W/I T30 chainring bolt
CX-MUTI-R7000: For SHIMANO® FC-R7000 crank / W/I T30 chainring bolt
CX-MUTI-R8000: For SHIMANO® FC-R8000 crank / W/I T30 chainring bolt
CX-MUTI-R9000: For SHIMANO® FC-R9000 crank / W/I T30 chainring bolt
CX-MUTI-R9100: For SHIMANO® FC-R9100 crank / W/I T30 chainring bolt



THRU AXLE

QUICK RELEASE

SEAT CLAMP

TOP CAP

HEADSETS PARTS

CRANK SET

CHAINRING SYSTEM

E-BIKE SYSTEM

ROLLER KIT SERIES

BMX SERIES

CHAINRING PARTS

CHAIN GUIDE SYSTEM

BRAKE SYSTEM

SEATPOST

STEM SYSTEM

HANDLEBAR

AEROBAR SYSTEM

COMPUTER MOUNT

CAGE

ACCESSORIES

FITTING EQUIPMENT

PEDALS

OUTDOOR GEAR

CHAINRING SYSTEM



TRSK 34-01

For SHIMANO® cassette.

MATERIAL:
Cold forged Cr-Mo steel (ASM4140)
Heat treated (Harden+double temple)
N.E.N finish
TEETH: 12T - 20T
T: 3/32" (1.8mm)



TRSK-F 34-02

For SHIMANO® cassette.

MATERIAL:
Cold forged Cr-Mo steel (ASM4140)
Heat treated (Harden+double temple)
N.E.N finish
TEETH: 13T - 18T, 20T
H: 7mm
T: 3/32" (1.8mm)



TRST 34-03

MATERIAL:
Cold forged Cr-Mo steel (ASM4140)
Heat treated (Harden+double temple)
N.E.N finish
TEETH: 13T - 23T (1.37 x 24T (R) lock ring)
H: 7mm
T: 3/32" (1.8mm), 1/8" (3mm)
OPTION: Add 1.29 x 24T (L) lock ring,
Surface ED finished



TRSK-66 34-04

For SHIMANO® cassette.

MATERIAL:
Cold forged Cr-Mo steel (ASM4140)
Heat treated (Harden + double temple)
N.E.N finish
TEETH: 16T - 23T
WEIGHT: 56g/pcs (16T)
OPTION: Black ED

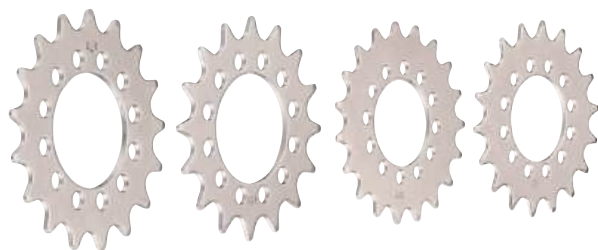

TRSK-R6 34-05

For disc hub 6 hole.

MATERIAL:
Cold forged Cr-Mo steel (ASM4140)
Heat treated (Harden + double temple)
N.E.N finish
TEETH: 16T - 23T
WEIGHT: 29.5g/pcs (16T)
OPTION: Black ED



TRSK-TY 34-06

For SHIMANO® cassette.

MATERIAL:
Cold forged Cr-Mo steel (ASM4140)
Heat treated (Harden + double temple)
N.E.N finish
TEETH: 12T, 15T - 23T
WEIGHT: 62.5g/pcs (18T)

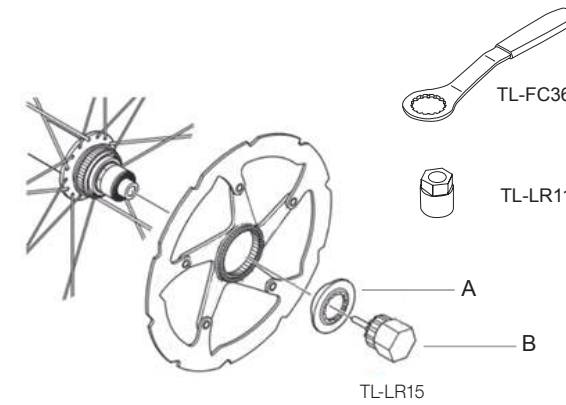

	Internally serrated type	Externally serrated type	Internally and externally serrated type
A. Disc brake rotor fixing lock ring From Mr.control	M-SH44	M-SH1521-CR	M-SH3611
B. Lock ring tightening tool From SHIMANO®	TL-LR15 Adjustable wrench	TL-FC36	TL-FC36/TL-LR11 Adjustable wrench



M-SH1521-CR 35-01

For SHIMANO® center-lock.
15 / 20mm thru-axle disc system hub.

MATERIAL: Cr-Mo heat treated
SPEC: OD Ø44 x ID Ø27
COLOR: ED finished



M-SH3611 BEST SELLER 35-02

Lock ring for SHIMANO® center-lock.
15 / 20mm thru-axle disc system hub.

MATERIAL: AL6061
SPEC: OD Ø44 x ID Ø27
COLOR: As Order



M-SH44 35-03

For SHIMANO® center-lock disc system hub.

MATERIAL: AL6061
SPEC: OD Ø44
COLOR: As Order



LOCK RING 35-04

MATERIAL: Cr-Mo heat treated
SPEC: 1.29 x 24T (L)



M-HUB 35-05

Hub ring nut (free wheel).

MATERIAL: AL6061-T651
OPTION: 11T (OD: Ø35.5)
12T (OD: Ø38)



AR-HUB-2 35-06

For SHIMANO® hub.
11 speed change to 10 speed.

MATERIAL: AL6061
SPEC: OD Ø38.8
H: 2mm



AR-HUB 35-07

Spacer for cassette hub.

MATERIAL: AL6061
SPEC: OD Ø38.8
H: As Order



SSP-SET-T BEST SELLER 35-08

A: TRSK (12T-18T) choose 1 pcs
B: AR-HUB 10mm x 2 pcs
5mm x 1 pcs
3mm x 4 pcs
C: M-HUB (12T) x 1



▲ 4-Axis Milling Machine

▲ Automatic Cam Lathe For Spacer And Top Cap...

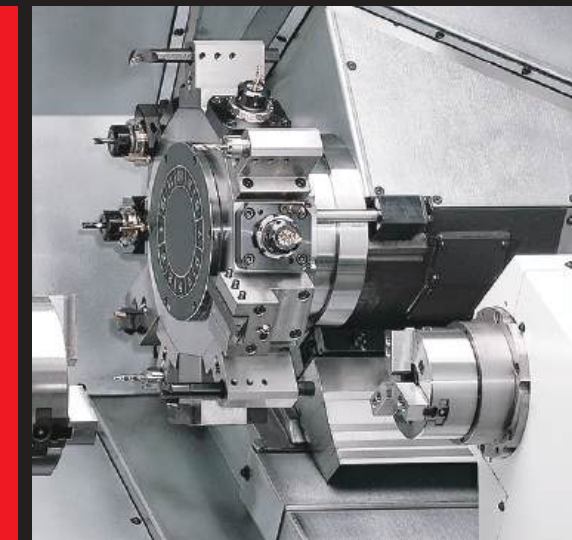

▼ 3+2-Axis Machine

▼ Swiss Lathe

▲ CNC Turning Lathe



E-BIKE SYSTEM



M-LK-BSH
M-LK-BSH-OF3
M-LK-BSH-OF6 38-01

Lock ring with guard for E-Bike BOSCH® system.

MATERIAL: AL6061-T6
SPEC:
M-LK-BSH-OF3 = offset 3mm
M-LK-BSH-OF6 = offset 6mm
TEETH: 16T (14T - 16T) / 20T (17T - 20T)
COLOR: As Order



TRSK-BSH-NW
TRSK-BSH-NWOF3
TRSK-BSH-NWOF6 38-02

For BOSCH® system Narrow Wide chainring.

MATERIAL: Cr-Mo steel (ASM 4140) heat treated
SPEC:
TRSK-BSH-NW = 0 offset
TRSK-BSH-NWOF3 = offset 3mm for OLD 142mm
TRSK-BSH-NWOF6 = offset 6mm for OLD 148mm
TEETH: 14T, 16T, 18T, 20T
OPTION: N.E.N finish or ED, BK

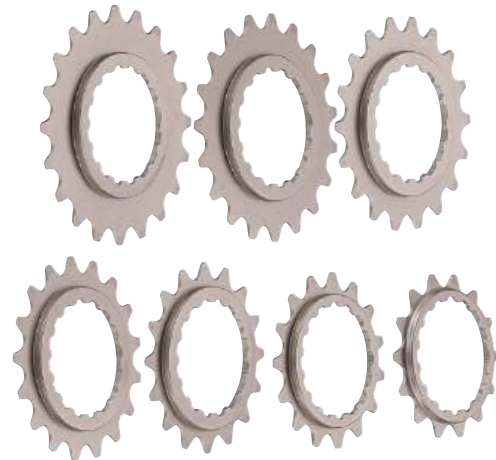

TRSK-BSH
TRSK-BSH-OF3
TRSK-BSH-OF6 38-03

For BOSCH® system chainring.

MATERIAL: Cr-Mo steel (ASM 4140) heat treated
SPEC:
TRSK-BSH = 0 offset
TRSK-BSH-OF3 = offset 3mm for OLD 142mm
TRSK-BSH-OF6 = offset 6mm for OLD 148mm
TEETH: 14T, 15T, 16T, 17T, 18T, 19T, 20T
OPTION: N.E.N finish or ED, BK

CUSTOM DESIGN AVAILABLE

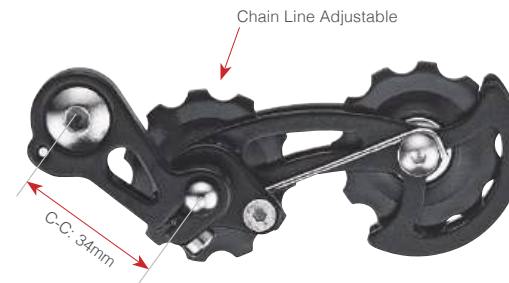

SSP-12US-1 (34) 39-01

Two pulley design.

MATERIAL: AL6061-T6
Outline spring design
T: 12T - 13T



SSP-12US-1 (68) 39-02

Two pulley design.

MATERIAL: AL6061-T6
Outline spring design
T: 19T - 20T



SSP-12US-1 (51) 39-03

Two pulley design.

MATERIAL: AL6061-T6
Outline spring design
T: 16T - 18T

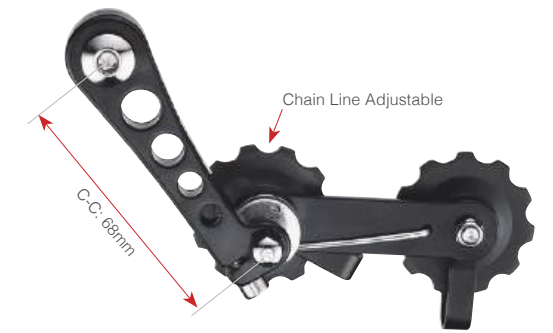

SSP-12-1 39-04

MATERIAL: AL6061-T6
T: 16T - 20T



SSP-11-1 39-05

MATERIAL: AL6061-T6
Outline spring design
T: 16-20T



SSP-11 / SSP-11-V1 39-06

MATERIAL: AL6061-T6
Built-in spring design
T: 16-20T



SSP-FOOT-1 39-07

Bearing roller type.
For single speed.

MATERIAL: AL6061-T6 CNC made



THRU AXLE

QUICK RELEASE

SEAT CLAMP

TOP CAP

HEADSETS PARTS

CRANK SET

CHAINRING SYSTEM

E-BIKE SYSTEM

ROLLER KIT SERIES

BMX SERIES

CHAINRING PARTS

CHAIN GUIDE SYSTEM

BRAKE SYSTEM

SEATPOST

STEM SYSTEM

HANDLEBAR

AEROBAR SYSTEM

COMPUTER MOUNT

CAGE

ACCESSORIES

FITTING EQUIPMENT

PEDALS

OUTDOOR GEAR

ROLLER KIT SERIES

SHIMANO®	SYSTEM	ULTEGRA						105	105
		NEW						New	
		MODEL	R8000	R8000	R8050 (DI2)	R6800	R6870 (DI2)	R7000	R5800
Mr.Control	ITEM	RD-R8000-SS	RD-R8000-GS	RD-R8050	RD-R6800-SS	RD-R6800-GS	RD-R6870	RD-R7000	RD-R5800
SSP-15	11T + 15T	-	-	-	MAX 36T	MAX 36T	-	-	-
SSP-152X	15T + 15T	-	-	-	MAX 36T	MAX 36T	-	-	-
SSP-CARBON	12T + 16T	-	-	-	MAX 36T	MAX 36T	-	-	-
SSP-105-152X	15T + 15T	-	-	-	-	-	-	-	MAX 28T
SSP-R8050-1216	12T + 16T	MAX 30T	MAX 34T	MAX 32T	-	-	-	-	-
SSP-R91-1216	12T + 16T	MAX 30T	MAX 34T	-	-	-	-	-	-
SSP-R91-CO-1216	12T + 16T	MAX 30T	MAX 34T	MAX 32T	-	-	-	-	-

SHIMANO®	SYSTEM	DURA-ACE						105
		NEW				DURA-ACE	ULTEGRA	105
		MODEL	R9100	R9150 (DI2)	R9000	R9070 (DI2)	R9250	R8150
Mr.Control	ITEM	RD-R9100-SS	RD-R9150-SS	RD-R9000	RD-R9070	RD-R9250	RD-R8150	RD-R7150
SSP-15	11T + 11T	-	-	MAX 32T	MAX 28T	-	-	-
SSP-152X	15T + 15T	-	-	MAX 28T	MAX 28T	-	-	-
SSP-CARBON	12T + 16T	-	-	MAX 32T	MAX 25T	-	-	-
SSP-105-152X	15T + 15T	-	-	-	-	-	-	-
SSP-R8050-1216	12T + 16T	-	-	-	-	-	-	-
SSP-R91-1216	12T + 16T	MAX 30T	MAX 30T	-	-	-	-	-
SSP-R91-CO-1216	12T + 16T	MAX 30T	MAX 30T	-	-	-	-	-
SSP-SR98-ROLLER KIT	12T+16T	-	-	-	-	MAX34T	MAX34T	-
SSP-SR71-ROLLER KIT	12T+16T	-	-	-	-	-	-	MAX36T

SRAM®	SYSTEM	RED		FORCE	RIVAL	
		MODEL	RED® e-TAP	RED®	Force®	Rival®
		ITEM	RED® e-TAP	RED®	Force®	Rival®
SSP-SR152X	15T + 15T	-	MAX 28T	MAX 28T	MAX 28T	
SSP-TAP152X	15T + 15T	MAX 28T	-	-	-	

SRAM®	SYSTEM	AXS			AXS XPLR			
		MODEL	RED®	Force®	Rival®	RED®	Force®	Rival®
		Mr.Control	MODEL	RED®	Force®	Rival®	RED®	Force®
SSP-AX-ROLLER KIT	12T+16T	MAX 36T	MAX 36T	MAX 36	MAX 44T	MAX 44T	MAX 33T	



SSP-AX-ROLLER KIT 40-01

MATERIAL: AL6061-T6 Cage
AL7075-T651 Pulley
SPEC: SRAM® AXS derailleur system
COLOR: As Order
WEIGHT: 67g/set
OPTION: Ceramics ball bearing



SSP-SR98-ROLLER KIT 40-02

MATERIAL: Carbon Cage
AL7075-T651 Pulley
SPEC: 12T+16T
FOR: SHIMANO® R9250 / R8150
COLOR: 3K Carbon
OPTION: Ceramics ball bearing.



NEW SSP-SR71-ROLLER KIT 40-03

MATERIAL: Carbon Cage/ AL7075-T651 Pulley
SPEC: 12T+16T
FOR: SR71- SHIMANO R7150(105)
COLOR: 3K Carbon
OPTION: Ceramics ball bearing.



SSP-R91-CO ROLLER KIT 41-01

Oversize derailleur cage with 12T upper and 16T lower pulley. With carbon plate. Pulley are full CNC made from AL7075-T651 with Cr-Mo or steel bearing. Compatible with SHIMANO® RD 9150 / RD 8050 / RD 9100SS.

MATERIAL: Carbon Cage & AL7075-T651 Pulley
SPEC: Fit SHIMANO® RD 8050 / RD 9150 / RD 9100SS
COLOR: As Order
OPTION: Ceramics ball bearing
Not available in Japan



SSP-R8050 ROLLER KIT 41-02

Oversize derailleur cage with 12T upper and 16T lower pulley. Pulley are full CNC made from AL7075-T651 with Cr-Mo or steel bearing. Compatible with SHIMANO® RD 8050 / RD 8000.

MATERIAL: AL6061-T6 Cage
AL7075-T651 Pulley
SPEC: Fit SHIMANO® RD 8050 / RD 8000
COLOR: As Order
OPTION: Ceramics ball bearing
Not available in Japan



SSP-R91-1216 ROLLER KIT 41-03

Oversize derailleur cage with 12T upper and 16T lower pulley. Pulley are full CNC made from AL7075-T651 With Cr-Mo or steel bearing. Compatible with SHIMANO® RD 9100SS.

MATERIAL: AL6061-T6 Cage
AL7075-T651 Pulley
SPEC: Fit SHIMANO® RD 9100-SS
Fit SHIMANO® RD 9150-SS
OPTION: Ceramics ball bearing
Not available in Japan



SSP-CARBON ROLLER KIT 41-04

12T and 16T R.D over size pulley cage for reduced drivetrain friction with Cr-Mo steel bearing.

MATERIAL: Carbon Cage & AL7075-T651 Pulley
FOR: Fit SHIMANO® RD 9000 / 9070 / 6800 / 6870
COLOR: 3K carbon
WEIGHT: 60g/set
OPTION: Ceramics ball bearing
Not available in Japan



SSP-SR152X ROLLER KIT 41-05

15T and 15T R.D over size pulley cage for reduced drivetrain friction with Cr-Mo steel bearing.

MATERIAL: AL6061-T6 Cage
AL7075-T651 Pulley
FOR: Fit SRAM® RED / FORCE / RIVAL
COLOR: Black
WEIGHT: 93g/set
OPTION: Ceramics ball bearing
Not available in Japan



SSP-105-152X ROLLER KIT 41-06

15T and 15T R.D over size pulley cage for reduced drivetrain friction with Cr-Mo steel bearing.

MATERIAL: AL6061-T6 Cage
AL7075-T651 Pulley
FOR: Fit SHIMANO® 5800
COLOR: Black
WEIGHT: 88g/set
OPTION: Ceramics ball bearing
Not available in Japan



SSP-15 ROLLER KIT 41-07

11T and 15T R.D over size pulley cage for reduced drivetrain friction with Cr-Mo steel bearing.

MATERIAL: AL6061-T6 Cage
AL7075-T651 Pulley
FOR: Fit SHIMANO® 9000 / 9070 / 6800 / 6870
COLOR: Black
WEIGHT: 88g/set
OPTION: Ceramics ball bearing
Not available in Japan



SSP-152X ROLLER KIT 41-08

15T and 15T R.D over size pulley cage for reduced drivetrain friction with Cr-Mo steel bearing.

MATERIAL: AL6061-T6 Cage
AL7075-T651 Pulley
FOR: Fit SHIMANO® RD 9000 / 9070 / 6800 / 6870
COLOR: Black
WEIGHT: 84g/set
OPTION: Ceramics ball bearing
Not available in Japan

BMX SERIES



PEG-COMBO

42-01

Cr-Mo peg with EMS (SWISS®) harden nylon sleeve.
For both park and street.

MATERIAL: ASM 4130 heat treatment Cr-Mo peg
With EMS (SWISS®) harden nylon sleeve
SPEC: Ø40 x (L)107mm for combo use
Ø33.6 x (L)104.5mm for only Cr-Mo-peg use
With 5 anti rotate pin position
COLOR: Cr-Mo peg cp / Red / Blue / Black
Nylon sleeve blue / Red / Black / White
WEIGHT: Combo 203g / Cr-Mo 165.5g
OPTION: Solid color or transparent color



PEG-GL

42-02

MATERIAL: EMS (SWISS®) super harden nylon
SPEC: Ø40 x (L)100mm
WEIGHT: 90g/pcs
COLOR: Blue, Yellow, White, Red, Violet,
Black, Green, Orange, Pink
OPTION: With Mr.control sticker



PEG-4130-F4-L

42-03

MATERIAL: ASM 4130 heat treatment Cr-Mo With CNC
finished
SPEC: Ø34 x (L)110mm with 3/8 adapter
With 4 anti rotate pin position
WEIGHT: 180g/pcs



PEG-4130-F4

42-04

MATERIAL: ASM 4130 Cr-Mo cold forged heat treatment
CNC finished
SPEC: Ø34 x (L)95mm
WEIGHT: 160g/pcs (With lock hold)



PEG-4130-F

42-05

MATERIAL: ASM 4130 Cr-Mo cold forged
SPEC: Ø35 x (L)80mm, Ø35 x (L)90mm
WEIGHT: 200g/pcs



PEG-MINI

42-06

For pegless hub protect axle.
MATERIAL: ASM4130 heat treatment
cold forged CNC made
SPEC: 3/8 x 26T, M14 x 1.0
LENGTH: 35mm
WEIGHT: 65g/pcs



M-AI-3/8 / M-AI-14

42-07

MATERIAL: AL7075-T651 CNC made
SPEC: M14 x 1.0 & 3/8 x 26T
WEIGHT: 7g (14), 11g (3/8")
COLOR: As Order



RH-SP28-S

43-01

Alloy chain adjuster.

SPEC: Ø14 x14w, Ø10 x10w
S: Single guide
Shorter for small dropout



RH-SP25-S

43-02

Alloy chain adjuster.

SPEC: Ø14 x14w, Ø10 x10w
S: Single guide
Shorter for small dropout



RH-MG

43-03

Chain adjuster.

MATERIAL: AL6061-T6
OPTION: 10mm, 14mm



RH-MGC

43-04

Chain adjuster.

MATERIAL: AL6061-T6 CNC finished
OPTION: 10mm, 14mm



RH-SP38-S

43-05

Alloy chain adjuster.

SPEC: Ø14 x14w, Ø10 x10w
Shorter for small dropout



RH-SP25

43-06

Alloy chain adjuster.

SPEC: Ø14 x14w, Ø10 x10w
Shorter for small dropout



RH-AT09

43-07

Chain adjuster.

For 10mm or 14mm dropout.

MATERIAL: AL6061-T6
OPTION: 3 different length bolt
12mm, 15mm, 18mm



RH-AT09-H

43-08

Chain adjuster.

For 10mm or 14mm dropout.

MATERIAL: AL6061-T6 CNC finished
OPTION: 3 different length bolt
12mm, 15mm, 18mm



RH-STAR

43-09

Chain adjuster.

For 10mm dropout.

MATERIAL: AL6061-T6



RH-ARROW

43-10

Chain adjuster involute profile
design.
For 14mm dropout.

MATERIAL: AL6061-T6



RH-112A

43-11

Chain adjuster.
For 5mm, 7mm dropout.

MATERIAL:
Steel bolt + AL6061-T6 nut
AXLE: 10mm



RH-112-E

43-12

Chain adjuster.
For 5mm dropout.

MATERIAL: Steel bolt
AXLE: 10mm



RH-RD10

43-13

Alloy adjuster.
Special design available.

MATERIAL: AL6061-T6

CHAINRING PARTS

ITEM	P.C.D SPEC		CHAINRING SPEC
CX 1042S	104mm	Standard	30 / 32 / 34 / 36 / 38 / 40 / 42 / 44 / 46 / 48
CX 1042S OV	104mm	Standard	34 / 36 / 38 / 40 / 42 / 44 / 46 / 48
CX 96S	96mm	Standard	32 / 34 / 36 / 38 / 40 / 42 / 44 / 46 / 48
CX XTR 96S	96mm	XTR M9000	30 / 32 / 34 / 36 / 38 / 40 / 42 / 44 / 46 / 48
CX XTR 96S OV	96mm	XTR M9000	34 / 36 / 38 / 40 / 42 / 44 / 46 / 48
CX 130S	130mm	Standard	38 / 40 / 42

ITEM	P.C.D SPEC		CHAINRING SPEC
CX 110S	110mm	Standard	38 / 40 / 42
CX 110S 68	110mm	FC6800 / ULTEGRA	40 / 42 / 44 / 46 / 48
CX 110S 58	110mm	FC5800 105	40 / 42 / 44 / 46 / 48
CX 120S	120mm	SRAM® Standard	36 / 38 / 40
CX 76X115	76mm	SRAM® XX1 System	30 / 32 / 34 / 36
CX GX94S	94mm	SRAM® GX Crank System	32 / 34 / 36
CX GXPS	-	GXP System	30 / 32 / 34 / 36 / 38



CX-XTR-DIR

44-01

Narrow Wide chainring for XTR / XT 12 speed crank.

MATERIAL: AL7075-T651
TEETH: 30T / 32T / 34T / 36T
SPEC: XTR/XT Direct mount

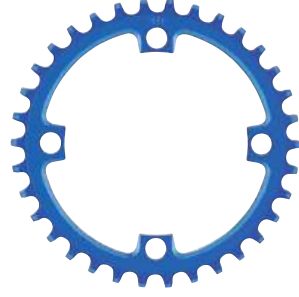

CX-1042S

44-02

MATERIAL: AL7075-T651
P.C.D: Ø104mm
TEETH: 30T / 32T / 34T / 36T / 38T / 40T
HEIGHT: 4mm
WEIGHT: 46.5g/pcs (34T)



CX-XTR-96S

44-03

Narrow Wide chainrings for XTR M9000 / M9020 11 speed crank with custom made crank cover caps.

MATERIAL: AL7075-T651
P.C.D: Ø96mm
TEETH: 30T / 32T / 34T / 36T
HEIGHT: 4mm
WEIGHT: 46g/pcs (34T)
CRANK COVER CAP MATERIAL: AL6061-T6 (4pcs)
CHAINRING BOLT MATERIAL: AL7075-T651 (4pcs)



CX-96S

44-04

Full CNC made narrow wide chainring for 1x system. For P.C.D 96mm x 4 arms standard.

MATERIAL: AL7075-T651 CNC made
P.C.D: Ø96mm
TEETH: 32T, 34T, 36T, 38T
SPEC: 52g/pcs (34T)

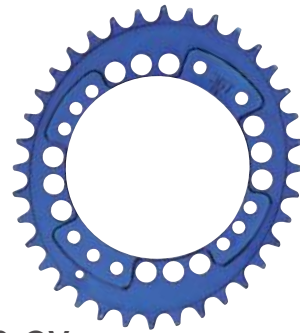

CX-1042S-OV

44-05

Oval shape design make the spin cycle a lot smoother and easier on the legs while climbing. Adjust the oval ring in 3 position to increase it's effect. Full CNC made narrow wide chainring for 1x system.

MATERIAL: AL7075-T651
P.C.D: Ø104mm
TEETH: 34T, 36T
WEIGHT: 79g/pcs (34T)



NEW CX-TD-DIR

45-01

Narrow wide chainring for SRAM® T type crank.

MATERIAL: AL7075-T651
TEETH: 30T / 32T / 34T / 36T
SPEC: SRAM® T type direct mount 8-bolt
OFFSET: 3mm for chainline 55mm



NEW CX-CR-L

45-02

MATERIAL: CR-MO steel heat treatment
TEETH SPEC: 25T / 28T / 30T
HEIGHT: 3mm
COLOR: ED BK



NEW CX-E-MOTO

45-03

E motor chainring with mud remove design on teeth shape.

FIT: 420 chain
MATERIAL: AL7075-T651
P.C.D: Ø68.5 Hole
TEETH: 58T / 60T / 62T / 64T
COLOR: As Order
Custom design available



**FTP-36 / FTP-53H
FTP-53E / FTP-0352**

45-04

Chain catcher for Road bike.

FIX: 36T - 46T (FTP-36)
34T - 50T, 39T - 53T (FTP-53)
Triple (FTP-0352)
WEIGHT: 10g/pcs (FTP-36), 12g/pcs (FTP-53E)
11g/pcs (FTP-53H), 9.2g/pcs (FTP-0352)
COLOR: As Order



FTP-AERO

45-05

Cold forged AL6061-T6.

FIX: 34T - 50T & 39T - 53T
WEIGHT: 33g/pcs

CHAIN GUIDE SYSTEM



CUSTOM DESIGN AVAILABLE

Qualified with some country rule as chainring have to cover from centreline to back at least 25mm.

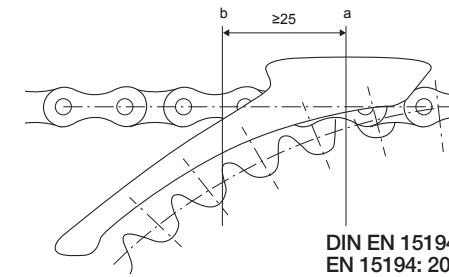

Easy to set up the top guide position



DESIGN:
CH-MINI UPPER
CH-MED2 UPPER



CH-E8-MED2



CH-E8-MED



CH-E8-MINI

Standards compliant EN 15194: 2017-12

CH-E8-MED2 CH-E8-MED CH-E8-MINI

47-01

Design for SHIMANO® E8000 system.
Easy to set up the top guide position.

MATERIAL: AL6061-T6
SPEC: E8000
RANGE: 30T - 40T
COLOR: As Order
OPTION: Spacer thickness



2.5mm



5mm



0.5mm



CH-GN4-MED2



CH-GN4-MED



CH-GN4-MINI

Standards compliant EN 15194: 2017-12

CH-GN4-MED2 CH-GN4-MED CH-GN4-MINI

47-02

For BOSCH® Gn4 chain guide.

MATERIAL: AL6061-T6
RANGE: 32T - 38T
COLOR: As Order
OPTION: Spacer thickness



2.5mm

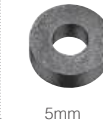

5mm



0.5mm



CH-BOSCX-MED2



CH-BOSCX-MED



CH-BOSCX-MINI

Standards compliant EN 15194: 2017-12

CH-BOSCX-MED2 CH-BOSCX-MED CH-BOSCX-MINI

47-03

For BOSCH® CX chain guide.

MATERIAL: AL6061-T6
SPEC: BOSCH® CX
RANGE: 32T-38T
COLOR: As Order
OPTION: Spacer thickness



2.5mm



5mm



0.5mm



THRU AXLE

QUICK RELEASE

SEAT CLAMP

TOP CAP

HEADSETS PARTS

CRANK SET

CHAINING SYSTEM

E-BIKE SYSTEM

ROLLER KIT SERIES

BMX SERIES

CHAINING PARTS

CHAIN GUIDE SYSTEM

BRAKE SYSTEM

SEATPOST

STEM SYSTEM

HANDLEBAR

AEROBAR SYSTEM

COMPUTER MOUNT

CAGE

ACCESSORIES

FITTING EQUIPMENT

PEDALS

OUTDOOR GEAR

CHAIN GUIDE SYSTEM

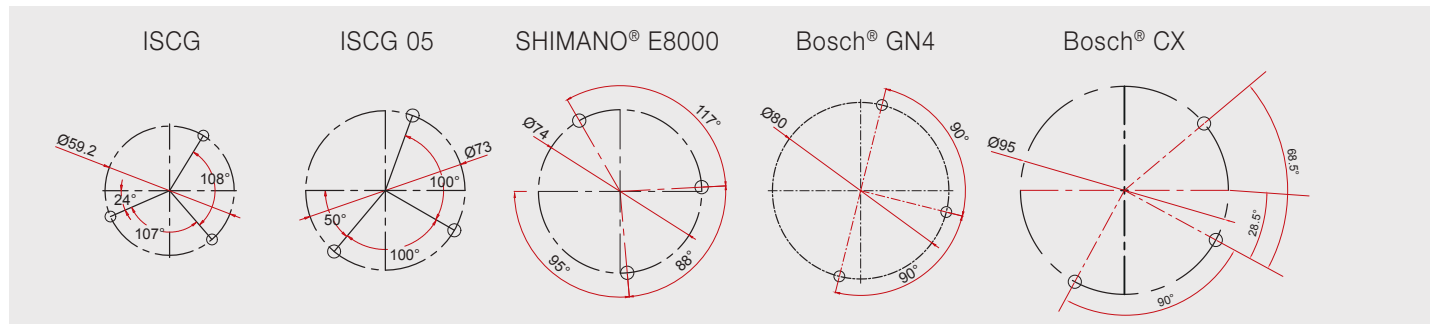

CUSTOM DESIGN AVAILABLE



NEW
CH-DLG9T 49-01

Chain guard with pulley style and bashguard.

MATERIAL: AL-6061T6
SPEC: ISCG 05
TEETH: 28-34T
COLOR: BLACK



NEW
CH-DLR 49-02

Chain guard with roller style and bashguard.

MATERIAL: AL-6061T6/NYLON
SPEC: ISCG 05
TEETH: 28-34T
COLOR: BLACK



CH-R1-MINI 48-01

Design for mtb 1x system drivetrain.
Carbon long fibers with nylon Injection.
Without ADP-N.
Easy to set up the top guide position.

MATERIAL: Carbon with nylon
SPEC: ISCG-05
RANGE: 30T - 36T
WEIGHT: 28g/set



CH-A1-MINI 48-02

Design for mtb 1x system drivetrain.
Without ADP-N.
Easy to set up the top guide position.

MATERIAL: AL6061-T6 forged
SPEC: ISCG-05
RANGE: 30T - 38T
WEIGHT: 35.8g/set
COLOR: As Order



CH-A1-MED 48-03

Design for 1x system drivetrain with mid size plastic cage W/O ADP-N.

MATERIAL: AL6061-T6
SPEC: ISCG-5
RANGE: 32T - 38T
WEIGHT: 38g/set
COLOR: As Order



CH-DDS1-MINI 48-04

Chain guard for 1 by 9, 10, 11 speed drivetrain.

MATERIAL: AL6061-T6 full CNC made
SPEC: Direct mount type guard
RANGE: 30T - 38T
COLOR: As Order



CH-ESG 49-03

Chain guide with bash guard.
Bash guard made by strong swiss plastic.
With ADP-N for E-type BB mount.

MATERIAL: AL6061-T6
SPEC: ISCG or ISCG-05
RANGE: 32T - 38T
WEIGHT: 240g/set
COLOR: As Order



NEW
CH-G23-MED2 49-04

For MTB 1 X system drivetrain with bash guard.

MATERIAL: AL6061-T6/ Nylon
SPEC: ISCG 05
TEETH: 28-34T
COLOR: As Order



CH-CM2 48-05

Chain guide for MTB 1x9 or 1x10 drivetrain.
With CH-EX plastic upper guard.

MATERIAL: AL6061-T6
DIA: Ø34.9 With adapter to Ø31.8
COLOR: Black
Chainline adjustable



CH-ES-32 49-05

Chain guide with bash guard, light weight design, bash guard made by swiss material.

MATERIAL: AL6061-T6
SPEC: ISCG-05
RANGE: 28T - 32T
COLOR: As Order



THRU AXLE

QUICK RELEASE

SEAT CLAMP

TOP CAP

HEADSETS PARTS

CRANK SET

CHAINRING SYSTEM

E-BIKE SYSTEM

ROLLER KIT SERIES

BMX SERIES

CHAINRING PARTS

CHAIN GUIDE SYSTEM

BRAKE SYSTEM

SEATPOST

STEM SYSTEM

HANDLEBAR

AEROBAR SYSTEM

COMPUTER MOUNT

CAGE

ACCESSORIES

FITTING EQUIPMENT

PEDALS

OUTDOOR GEAR

CHAIN GUIDE SYSTEM



CH-ER 50-01

Must added chainring protector.
With ADP-N for E-type BB mount.

MATERIAL: AL6061-T6
SPEC: ISCG or ISCG-05
FIX: 32T - 38T



Anti-Chainsuck



CH-ES3 50-02

Chainring protector for single speed to prevent rocks hitting on the chainring.
With ADP-N for E-type BB mount.

MATERIAL: AL6061-T6
SPEC: ISCG or ISCG-05
RANGE: 28T - 40T
WEIGHT: 142g/set
COLOR: As Order

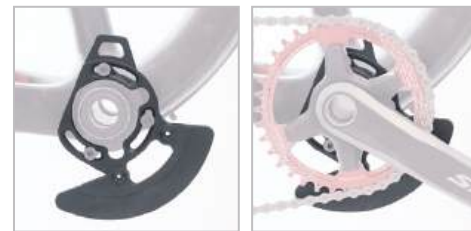

CH-EX 50-03

With ADP-N for E-type BB mount.

MATERIAL: AL6061-T6
SPEC: ISCG or ISCG-05
FIX: 32T - 38T



CH-EX-S 50-04

With ADP-N for E-type BB mount.

MATERIAL: Harden steel
SPEC: ISCG or ISCG-05
FIX: 32T - 38T
OPTION: ADP-N



CUSTOM DESIGN AVAILABLE



NEW CH-BB-MU 51-01

BB mount tensioner.

MATERIAL: AL6061-T6
SPEC: Customization
COLOR: Black



CH-MTS 51-02

Chain guide for MTB 1x9 or 1x10 drivetrain.
With CH-EX plastic upper guard.
BB mount version only.

MATERIAL: AL6061-T6
COLOR: Black
Includes spacers for chainline adjustable



CH-EMR 51-03

Roller type design. (For double chainring)

MATERIAL: AL6061-T6 CNC made
SPEC: ISCG or ISCG-05
FIX: 32T - 44T



CH-E8-EMR 51-04

Roller type design for SHIMANO® E8000 system.

MATERIAL: AL6061-T6
SPEC: E8000
RANGE: 30T - 40T
WEIGHT: 49g/set
COLOR: As Order



CH-2GC 51-05

Roller type design. (for double chainring)

MATERIAL: AL6061-T6 CNC made
SPEC: ISCG or ISCG-05 or E-type
FIX: 32T - 44T



CH-09 51-06

Rotating & floating chain tensioner



THRU AXLE

QUICK RELEASE

SEAT CLAMP

TOP CAP

HEADSETS PARTS

CRANK SET

CHAINRING SYSTEM

E-BIKE SYSTEM

ROLLER KIT SERIES

BMX SERIES

CHAINRING PARTS

CHAIN GUIDE SYSTEM

BRAKE SYSTEM

SEATPOST

STEM SYSTEM

HANDLEBAR

AEROBAR SYSTEM

COMPUTER MOUNT

CAGE

ACCESSORIES

FITTING EQUIPMENT

PEDALS

OUTDOOR GEAR

CHAIN GUIDE SYSTEM



NEW
CH-CLD 52-01

MATERIAL: AL6061-T6
SPEC: Clamp Ø34.9, Ø31.8, Ø28.6 mm
COLOR: Black



ADP-N 52-02

Adapter for ISCG or ISCG05 to E-type BB mount.

MATERIAL: AL6061-T6
COLOR: As Order



CH-MINI UPPER-SV 52-03

Design for E-bike motor base, custom design available.

MATERIAL: Nylon



CH-CM1 53-01

Chain guard for 1 by 9, 10, 11 speed. With plastic upper guard.

MATERIAL: AL6061-T6
DIA: Ø34.9 With adapter to Ø31.8
COLOR: Black



CH-1042E 53-02

Design for 1x seattube mount system drivetrain with small size plastic cage to avoid chain drop for 1 by 9, 10, 11, 12 speed.

MATERIAL: AL6061-T6 forged
SPEC: Seattube Ø34.9 / Ø31.8
COLOR: As Order



CH-1042B 53-03

Design for 1x seattube mount system drivetrain with small size plastic cage to avoid chain drop for 1 by 9, 10, 11, 12 speed.

MATERIAL: AL6061-T6 forged
SPEC: Seattube Ø34.9 / Ø31.8
COLOR: As Order



CH-EX-FD 52-04

Low-profile, FD mount chain guard for 1X drivetrains. Alloy body, with a nylon guide that is easy to adjust and quiet on your chain.

MATERIAL: AL6066-T651 body / nylon cage
SPEC: FD mount system
RANGE: 32T - 58T
COLOR: Black
WEIGHT: 25g/set



CH-CM4-E 53-04

Chain guard for 1 by 9, 10, 11 speed. With plastic upper guard. Easy to set up the top guide position.

MATERIAL: AL6061-T6
DIA: Ø34.9 or Ø31.8
COLOR: Black
WEIGHT: 58.5g/set



CH-ES-LD 52-05

Low-profile, low direct mount chain guard for 1X drivetrains. Carbon injection body, with a nylon guide that is easy to adjust and quiet on your chain.

MATERIAL: Carbon body / nylon cage
SPEC: Low direct mount system
RANGE: 32T - 36T
COLOR: Black
WEIGHT: 17g/set



CH-CM4 53-05

Chain guard for 1 by 9, 10, 11 speed. With plastic upper guard.

MATERIAL: AL6061-T6
DIA: Ø34.9 With adapter to Ø31.8
COLOR: Black
WEIGHT: 57g/set
Chainline adjustable



BRAKE SYSTEM



BRK-AERO-V730-CNC

54-01

Fits GIANT® PROPEL.
Direct mount aero V brake.
Liner spring adjuster system.
Quick adjuster for different rim width.

MATERIAL: AL6061-T6
BRAKE SHOES: SWISS STOP® brake shoes
COLOR: As Order
WEIGHT: 260.5g/bike



BRK-AERO-V730-FG

54-02

Fits GIANT® PROPEL.
Direct mount aero V brake.
Liner spring adjuster system.
Quick adjuster for different rim width.

MATERIAL: Cold forged AL6061-T6
BRAKE SHOES: AMISHA® brake shoes
COLOR: As Order
WEIGHT: 285g/bike



CAMP-97C

55-01

MATERIAL: AL6066-T6 CNC made
DIMENSION: C-C 39-51mm (+2mm than normal)
WEIGHT: 310g/bike



CAMP-97C-L

55-02

MATERIAL: AL6066-T6 CNC made
DIMENSION: C-C 47-57mm
WEIGHT: 367g/bike



V3L-BRAKE

54-03

Change from coil spring to liner spring balance adjustable.

MATERIAL: AL7075-T6 full CNC made
WEIGHT: 150g/wheel
COLOR: Sand blast anodize



CAMP-94773

55-03

MATERIAL: AL6061-T6 forged
BRAKE SHOES: AMISHA® dark blue
DIMENSION: C-C 47-73mm
COLOR: Sand blast anodize
WEIGHT: 370g/bike



CAMP-97C-R

55-04

Reversed.
MATERIAL: AL6066-T6 CNC made
DIMENSION: C-C 39-51mm (+2mm than normal)
WEIGHT: 310g/bike



JULY-7905-CNC

54-04

MATERIAL: AL6066-T6 CNC made
BRAKE SHOES: CNC cassette
BOLT: Ti-64 main bolt
DIMENSION: C-C 39-51mm
OPTION: SWISS STOP® carbon rim pads available
COLOR: Polish anodize
WEIGHT: 210g/bike
SHIMANO® DURA-ACE 297g/bike
SRAM® RED 240g/bike



JULY-7905-F5

54-05

MATERIAL: AL6061-T6 forged
BRAKE SHOES: forged cassette
BOLT: Cr-Mo main bolt
DIMENSION: C-C 39-51mm
OPTION: AMISHA® carbon rim pads available
COLOR: Polish anodize
WEIGHT: 230g/bike
SHIMANO® DURA-ACE 297g/bike
SRAM® RED 240g/bike

BEST SELLER



CAMP-94773H

55-05

MATERIAL: AL6061-T6 forged CNC made
BRAKE SHOES: AMISHA® dark blue
DIMENSION: C-C 47-73mm
COLOR: Sand blast anodize
WEIGHT: 343g/bike



THRU AXLE

QUICK RELEASE

SEAT CLAMP

TOP CAP

HEADSETS PARTS

CRANK SET

CHAINRING SYSTEM

E-BIKE SYSTEM

ROLLER KIT SERIES

BMX SERIES

CHAINRING PARTS

CHAIN GUIDE SYSTEM

BRAKE SYSTEM

SEATPOST

STEM SYSTEM

HANDLEBAR

AEROBAR SYSTEM

COMPUTER MOUNT

CAGE

ACCESSORIES

FITTING EQUIPMENT

PEDALS

OUTDOOR GEAR

BRAKE SYSTEM



CT-ML-LEVER 56-01

Forged lever & CNC bracket.
Ergonomic lever design.
For Ø31.8mm handlebar.

MATERIAL: AL6061-T6 with Ø24mm shim
WEIGHT: 128g/pair
Not available in Japan
Design by TOKYO SAN-ESU



Multi brake position available



CAS+5 57-01

Angle adjustable brake shoes.

MATERIAL: AL6061-T6 CNC made
SPEC: +5mm for better clear front brake
OPTION: 1. AMISHA® dark blue
2. SWISS STOP® yellow king
3. SWISS STOP® green



CAS-5 57-02

Angle adjustable brake shoes.

MATERIAL: AL6061-T6 CNC made
SPEC: -5mm for better clear rear brake
OPTION: 1. AMISHA® dark blue
2. SWISS STOP® yellow king
3. SWISS STOP® green



V3L-LEVER 56-02

For V-brake.
Three finger.

MATERIAL: AL6066-T6 full CNC made
WEIGHT: 70g/pair
COLOR: Sand blast anodize
BAR: Ø24mm with Ø22.2 Shim

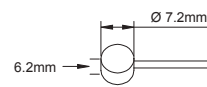

CT32-LEVER 56-03

For canti & caliper brake.
Two finger.

MATERIAL: AL6066-T6 full CNC made
LEVER RANGE: 102mm
WEIGHT: 85g/pair
COLOR: Sand blast anodize
BAR: Ø24mm with Ø22.2 Shim

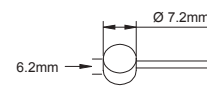

CAS-1 57-03

MATERIAL: AL6061-T6 CNC made
BOLT: Ti-64 SHIMANO® system
WEIGHT: 30g/set
OPTION: 1. AMISHA® dark blue
2. SWISS STOP® yellow king
3. SWISS STOP® green
4. Ti-64 bolt



CAS-62C 57-04

For canti brake.
Angle adjustable brake shoes.

MATERIAL: Forged with CNC made
OPTION: AMISHA® dark blue



CANTI-3C 57-05

With oval pads hold design.
With AMISHA® dark blue brake shoes.

OPTION: SWISS STOP® pads
CNC cas+5 holder for front
CNC cas-5 holder for rear

Non adjustable spring



CANTI-2C 57-06

With AMISHA® dark blue.
Non adjustable spring.



CT3L-LEVER 56-04

For canti & caliper brake.
Three finger.

MATERIAL: AL6066-T6 full CNC made
WEIGHT: 70g/pair
COLOR: Sand blast anodize
BAR: Ø24mm with Ø22.2 Shim

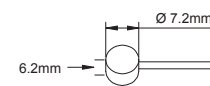

TT-LEVER 56-05

Cold forged lever.
Nylon + Carbon fiber body.

WEIGHT: 95g/pair
COLOR: Sand blast anodize
Aerodynamics design



CANTI-5570A 57-07

Spring adjustable brake system Improve
brake performance.

MATERIAL: AL6061-T6

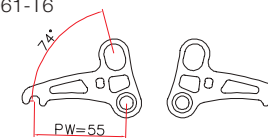

12-CX 57-08

Canti brake hanger for fork.

COLOR: As Order



SEATPOST



The upper and lower clamps, made of carbon fiber, are specifically designed to protect the saddle rail. The contact area between the lower clamp and the rail is enlarged to free the saddle rail from deformation.

SHIM-1012 **BEST SELLER** 59-01

MATERIAL: AL6061-T6
SPEC: OD Ø30.0 x ID Ø27.2 x (H)100mm
 OD Ø30.2 x ID Ø27.2 x (H)100mm
 OD Ø30.6 x ID Ø27.2 x (H)100mm
 OD Ø30.9 x ID Ø27.2 x (H)100mm
 OD Ø31.6 x ID Ø27.2 x (H)100mm
 OD Ø33.9 x ID Ø30.9 x (H)110mm
 OD Ø34.9 x ID Ø30.9 x (H)110mm
 OD Ø33.9 x ID Ø31.6 x (H)110mm
 OD Ø34.9 x ID Ø31.6 x (H)110mm
 OD Ø40.0 x ID Ø33.9 x (H)120mm
COLOR: As Order

SHIM-SLEEVE-NH 59-02

MATERIAL: AL6061-T6
SPEC: As Order
LENGTH: As Order

SPC-SL3 SPC-SL3-DI2 59-03

MATERIAL: One piece UD Carbon fiber
SADDLE CLAMP: Carbon clamp protect Carbon rail
SPEC: Ø27.2 or Ø30.9 or Ø31.6mm
LENGTH: 350 or 400mm
OFFSET: 0mm
WEIGHT: 190g/pcs (Ø31.6x350mm)
OPTION: SPC-SL3-DI2 (with SHIMANO® seatpost battery collar)

SPC-21 SPC-21-DI2 59-04

MATERIAL: UD Carbon fiber
SPEC: Ø27.2 or Ø30.9 or Ø31.6mm
LENGTH: 350 or 400mm
OFFSET: 20mm
WEIGHT: 200g/pcs (Ø31.6x350mm)
OPTION: SPC-21-DI2 (with SHIMANO® seatpost battery collar)

EFBE
 PROFITECHNIK

P1206092 / P1206093
 Pass overload 300 kg

SPA-SL6 / SPA-SL6-DI2 59-05

Full CNC finish.
MATERIAL: AL6066-T6
SPEC: Ø27.2 or Ø30.9 or Ø31.6mm
LENGTH: 350 or 400mm
OFFSET: 0mm
WEIGHT: 309.5g/pcs (Ø31.6x400mm)
OPTION: SPA-SL6-DI2 (with SHIMANO® seatpost battery collar)
 Not available in U.S.A.

SPC-11 / SPC-11-DI2 59-06

MATERIAL: BODY: AL6061-T6
 TUBE: UD Carbon
SADDLE CLAMP: Carbon clamp Protect Carbon rail
SPEC: Ø27.2 or Ø30.9 or Ø31.6mm
LENGTH: 300 or 350 or 400mm
OFFSET: 20mm
WEIGHT: 235g/pcs (Ø31.6x350mm)
OPTION: SPC-11-DI2 (with SHIMANO® seatpost battery collar)

SPA-35A 58-01

MATERIAL: 3D forged AL6061-T6
SPEC: Ø31.8 or Ø34.9mm
LENGTH: 450 or 600 or 700mm
OFFSET: 20mm
WEIGHT: 626g (Ø34.9x450mm)

NEW SPA-SL7 58-02

Aluminum tube with cold drawn process, easy of adjustment and lightweight and stiffness.

MATERIAL: AL7050-T73
SPEC: Ø34x630L
OFFSET: 0mm
WEIGHT: 395g
COLOR: Sand blast anodize

NEW SPA-SF1 58-03

Lightweight Aluminum Tube
MATERIAL: AL6061-T6 PG Tube
SPEC: Ø31.8x610L
THICKNESSES: 2.5T
WEIGHT: 372g
COLOR: Sand blast anodize

ADP-DI2-27.2 ADP-DI2-31.6 59-07

SHIMANO® DI2 seatpost battery collar. With grinding paper, alcohol wipe, glue.

MATERIAL: AL6061-T6
SPEC: ADP-DI2-27.2 for seatpost I.D. Ø22.2mm
 ADP-DI2-31.6 for seatpost I.D. Ø27.2mm
 Seatpost I.D. must be round
 ADP-DI2 O.D. Customer design available
WEIGHT: 16g/pcs (for Ø27.2)
 28.5g/pcs (for Ø31.6)

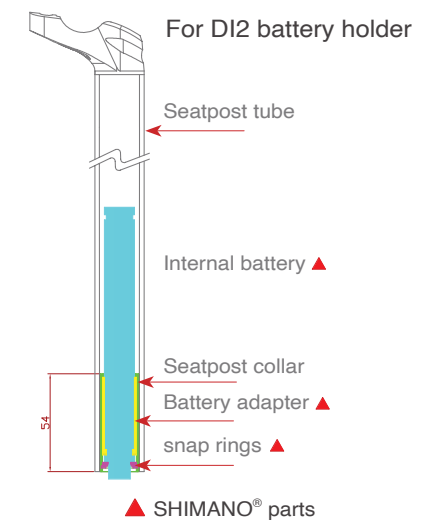

STEM SYSTEM



Better handling and reduced probability of deformation.



STEM-LB35A 60-01

Fork stack height 40mm.
Ø31.8mm handlebar clamp Ø35mm.

MATERIAL: AL6066-T6
SPEC: 80 - 130mm
ANGLE: ±8°
WEIGHT: 142g/pcs (110mm)
OPTION: Titanium bolt
INCLUDING: 1. SHIM-3x2 OD Ø35 x ID Ø31.8 x 60mm
2. SHIM-CC OD Ø31.8 x ID Ø28.6 x 38mm

EFBE
PRÜFTECHNIK

P1306487 / P1306488 / P1306489



SHIM-CC-AL 60-02

Alloy spacer.
MATERIAL: AL6061
SPEC: OD Ø31.8 x ID Ø28.6mm
H: 38mm



SHIM-3X2-AL 60-03

Alloy spacer.
MATERIAL: AL6061
SPEC: OD Ø35 x ID Ø31.8mm
WIDTH: 45mm



SHIM-3x2 60-04

Bar bore adapter also reduces vibrations.
MATERIAL: Carbon
SPEC: OD Ø35 x ID Ø31.8 x 60mm
OD Ø31.8 x ID Ø26 x 60mm
OD Ø31.8 x ID Ø25.4 x 60mm



SHIM-CC 60-05

For fork stem tube.
MATERIAL: Carbon UD
SPEC: OD Ø31.8 x ID Ø28.6mm
H: 38mm



AC-31.8-36-H 60-06

Carbon spacer.
SPEC: OD Ø36 x ID Ø32mm
H: As Order
COLOR: 3K, UD



AC-36-H 60-07

Carbon spacer.
SPEC: OD Ø36 x ID Ø28.6mm
H: As Order
COLOR: 3K, UD



TK-T032A 60-08

For Ø31.8mm fork.
With stainless steel bolt.
MATERIAL: AL6061-T6
WEIGHT: 11.2g/pcs



TK-032SW 60-09

For carbon Ø31.8mm fork.
SPEC: Ø27.5 - Ø27.7mm with shim
LENGTH: 45mm
WEIGHT: 44g/pcs



STAR NUT-29 60-10

For Ø31.8mm alloy / Cr-Mo fork.
SPEC: Ø28.8mm

WE CAN REACH YOUR IDEAL DESIGN
BASED ON OUR STEM EXTRUSION MATERIAL DATA.

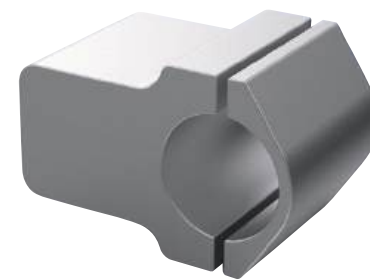

Your Design



WE MAKE STEM(CNC)



► Case Example



SM-1396_Project 61-01

MATERIAL: AL6061-T6
LENGTH: C-C : 35m/m
SPEC: Steerer tube Ø28.6
Bar Bore Ø31.8

► Case Example



SM-1404_Project 61-02

MATERIAL: AL6061-T6
LENGTH: C-C : 50m/m
SPEC: Steerer tube Ø28.6
Bar Bore Ø31.8

STEM SYSTEM



STEM-IGM

62-01

Full CNC made stem integrated cycling computer mount.

MATERIAL: AL6061-T6
SPECS: Handlebar clamp Ø31.8mm
 Steerer tube Ø28.6mm
LENGTH: 80 - 120mm
ANGLE: -6° / -17° / -25°
WEIGHT: 186g/pcs (100mm)



STEM-LB017

62-02

Fork stack height 40mm Ø31.8mm.
 Handlebar clamp Ø31.8mm.

MATERIAL: AL6066-T6
SPECS: Diameter Handlebar Ø35mm
 Steerer Tube Ø31.8mm
 Fork Stack Height 40mm
LENGTH: 80 - 120mm
ANGLE: ±17°
WEIGHT: 154g/pcs (140mm)
OPTION: Titanium bolt



STEM-MA611

BEST SELLER

62-03

Classic shape design.

MATERIAL: AL6061-T6 3D forged
SPECS: Bar-bore Ø31.8mm
 Steerer tube Ø28.6mm
 Fork stack height 40mm
ANGLE: ±6°
LENGTH: 70 - 120mm
WEIGHT: 150g/pcs (100mm)



STEM-MA-618-35

BEST SELLER

62-04

Classic shape design.

MATERIAL: AL6061-T6 3D forged
SPECS: Bar-bore Ø35mm
 Steerer tube Ø31.8mm
 Fork stack height 40mm
ANGLE: ±6°
LENGTH: 70 - 120mm
WEIGHT: 145g/pcs (90mm)



STEM-LB1

62-05

MATERIAL: AL6066-T6
SPECS: Diameter handlebar Ø31.8mm
 Steerer Tube Ø28.6mm
 Fork Stack Height 40mm
LENGTH: 50 - 140mm
ANGLE: ±6°
WEIGHT: 128g/pcs (120mm)
OPTION: Titanium bolt



STEM-32-ST

62-06

MATERIAL: AL6061-T6
SPECS: Handlebar clamp Ø31.8mm
 Steerer tube Ø28.6mm
ANGLE: 0°
LENGTH: 35mm
WEIGHT: 103g/pcs
W/O: Top cap



SM-DH35

62-07

MATERIAL: AL6066-T6
DIRECT MOUNT: Boxer
SPEC: Handlebar clamp Ø35mm
 Offset height 25mm
WEIGHT: 170g/pcs
OPTION: SHIM-3x2 (Ø35 x Ø31.8mm)

HANDLEBAR

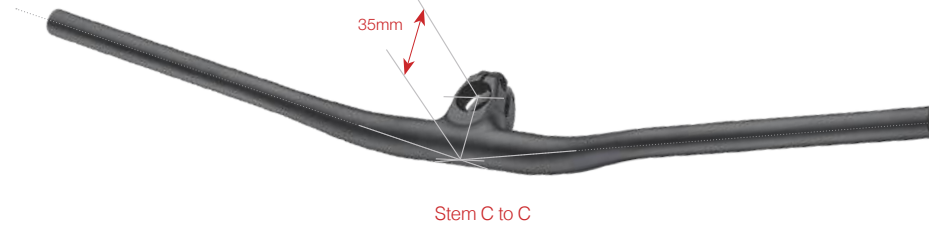

NEW **PATENTED**
HB-STB-M35-MR02

63-01

MATERIAL: AL-6061-T6
SPEC: Stem length 35mm
 Bar width 800mm
 For Ø28.6 Steer tube
RISE: 30mm
BACK SWEEP: 8 degree
UP SWEEP: 5 degree

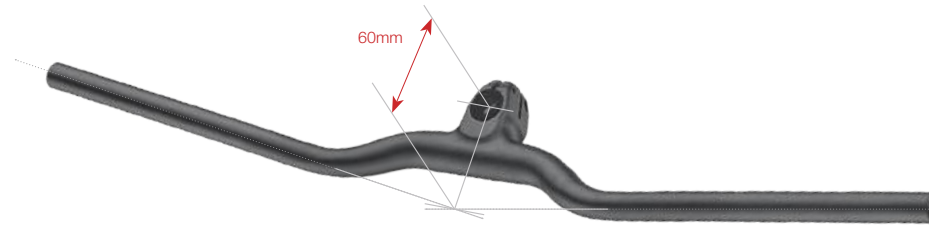

NEW **PATENTED**
HB-STB-M35-MR060

63-02

MATERIAL: AL-6061-T6
SPEC: Stem length 60mm,
 Bar width 800mm, For Ø28.6 Steer tube
BACK SWEEP: 8 degree
UP SWEEP: 5 degree

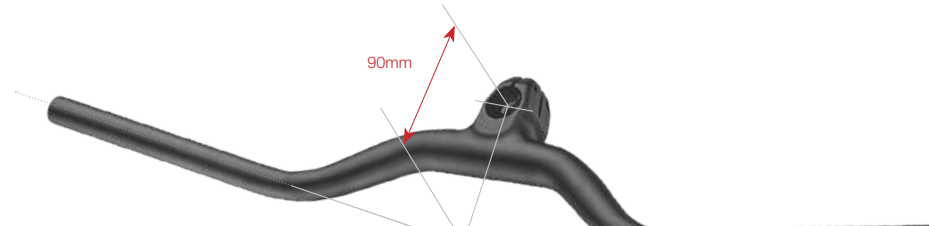

NEW **PATENTED**
HB-STB-M35-MR090

63-03

MATERIAL: AL-6061-T6
SPEC: Stem length 90mm
 Bar width 800mm, For Ø28.6 Steer tube
BACK SWEEP: 8 degree
UP SWEEP: 5 degree



HB-MBR-780/32
HB-MBR-780/32-H (600kg)

63-04

MATERIAL: Carbon fiber (3K or UD)
SPEC: Ø31.8 x W780mm
RISE: 20mm
BACK SWEEP: 9 degree
UP SWEEP: 5 degree
WEIGHT: 280g/pcs±10g
OPTION: HB-MBR-780 / 32-H
WEIGHT: 320g/pcs±10g
OVERLOAD: 600kg for DH use

EFBE
 PRUFTECHNIK
 P1306490 / P1306491 /
 P1306492



HB-MBR-780/35
HB-MBR-780/35-H (600kg)

63-05

MATERIAL: Carbon fiber (3K or UD)
SPEC: Ø35 x W780mm
RISE: 20 / 30mm
BACK SWEEP: 9 degree
UP SWEEP: 5 degree
WEIGHT: 285g/pcs±10g
OPTION: HB-MBR-780 / 35-H
WEIGHT: 325g/pcs±10g
OVERLOAD: 600kg for DH use

EFBE
 PRUFTECHNIK
 P1306487 / P1306488 /
 P1306489



THRU AXLE

QUICK RELEASE

SEAT CLAMP

TOP CAP

HEADSETS PARTS

CRANK SET

CHAINRING SYSTEM

E-BIKE SYSTEM

ROLLER KIT SERIES

BMX SERIES

CHAINRING PARTS

CHAIN GUIDE SYSTEM

BRAKE SYSTEM

SEATPOST

STEM SYSTEM

HANDLEBAR

AEROBAR SYSTEM

COMPUTER MOUNT

CAGE

ACCESSORIES

FITTING EQUIPMENT

PEDALS

OUTDOOR GEAR



P1306490 / P1306491 / P1306492

Specifications are subject to change without notice.

HANDLEBAR

NEW

HB-STB-M1

64-01



MATERIAL: AL6061-T6
STEM ANGLE: 10°
STEM LENGTH: 70 / 90 / 110mm
WIDTH (HOOD TO HOOD)/WIDTH(DROP TO DROP):
 about 380 / 413 ; 400 / 433 ; 420 / 453 ;
 440 / 473 ; 460 / 493 (mm)
STEERER TUBE: Ø28.6mm
FORK STACK HEIGHT: 40mm
FLARE: 12°
DROP: 120mm
REACH: 85mm
WEIGHT: about 530g (W: 400mm; Stem L: 90mm)
HEADSET COMPATIBLE WITH TOKEN® A-BOX
CODE: TK155P

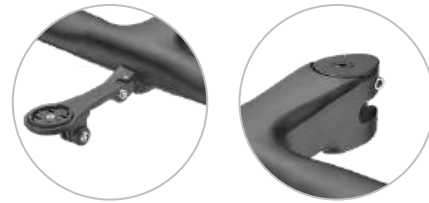

Integrated extension mount and top cap.

DESIGN FOR DI2 CABLE HOLE

The inner cable of Di2 is getting popular, so MR Control make change for all types of road bike handlebar, we drill the hole for Di2 inner cable to make the handlebar look more clean.



HB-RBC1-1

65-01

MATERIAL: Carbon fiber
SPEC: Ø31.8 x W400mm / 420mm / 440mm (C-C)
DROP: 130mm
REACH: 80mm
BAR TYPE: Compact bend
WEIGHT: 216g/pcs±10g

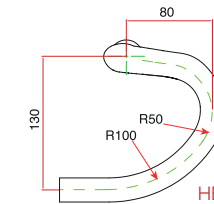

HB-RBC1-1 Compact bend



HB-RBA-0209

64-02

MATERIAL: AL6061-T6
SPEC: Ø31.8 x W360mm / 380mm / 400mm / 420mm /
 440mm (C-C)
INWARD: 10degrees
FLARE: 10degrees
DROP: 115mm
REACH: 75mm
BAR TYPE: Compact bend
WEIGHT: 297g/pcs±10g

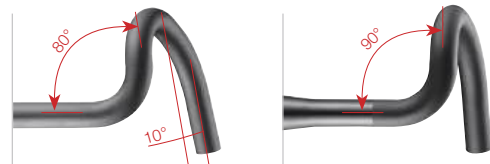

Innovation version
HB-RBA-0209

Current type



HB-RBA11

65-02

Rise 15mm, could provide different riding posture for rider.

MATERIAL: AL6061-T6
SPEC: Ø31.8 x W360mm / 380mm / 400mm / 420mm (C-C)
DROP: 125mm
REACH: 80mm
BAR TYPE: Anatomic bend
WEIGHT: 310g/pcs±10g

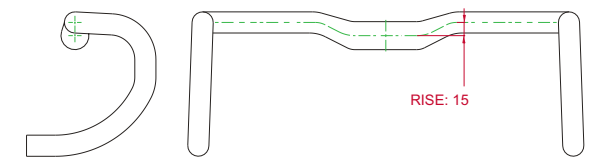

RISE: 15



HB-RBC1

64-03

MATERIAL: Carbon fiber
SPEC: Ø31.8 x W400mm / 420mm / 440mm (C-C)
DROP: 130mm
REACH: 80mm
BAR TYPE: Anatomic bend
WEIGHT: 216g/pcs±10g

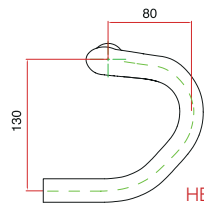

HB-RBC1 Anatomic bend



HB-RBA12

65-03

Provides a reduced-size version for the female market.

MATERIAL: AL6061-T6
SPEC: Ø31.8 x 380mm / 400mm / 420mm (C-C)
DROP: 125mm
REACH: 75mm
BAR TYPE: Compact bend
WEIGHT: 310g/pcs±10g

EFBE
 PRÜFTECHNIK

P1206089 / P1206090
 P1206091



THRU AXLE

QUICK
RELEASE

SEAT CLAMP

TOP CAP

HEADSETS
PARTS

CRANK SET

CHAINRING
SYSTEM

E-BIKE SYSTEM

ROLLER KIT
SERIES

BMX SERIES

CHAINRING
PARTS

CHAIN GUIDE
SYSTEM

BRAKE SYSTEM

SEATPOST

STEM SYSTEM

HANDLEBAR

AEROBAR
SYSTEM

COMPUTER
MOUNT

CAGE

ACCESSORIES

FITTING
EQUIPMENT

PEDALS

OUTDOOR GEAR

AEROBAR SYSTEM



Include adapter 20 / 40 / 60mm

TRI-ORG-12H

66-01

Armrest with adapter for height adjustment.

MATERIAL: AL6061-T6 CNC made
SPEC: For Ø31.8mm handlebar with TUB-S
OPTION: ALLOY EXTENSION TUBE:
 TUB-S, TUB-J, TUB-S1, TUB-S2
3K OR UD CARBON EXTENSION TUBE:
 TUB-S-C, TUB-J-C, TUB-I-C, TUB-S2-C



67-01

TRI-BR120P

For triathlon extension bars bridge.
 With Ø26mm computer tube.

WIDTH: min.85mm-max.105mm,
 5mm pitch adjustable width
 Maximum 20mm
MATERIAL: Nylon
WEIGHT: 54g/set



67-02

WB-TT1

Clamping the water bottle cage for triathlon bar.
 Bundle for easy hold.

MATERIAL: AL6061-T6
WEIGHT: 30g/set



66-02

TRI-ORG-12F

Classic design armrest.

MATERIAL: AL6061-T6 forged CNC made
SPEC: For Ø31.8mm handlebar with TUB-S
OPTION: ALLOY EXTENSION TUBE:
 TUB-S, TUB-J, TUB-S1, TUB-S2
3K OR UD CARBON EXTENSION TUBE:
 TUB-S-C, TUB-J-C, TUB-I-C, TUB-S2-C



66-03

TRI-MINIBAR

P.A.T ED
 For MTB and Road

SPEC: 44mm rise up
 From handle position
 For Ø31.8mm handlebar

TUB-J

67-03

MATERIAL: AL6061-T6
ANGLE: 50 degree
LENGTH: 300mm
WEIGHT: 190g/pair

TUB-J



TUB-S2

67-04

MATERIAL: AL6061-T6
ANGLE: 17 degree
LENGTH: 310mm
WEIGHT: 147g/pair

TUB-S2



TUB-S

67-05

MATERIAL: AL6061-T6
ANGLE: 17 degree
LENGTH: 340mm
WEIGHT: 203.5g/pair

TUB-S



TUB-S1

67-06

MATERIAL: AL6061-T6
ANGLE: 17 degree
LENGTH: 180mm
WEIGHT: 117g/pair

TUB-S1



66-04

TRI-PA1.75

P.A.T ED
 Armrest adjustable main bar.
 1.75 rise up from handle.

MATERIAL: AL6061-T6
SPEC: For Ø31.8mm handlebar
 position with TUB-S
OPTION: ALLOY EXTENSION TUBE:
 TUB-S, TUB-J, TUB-S1, TUB-S2
3K OR UD CARBON EXTENSION TUBE:
 TUB-S-C, TUB-J-C, TUB-I-C, TUB-S2-C

TUB-J-C

67-07

MATERIAL: Carbon fiber
 Ø22.2 rest bar
ANGLE: 50 degree
LENGTH: 300mm
WEIGHT: 131g/pair
 Finish Carbon 3K or Carbon UD

TUB-J-C



TUB-S2-C

67-08

MATERIAL: Carbon fiber
 Ø22.2 rest bar
LENGTH: 310mm
ANGLE: 17 degree
WEIGHT: 120g/pair
 Finish Carbon 3K or Carbon UD

TUB-S2-C



TUB-S-C

67-09

MATERIAL: Carbon fiber
 Ø22.2 rest bar
ANGLE: 17 degree
LENGTH: 340mm
WEIGHT: 140g/pair
 Finish Carbon 3K or Carbon UD

TUB-S-C



TUB-I-C

67-10

MATERIAL: Carbon fiber
 Ø22.2 rest bar
ANGLE: 0 degree
LENGTH: 300mm
WEIGHT: 132g/pair
 Finish Carbon 3K or Carbon UD

TUB-I-C



COMPUTER MOUNT



AVAILABLE IN DIFFERENT CYCLING COMPUTER AND CAMERA / LIGHT MOUNT

Interchangeable trays:



Bracket fatigue test method: Impact 150kg/f at the stem/handle-bar. load of 1,000 grams at the extension arm and run for 100,000 times.

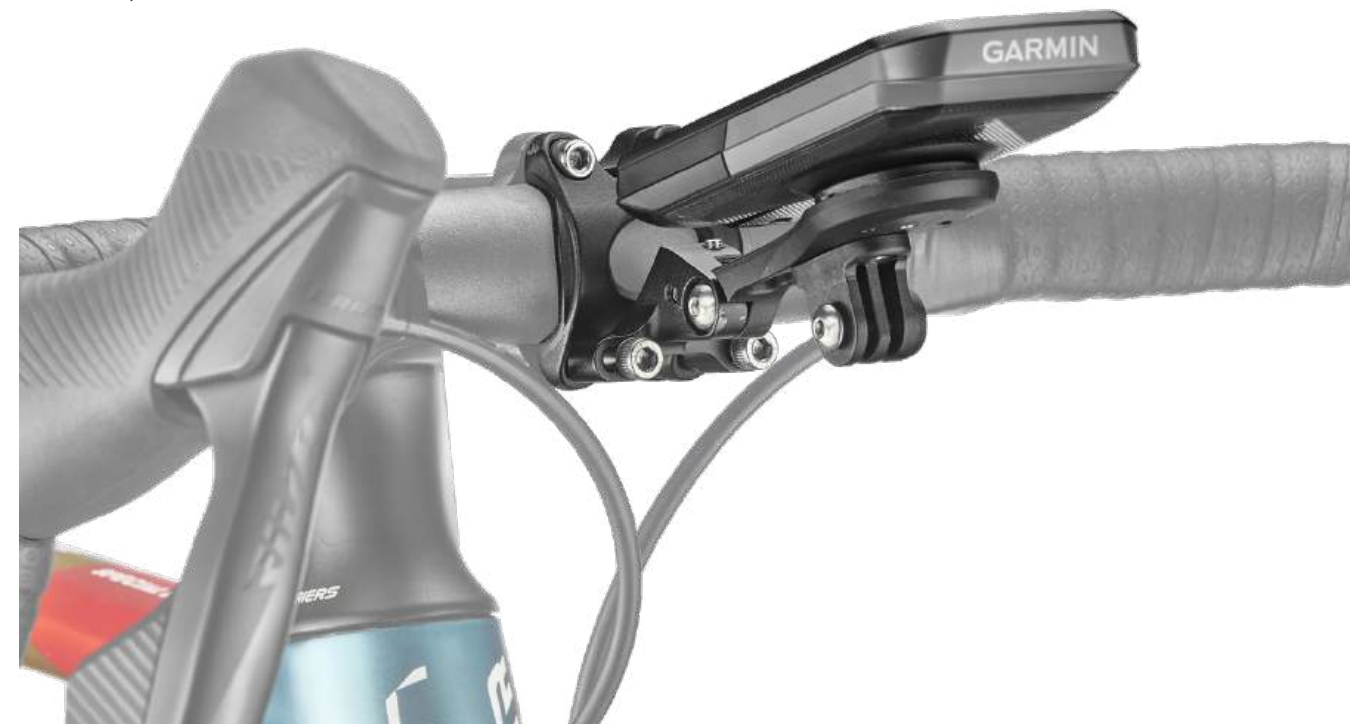

COMPUTER MOUNT



Angle adjust serew.



Secondary fixing screw.

P.A.T.
Taiwan No.113206040 / 113206042
China No.202421339745.6 / 202421339739.0



NEW GM-GRA

70-01

Computer mount for integrated bar stem.
Main arm angle adjustable.

MATERIAL: AL 6061-T6
Extension arm / PA66
FEATURES: Extension arm angle adjustable.
Dual fixing bolt system.
Interchangeable tray system.



NEW GM-GR-CX2

70-02

CNC bracket available in interchangeable trays.
Fit stem screw distance : 25mm- 34mm

MATERIAL: Base / AL6061-T6
Extension arm / PA66
FEATURES: Extension arm angle adjustable.
Dual fixing bolt system.
Interchangeable tray system.

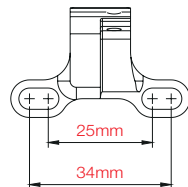

Fit stem screw distance



NEW GR-MOUNT-SL-R

70-03

Best computer mount solution when use areo handlebar with barbore Ø31.8 stem.
Cap fit Giant CONTACT SL AERO STEM and CONTACT SLR AERO STEM.

MATERIAL: Cap / AL-6061-T6
Extension arm / PA66
FEATURES: Extension arm angle adjustable.
Dual fixing bolt system.
Interchangeable tray system.

Stem cap customsize available.



NEW GR-MOUNT-AEROLIGHT

70-04

Best computer mount solution when use areo handlebar with barbore Ø31.8 stem.
Cap fit Giant CONTACT AEROLIGHT STEM.

MATERIAL: Cap / AL-6061-T6
Extension arm / PA66
FEATURES: Extension arm angle adjustable.
Dual fixing bolt system.
Interchangeable tray system.

Stem cap customsize available.



GMX-MY23

71-01

Computer mount for integrated bar stem.
Main arm angle adjustable.

MATERIAL: AL6061
WEIGHT: 46g/set
Not available in Japan



AC-MTB35

71-02

Clamping type for MTB and cyclocross cycling
computer mount.
Place cycling computer above the stem.

MATERIAL: AL6061
SPEC: Clamp Ø35mm with SHIM Ø31.8mm
WEIGHT: 39g/set

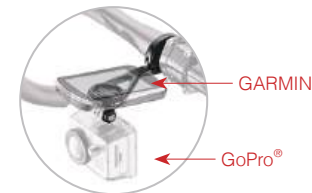

ADP-BCM-P

71-03

For handlebar cycling computer mount.
With removable GoPro® interface.
Simple and fast installation.
CNC bracket, available in interchangeable trays.

MATERIAL: AL6061-T6
SPEC: Clamp Ø31.8mm
WEIGHT: 57g/set

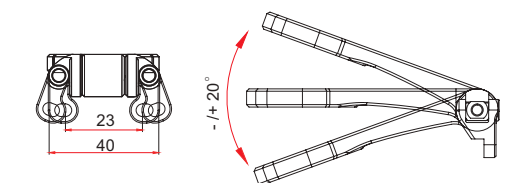

ADP-RSCAP

71-04

P.A.T ED
OPTION: With GoPro® mount (-GO).
CNC bracket, available in interchangeable trays.

SCREW CENTER DISTANCE: 23 - 40mm
ANGLE ADJUSTABLE: 20°
WEIGHT: ADP-RSCAP: 33.5g/set (without adapter)
ADP-RSCAP-GO: 42g/set (without adapter)

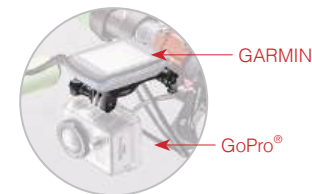
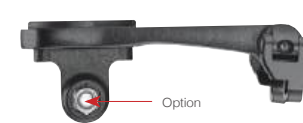

COMPUTER MOUNT

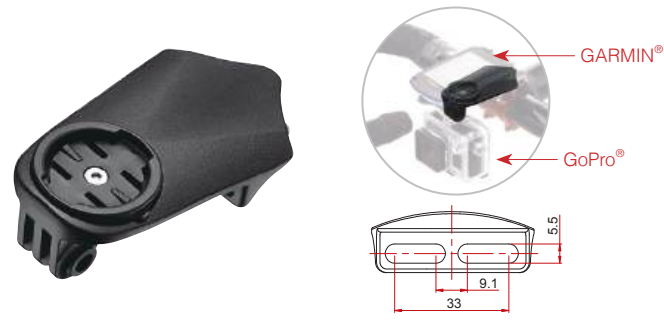

ADP-COMPGR 72-01

Computer mount of stem cap.
CNC bracket, available in interchangeable trays.

MATERIAL: AL6061-T6
SCREW CENTER DISTANCE: 13.5-34.5mm
WEIGHT: 40g/set (with out adapter)



AR-GM1 72-02

Steerer tube type cycling computer mount.
CNC bracket, available in interchangeable trays.

SPEC: For Ø28.6mm steerer tube
Thickness 7mm
LENGTH (Centre-to-Centre): 60mm
ANGEL: -6 degree



ADP-GM1-TT 72-03

For Triathlon armrest Ø22.2mm tube.
CNC bracket, available in interchangeable trays.

MATERIAL: AL6061-T6 body
Plastic adapter
WEIGHT: 42.5g/set (without adapter)



TK-GM1-DX 72-04

Top cap cycling computer mount.
CNC bracket, available in interchangeable trays.

MATERIAL: AL6061-T6



GM-GO (GoPro®) 72-05

Compatible with GARMIN Edge® interface, for GoPro® mount.

MATERIAL: Plastic



ADP-INT-GM1 72-06

Computer mount for integrated bar stem.

MATERIAL: AL6061-T6
OPTION: GPO7 mount compatible

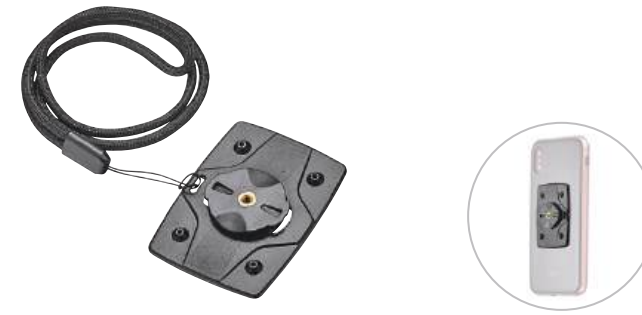

GM1-BASE 73-01

Compatible with GARMIN Edge® cycling computer interface.

Use 3M tape and safety bolts to fit device cover.

MATERIAL: Polycarbonate (PC)
Recommend for indoor bike trainers use.



ADP-SD-GP01 73-02

Standard saddle rail mount for GoPro® camera.

MATERIAL: AL6061-T6
WEIGHT: 38g/set



ADP-GMSP1 73-03

Compatible for GoPro® for Ø31.6 seatpost.
With Ø27.2 shim.

MATERIAL: AL6061-T6 body
WEIGHT: 59.5g/set (without adapter)



AR-286-EXT-P 73-04

GoPro® interface extension arm.

MATERIAL: Plastic
HIGH: 8mm
EXTENSION ARM LENGTH: 50mm



ADP-GPL 73-05

GoPro® mount convert to light holder.

MATERIAL: AL6061-T6



THRU AXLE

QUICK RELEASE

SEAT CLAMP

TOP CAP

HEADSETS PARTS

CRANK SET

CHAINRING SYSTEM

E-BIKE SYSTEM

ROLLER KIT SERIES

BMX SERIES

CHAINRING PARTS

CHAIN GUIDE SYSTEM

BRAKE SYSTEM

SEATPOST

STEM SYSTEM

HANDLEBAR

AEROBAR SYSTEM

COMPUTER MOUNT

CAGE

ACCESSORIES

FITTING EQUIPMENT

PEDALS

OUTDOOR GEAR

COMPUTER MOUNT



AR-286-GP1

74-01

GoPro® mount convert to light holder.

MATERIAL: Plastic
HIGH: 8mm
COLOR: As Order
C-C: 70mm



ADP-WM318

74-02

Sport watch mount for handlebar.

MATERIAL: AL6061-T6
For Ø31.8mm handlebar clamp
WEIGHT: 82g/set

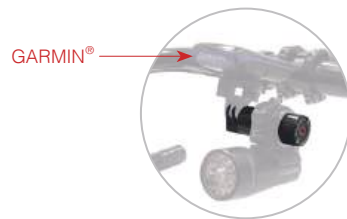

ADP-GP25-12

74-03

GoPro® mount convert extension arm.

MATERIAL: AL6061-T6
Carbon tube
OPTION: Alloy tube (ADP-GP25-12E)



ADP-GP25-02E

74-04

GoPro® mount screw with extension arm.

MATERIAL: AL6061-T6

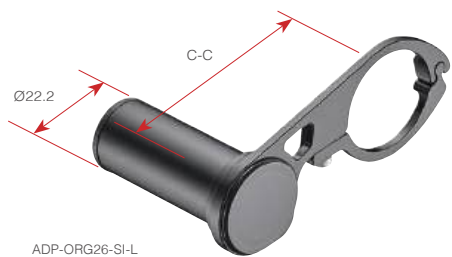

ADP-ORG26-SI-L ADP-ORG26-R

74-05

Single clamp type with alloy extension bar.
Easy assembly shift on gravel bike.

SPEC: Ø31.8 x Ø22.2mm Extension bar
C-C: 52mm
COLOR: As Order

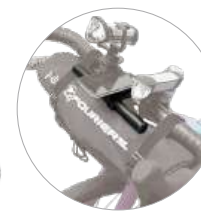
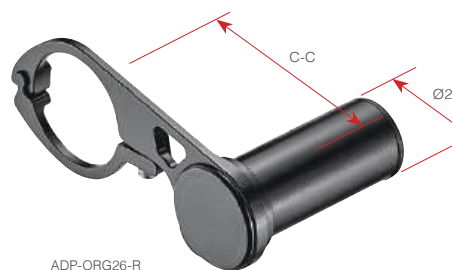

ADP-3R

75-02

Alloy clamp & tube.

WITH SHIM: R051 (Ø31.8 x Ø25.4mm x 11w)
R056 (Ø31.8 x Ø26mm x 11w)
SPEC: Ø31.8 x Ø22.2mm



ADP-3RL

75-04

Double alloy clamp with length 200mm tube.
Adjustable clamp spacing.

MATERIAL: AL6061-T6
SPEC: Ø31.8mm
TUBE: Ø22.2 x 200L
WEIGHT: 43g/ set
COLOR: As Order

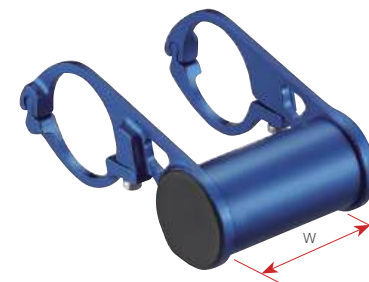

ADP-ORG26-A

75-06

Create extra space for handlebar.
Double clamp with AL6061-T6 tube Ø26mm.

MATERIAL: AL6061-T6
SPEC: Ø31.8mm
W: 46mm / 59mm
WEIGHT: 43g/set (46mm)
COLOR: As Order



ADP-3RC

75-03

Alloy clamp + Carbon tube.

WITH SHIM: R051 (Ø31.8 x Ø25.4mm x 11w)
R056 (Ø31.8 x Ø26mm x 11w)
SPEC: Ø31.8 x Ø22.2mm



ADP-ORG26

75-05

Create extra space for handlebar.
Double clamp with Carbon tube Ø26mm.

MATERIAL: AL6061-T6
SPEC: Ø31.8mm
W: 46mm / 59mm
WEIGHT: 32g/set (46mm)

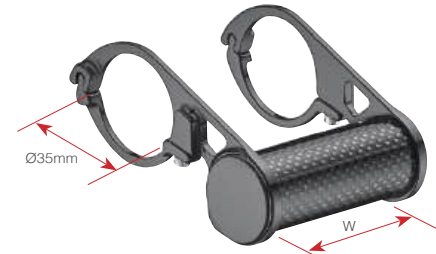

ADP-ORG26-35 ADP-ORG26-35-A

75-07

Create extra space for handlebar.
Double clamp with tube Ø26mm.

MATERIAL: AL6061-T6 clamp
ADP-ORG26-35: 3K CARBON tube
ADP-ORG26-35-A: AL6061-T6 tube
SPEC: Ø35mm
W: 46mm / 59mm



NEW ADP-3RL-2X32

75-01

Double clamp for Ø31.8 extension bar,
create extra space for bike packing gear.

MATERIAL: AL6061-T6
SPEC: Clamp Ø31.8 mm
TUBE: Ø31.8 x 200L

COMPUTER MOUNT



ADP-KIOX-GR-32 / 35 77-01

Clamp type computer mount for KIOX on-board computer.

MATERIAL: Nylon
SPEC: For Ø31.8mm / Ø35mm handlebar



ADP-KIOX-GRBAR-32 / 35 77-02

Clamp type computer mount for KIOX on-board computer.

MATERIAL: Nylon
SPEC: For Ø31.8mm / Ø35mm handlebar



ADP-KIOX-TOP 77-03

Top cap type computer mount. For Kiox.

MATERIAL: Nylon
SPEC: For Ø28.6mm steerer tube



ADP-KIOX-GR-MB-32 / 35 77-04

Clamp type computer mount for KIOX on-board computer.

MATERIAL: Nylon
SPEC: For KIOX mount



ADP-KIOX-BWP 77-05

Clamp type computer mount for Kiox on-board computer. For MTB bike.

MATERIAL: Nylon
SPEC: For Ø31.8mm handlebar clamp



ADP-KIOX-FP 77-06

Clamp type computer mount for Kiox on-board computer. For Road bike / City bike.

MATERIAL: Nylon
SPEC: For Ø31.8mm handlebar clamp



ADP-KIOX-FBE-32 / 35 76-01

For new generation KIOX bracket. Install KIOX display in front of the stem position.

MATERIAL: Nylon
SPEC: For Ø31.8mm / Ø35mm handlebar



ADP-KIOX-FBE-BAR-32 / 35 76-02

For new generation KIOX bracket include extension bar for control unit.

MATERIAL: Nylon
SPEC: For Ø31.8mm / Ø35mm handlebar



ADP-KIOX-MBE-32 / 35 76-03

For new generation KIOX bracket. Install KIOX display rear and left of the handlebar position.

MATERIAL: Nylon
SPEC: For Ø31.8mm / Ø35mm handlebar



THRU AXLE

QUICK RELEASE

SEAT CLAMP

TOP CAP

HEADSETS PARTS

CRANK SET

CHAINING SYSTEM

E-BIKE SYSTEM

ROLLER KIT SERIES

BMX SERIES

CHAINING PARTS

CHAIN GUIDE SYSTEM

BRAKE SYSTEM

SEATPOST

STEM SYSTEM

HANDLEBAR

AEROBAR SYSTEM

COMPUTER MOUNT

CAGE

ACCESSORIES

FITTING EQUIPMENT

PEDALS

OUTDOOR GEAR

77



WB-R1-20C
WB-R1-20C-L NEW

78-01

Unique geometric design of the bottle cage keeps the bottle securely in place during aggressive riding situations.

SPEC:
WB-R1-20 for right side to access water bottle.
WB-R1-20-L for left side to access water bottle.
MATERIAL: Carbon composite
WEIGHT: 32g/pcs



WB-R1-17C

78-02

Carbon long fiber with nylon injection.

MATERIAL: Carbon composite
WEIGHT: 30g/pcs



Allow two pieces to be used in combination. The design adds the advantage of adjustable position.

WB-UHD-22

79-01

Simply way to carry a Ø20mm tube. Installed under the bottle cage.

MATERIAL: Nylon
WEIGHT: 13g/pcs



WB-EXB1

79-02

CO2 extension mount for water bottle cage.

MATERIAL: AL6061-T6



ADP-SPWB1

79-03

Water bottle cage adapter for seatpost.

MATERIAL: AL6061-T6
SPEC: Ø31.6mm
With shim for Ø31.6mm change to Ø27.2mm



NEW
WB-STP52

79-04

Excellent solution for extra parts storage.

MATERIAL: Bracket/ AL6061-T6
Strap/ Plastic+ Velcro
SPEC: Strap 25 x 250mm



NEW
AR-STP34

79-05

Extra storage spacer in stem area.

MATERIAL: Spacer/ AL6061-T6
Strap/ Plastic+ Velcro
SPEC: Spacer/ H 4mm, ID Ø28.6mm
Strap/ 25 x 250mm



NEW
WB-EXT-M

79-06

Bottle cage adapter. Used to change the position of the water bottle cage. Adjustable range 46mm.

MATERIAL: AL6061-T6

ACCESSORIES



PU-8705-TP02 80-01

For Road Bike (700C).

Besides tires and tubes, rim Tape is the third most important factor for puncture protection. The rim tape effectively protects the tube.
SPEC: (W) 20 x (L) 2090mm

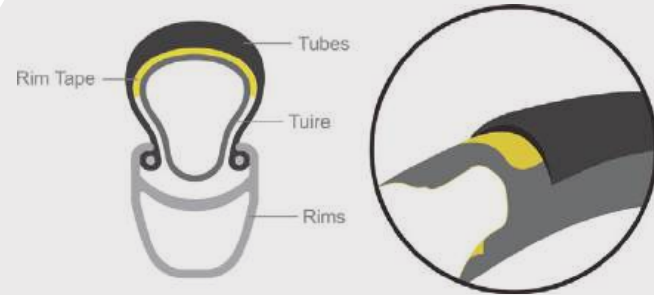

PU-8705-TM01-26
PU-8705-TM01-29 80-02

For MTB.

Besides tires and tubes, rim Tape is the third most important factor for puncture protection. The rim tape effectively protects the tube against mechanical damage.
SPEC: (W) 31 x (L) 2100mm (TM01-26)
(W) 31 x (L) 2350mm (TM01-29)



PU-8703T2-100-1500 80-03

High modulus PU
High puncture
High string through resistance
SPEC: (W) 100 x (L) 1500mm



PU-8703-T2 80-04

High modulus PU
High wear resistance
High puncture resistance
SPEC: (W) 31 x (L) 230mm x 2pcs



TL-BB-EXT56
TL-BB-EXT50
TL-BB-EXT48
TL-BB-EXT43 81-01

The **BOTTOM BRACKET TOOL** is made by high precision CNC machine to provide better contact area and stability of operation. It can suitable for different specifications of BB and prevent tool slippage during use.

MATERIAL: AL7075
WEIGHT: EXT56 109g / EXT50 91g / EXT48 82g / EXT43 66g
COLOR: EXT56 Silver / EXT50 Gold / EXT48 Green / EXT43 Gray

TL-BB-AXLE 2224
TL-BB-AXLE 2829
TL-BB-AXLE 2830 81-02

Suitable for different specifications of BB and prevent tool slippage during use.

MATERIAL: AL6061
WEIGHT: AXLE2224 59g / AXLE2829 117g / AXLE2830 125g
COLOR: AXLE2224 Blue / AXLE2829 Black / AXLE2830 Red



PU-8703-T12 80-05

High modulus PU
High wear resistance
High puncture resistance
SPEC: 1. (W) 88 x (L) 92mm
2. Ø30 x 30mm x 5pcs
3. Ø50 x 20mm x 5pcs
4. (W) 31 x (L) 230 mm x 1 pcs

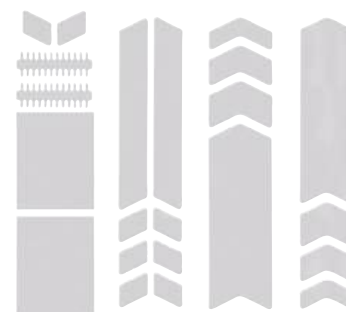

PU-8703-T22 80-06

The function of protector is to provide the best Friction resistance and protection for the frame, it keeps your frame new and clean.

MATERIAL: PVC
SPEC: Top tube protection x1
Down tube protection x1
Chainstay protection x2
Frame or other protection x6
COLOR: 50% Transparent
WEIGHT: 31g



NEW
PU-9000-T22 80-07

The function of protector is to provide the best Friction resistance and protection for the frame, it keeps your frame new and clean.

MATERIAL: PU
SPEC: Top tube protection x1
Down tube protection x1
Chainstay protection x2
Frame or other protection x6
H: 0.25mm
COLOR: Transparent
WEIGHT: 29g



TL-BB-SET 81-03

Both sides of the tool are available to BB of different sizes, and the different colors make it easy to distinguish the sizes.

MATERIAL: AL7075 / AL6061
SPEC: Bottom bracket tool & Axle



ACCESSORIES



M-FX-F / M-FX-R 82-01

For fixed gear axle.
MATERIAL: AL7075-T651
SPEC: M9 x 1.0, M10 x 1.0
LENGTH: 14mm, 18mm



M-FXS 82-02

For fixed gear axle.
MATERIAL: Steel heat treated
SPEC: M9 x 1.0, M10 x 1.0
LENGTH: 14.6mm
OPTION: Surface ED finished



ADP-HUB-1509
ADP-HUB-1209 82-03

MATERIAL: Cr-Mo heat treated
ADP-HUB-1509:
 Adapter for Ø15mm hub axle change to Ø5mm axle
ADP-HUB-1209:
 Adapter for Ø12mm hub axle change to Ø5mm axle



SHIM-R051
SHIM-R056 82-04

With flange.
SPEC: R051 (Ø31.8 x Ø25.4mm)
 R056 (Ø31.8 x Ø26mm)
H: 50mm or As Order



SHIM-11 / SHIM-21 82-05

Custom request available.
SPEC: SM11 (Ø31.8 x Ø25.4mm)
 SM21 (Ø28.6 x Ø25.4mm)
H: 50mm



SHIM-21S 82-06

Custom request available.
SPEC: Ø28.6 x Ø25.4mm
H: 40mm



TIP-4 / TIP-5 82-07

Rubber cover helps prevent dust and water.
MATERIAL: TPR
SPEC: 4mm, 5mm
COLOR: Black



1257A 82-08

Front cable hanger.
SPEC: With tube Ø25.4, Ø28.6
COLOR: Black & Silver

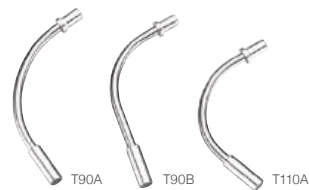

T90A / T90B / T110A 82-09

Stainless tube for V-brake.



1244A 82-10

MATERIAL: AL6061-T6



1270-F / 1270-F-B / 1270-F-A 83-01

Cable hanger (bend tube) with adjustable screw. / Cold forged.
SPEC: Ø28.6mm Front
LONG-LEG: 34mm
COLOR: Black, Silver

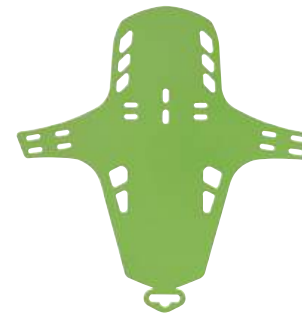

MG-PF15 83-02

Durable, all-weather polypropylene material Smart-Fix construction for quick removal. For front fork.

MATERIAL: Polypropylene (PP)
THICKNESS: 0.8mm
COLOR: Black, Apple Green, Orange, Red, White, Yellow
 If need zip tape will upcharge

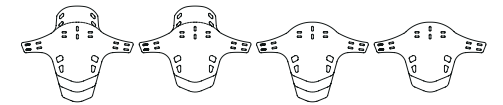

➤ Cut it by yourself

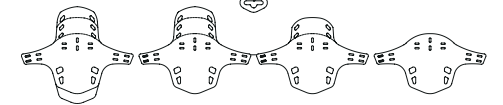
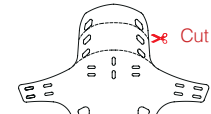

MG-PR17 83-03

Durable, all-weather polypropylene material Smart-Fix construction for quick removal. For front fork.

MATERIAL: Polypropylene (PP)
THICKNESS: 1.2mm
COLOR: Black



MG-PF27 83-04

Durable, all-weather polypropylene material Smart-Fix construction for quick removal. For saddle rail.

MATERIAL: Polypropylene (PP)
THICKNESS: 1.2mm
COLOR: Black



MG-PR02 83-05

Durable, all-weather polypropylene material Smart-Fix construction for quick removal. For front fork.

MATERIAL: Polypropylene (PP)
THICKNESS: 0.8mm
COLOR: Black, Apple Green, Orange, Red, White, Yellow



MG-PF12 83-06

Durable, all-weather polypropylene material Smart-Fix construction for quick removal. For saddle rail.

MATERIAL: Polypropylene (PP)
THICKNESS: 0.8mm
COLOR: Black, Apple Green, Orange, Red, White, Yellow



NOT AVAILABLE IN EURO

NOT AVAILABLE IN U.S.A.

ACCESSORIES

Property	Specification
Remanence	>1.3T
Polarization	Towards Sensor
Dimensions	Thickness > 0.5 x Diameter (h > 0.5 d) Diameter > Thickness (d > h)
Volume*	$V = \pi \times h \times (d / 2)^2$ Depending

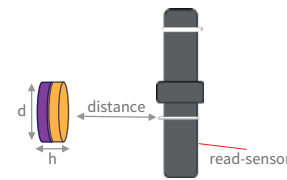
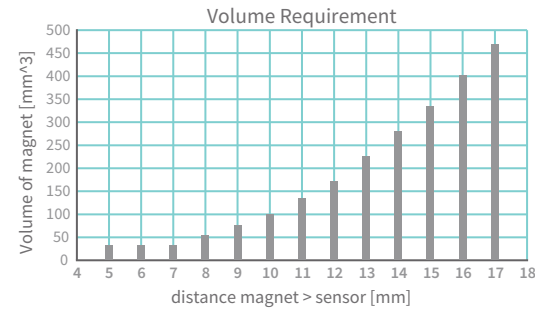

▶ 6-Bolt Magnet



▶ 5-Bolt Magnet

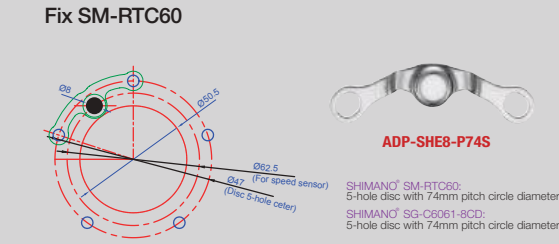

▶ 4-Bolt Magnet

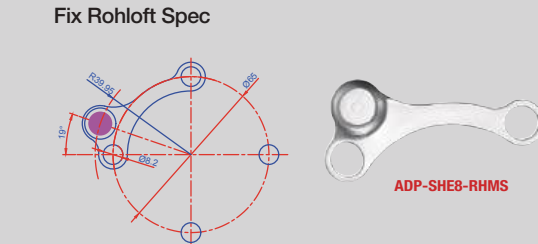

▶ Center Lock Magnet

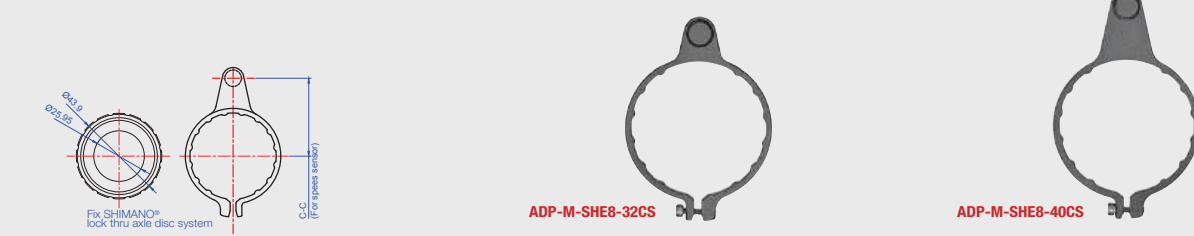

ADP-SHE8-P74S 84-01

For E-bike speed sensor adapter, can fix SHIMANO® SM-RTC60.
MATERIAL: Stainless washer with N45 SH magnet
SPEC: C-C 40mm

ADP-SHE8-RHMS 84-02

E-bike speed sensor adapter of rohloff speed hub E14.
MATERIAL: Stainless washer with N45 SH magnet
SPEC: C-C 40mm

ADP-SHE8-1S ADP-SHE8-2S / ADP-SHE8-3S ADP-SHE8-W60S 84-03

For E-bike speed sensor adapter.
MATERIAL: Stainless washer with N45 SH magnet
SPEC:
 ADP-SHE8-1S: C-C 32mm with 1mm magnet
 ADP-SHE8-2S: C-C 32mm with 2mm magnet
 ADP-SHE8-3S: C-C 40mm with 2mm magnet
 ADP-SHE8-W60S: C-C 60mm with 2mm magnet

ADP-SHE8-WS 85-01

Washer of SHIMANO® disc rotor.
MATERIAL: Stainless steel
THICKNESS: 0.5mm

ADP-SHE8-HS 85-02

For E-bike speed sensor adapter.
MATERIAL: Stainless washer with N45 SH magnet
SPEC: C-C 32mm with 1mm magnet

ADP-M-SHE8-32CS ADP-M-SHE8-40CS 85-03

Locking adapter for E-bike speed sensor.
MATERIAL: AL6061 washer with N45 SH magnet
SPEC:
 ADP-M-SHE8-1: C-C 32mm with 2mm magnet
 ADP-M-SHE8-2: C-C 40mm with 2mm magnet

ADP-SH2 85-04

SHIMANO® center-lock disc hub adapter
 Stainless steel washer with alloy nut

ADP-SH1 85-05

SHIMANO® center-lock disc hub adapter
 Stainless steel washer with alloy nut

ADP-SH1220 85-06

SHIMANO® center-lock 12 / 20mm thru-axle disc hub adapter.
 With alloy locking (M-SH3611)
OPTION: Cr-Mo lock ring (M-SH1521-CR)

NEW ADP SHE8-MSH44-19 ADP SHE8-MSH44-32 85-07

Center lock with integrated N45 SH magnet for E-BIKE speed sensor.
MATERIAL: AL6061-T6 /N45 SH magnet
 Center lock OD/44MM
SPEC:
 ADP SHE8-MSH44-19: C-C 19mm with 3mm magnet
 ADP SHE8-MSH44-32: C-C 32mm with 3mm magnet

ADP-DISC-SH-F 85-08

Center lock system.
 With alloy locking.
 Front 15mm boost hub adapter for 100mm transform to 110mm hub.

ADP-DISC-SH-R 85-09

Center lock system.
 With alloy locking.
 Rear 12mm boost hub adapter for 142mm transform to 148mm hub.

ADP-DISC-R6 85-10

Rear 12mm boost hub adapter for 142mm transform to 148mm hub.

ADP-DISC-F 85-11

Front 15mm boost hub adapter for 100mm transform to 110mm hub.

ACCESSORIES



THRU AXLE

QUICK RELEASE

SEAT CLAMP

TOP CAP

HEADSETS PARTS

CRANK SET

CHAINING SYSTEM

E-BIKE SYSTEM

ROLLER KIT SERIES

BMX SERIES

CHAINING PARTS

CHAIN GUIDE SYSTEM

BRAKE SYSTEM

SEATPOST

STEM SYSTEM

HANDLEBAR

AEROBAR SYSTEM

COMPUTER MOUNT

CAGE

ACCESSORIES

FITTING EQUIPMENT

PEDALS

OUTDOOR GEAR



NEW
CL-ISPEC-2 86-01

SHIMANO® SL-RS700 I-SPEC-2 flat bar shift lever to clamp type.

MATERIAL: AL6061-T6
SPEC: I-SPEC-2
COLOR: Sand blast black



EV-CLAMP-21 86-02

Shifter (shift lever) I-SPEC-EV mount.

MATERIAL: AL6061-T6
COMPATIBILITY HANDLEBAR: 22.2mm
COMPATIBILITY SHIFT LEVER: SHIMANO®

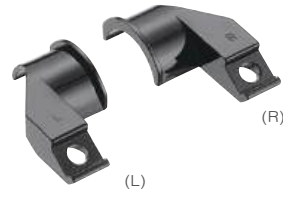

ADP-ISPEC2 86-03

SHIMANO® disc brake lever can fit SRAM® shift lever.

MATERIAL: AL6061-T6
WEIGHT: 16.2g/set



PUL-SR-EG1214 87-01

Fix SRAM® X01 Eagle pulley.

MATERIAL: AL7075 CNC made
TEETH: 12T upper / 14T bottom
BEARING OPTION:
With 607R
Cr-Mo steel seal bearing
Ceramic ball seal bearing



PUL-SH-1313 87-02

MATERIAL: AL7075 CNC made
TEETH: 13T
BEARING OPTION:
With 607R
Cr-Mo steel seal bearing
Ceramic ball seal bearing



PUL-J1-13 87-03

For SHIMANO® 1x12 speed, with Cr-Mo steel bearing.

MATERIAL: Nylon
TEETH: 13T



PUL-P13-E 87-04

For SHIMANO® 1x12 speed.

MATERIAL: Nylon
TEETH: 13T



ADP-EVMX22 86-04

Adapter for SRAM disc brake lever to SHIMANO shift lever with screw and nut.

MATERIAL: Forged AL6061T6
SPEC: SRAM MMX system to SHIMANO I-SPEC-EV system
COLOR: Sand blast black



ADP-ISPEC-EV 86-05

SHIMANO® disc brake lever can fix SRAM® shift lever. With special screw and nut.

MATERIAL: AL6061 -T6
SPEC: I-SPEC-EV



ADP-ISPEC-EV-21 86-06

SHIMANO® disc brake lever can fix SRAM® shift lever. With special screw and nut. Left & right same angle.

MATERIAL: AL6061 -T6
SPEC: I-SPEC-EV



CL-STEMDR1 86-07

Down tube shifter mount to stem tube.

SPEC: Ø28.6, Ø22.2
Fit SHIMANO® 9 speed & 10 speed



CL-HBDR1 86-08

Down tube shifter mount to handlebar.

SPEC: Clamp Ø26 with Ø24 & Ø22.2 Shim
Fit SHIMANO® 9 speed & 10 speed



CL-DTDR1 86-09

Down tube shifter mount.

SPEC: Ø31.8 (With Ø28.6 Shim)
Fit SHIMANO® 9 speed & 10 speed



NEW
CL-ST22/CL-ST24 86-10

Clamp for ROAD bike lever.

MATERIAL: stainless
SPEC: CL-ST22: Ø22.2 × 12.5L, M5
CL-ST24: Ø24 × 14.9L, M6



CS-38 / CS-38B 86-11

Cable adjustable.

MATERIAL: AL6061-T6

Specifications are subject to change without notice.



PUL-75W1 87-05

The wave shape design increases contact surface. Not for chain connectors.

MATERIAL: AL7075-T651 CNC made
TEETH: 11T
BEARING OPTION:
Cr-Mo steel seal bearing
Ceramic ball seal bearing
Customized design CNC parts available



PUL-10 87-06

MATERIAL: AL6061 CNC made
BEARING OPTION:
With 607R
Cr-Mo steel seal bearing
Ceramic ball seal bearing
TEETH: 10T

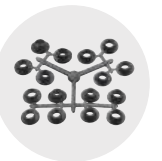

PUL-75C5 87-07

MATERIAL: AL7075-T651 CNC made
TEETH: 11T
BEARING OPTION:
Cr-Mo steel seal bearing
Ceramic ball seal bearing
Customized design CNC parts available
OPTION: 12T / 13T / 14T / 15T



PUL-02 87-08

MATERIAL: AL6061
BEARING OPTION:
With 607R
Cr-Mo steel seal bearing
Ceramic ball seal bearing
TEETH: 10T

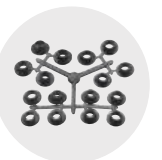

PUL-75C1 87-09

MATERIAL: AL7075-T651 CNC made
TEETH: 11T
BEARING OPTION:
Cr-Mo steel seal bearing
Ceramic ball seal bearing
Customized design CNC parts available
OPTION: 12T / 13T / 14T / 15T



PUL-110 87-10

MATERIAL: AL6061 CNC made
BEARING OPTION:
With 607R
Cr-Mo steel seal bearing
Ceramic ball seal bearing
TEETH: 11T

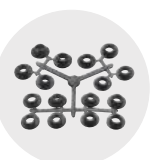

PUL-P11 87-11

MATERIAL: Nylon
TEETH: 11T



PUL-140 87-12

MATERIAL: AL6061
BEARING OPTION:
With 607R
Cr-Mo steel seal bearing
Ceramic ball seal bearing
TEETH: 14T

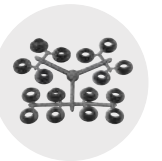

ACCESSORIES



M5A10K 88-01

Special shape of the screw which can cover the bottle cage hole on the frame.

MATERIAL: AL7075
SPEC: M5 x 0.8
LENGTH: 10mm
MAX: 6N.m
WEIGHT: 1.4g/pcs



M517-F 88-02

For water bottle cage.

MATERIAL: AL7075 forged
SPEC: M5 x 0.8
LENGTH: 12mm or 16mm
COLOR: As Order
MAX: 6N.m
OPTION: Torx 25 available
WEIGHT: 1g/pcs (12mm)



M630-F 88-03

For top cap.

MATERIAL: AL7075-T73
SPEC: M6 x 1.0
LENGTH: 30mm
COLOR: As Order
WEIGHT: 2.8g/pcs



M512 / M515 M517 88-04

For water bottle cage.

MATERIAL: AL7075 CNC made
SPEC: M5 x 0.8
LENGTH: 12mm / 15mm / 17mm
MAX: 6N.m
WEIGHT: 1.3g/pcs



MCK-10 88-05

Chainring bolt.

MATERIAL: AL7075 CNC made
W: 5mm or 7mm
OPTION: 1. Torx 30 available
2. AR-12 x 10 (H: 2.5mm)
WEIGHT: 2g (5mm)



M103 88-06

Pivot nut for frame.

SPEC: M10 x 1.0
OPTION: M103E (M10 x 1.25)



M083 88-07

Pivot nut for front fork.

SPEC: M8 x 1.25



PLUG-IST-P01-MTB 88-08

Expander end cap for MTB. For handlebar ID: Ø17 - Ø21mm. (T: 2.6 - 0.6mm)

MATERIAL: Plastic body with stainless screw



PLUG-IST-P01-RC 88-09

Expander end cap for Road bike. For handlebar ID: Ø17 - Ø21mm. (T: 2.6 - 0.6mm)

MATERIAL: Plastic body with stainless screw



PLUG-PAN015 88-10

CNC bar end cap for Road bike.

MATERIAL: AL6061-T6 cap & silicone insert
WEIGHT: 37.5g/set
Not available in Japan



PLUG-12 / PLUG-13 88-11

For MTB & BMX bike.

MATERIAL: AL6061-T6
SPEC: Ø22.2



PLUG-24C 88-12

For Road bike.

MATERIAL: Plastic & Carbon fiber
SPEC: Ø22.2



ADP-FAPOST 88-13

Flat mount to post mount adapter.

MATERIAL: AL6061-T6
WEIGHT: 33g/pcs



ADP-FA1416 88-14

For mounting SHIMANO® flat mount calipers on flat mount fork.

MATERIAL: AL6061-T6
Fits 140mm / 160mm rotor



ADP-FA-R16 88-15

For mounting SHIMANO® flat mount calipers on flat mount frame.

MATERIAL: AL6061-T6
Fits 160mm rotor

Post mount disc brake adapter SPEC list:

ITEM / SPEC	140-160mm	160-180mm	160-203mm	160-220mm	180-203mm	203-220mm
ADP-PM1622				•		
ADP-PM1820					•	
ADP-PM20-220						•
ADP-STD1618		•				
ADP-PM1618	•	•				
ADP-PM1620			•			



ADP-RFA-P14 89-02

For flat mount frame adapter to post mount caliper.

MATERIAL: AL 6061-T6
SPEC: For 140mm/m rotor
WEIGHT: 16g/pcs



ADP-RFA-P16 89-03

For flat mount frame adapter to post mount caliper.

MATERIAL: AL 6061-T6
SPEC: For 160mm/m rotor
WEIGHT: 23g/pcs



ADP-RFA-P18 89-04

For flat mount frame adapter to post mount caliper.

MATERIAL: AL 6061-T6
SPEC: For 180mm/m rotor
WEIGHT: 26g/pcs



ADP-PM1622 89-05

Post mount disc brake adapter. Adapter for 160mm to 220mm disc rotor.

MATERIAL: AL6061-T6
POST MOUNT: 74mm



ADP-PM1820 89-06

Post mount disc brake adapter. Adapter for 180mm to 203mm disc rotor.

MATERIAL: AL6061-T6
POST MOUNT: 74mm
WEIGHT: 14g/pcs



ADP-PM20-220 89-07

Post mount disc brake adapter. Adapter for 203mm to 220mm disc rotor.

MATERIAL: AL6061-T6
POST MOUNT: 74mm



ADP-STD1618 89-08

Post mount disc brake adapter. Adapter for 160mm to 180mm disc.

MATERIAL: AL6061-T6
WEIGHT: 18.5g/pcs

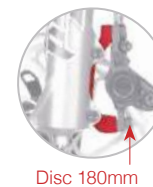

ADP-PM1618 89-09

Post mount disc brake adapter. Adapter for 140mm to 160mm / 160mm to 180mm disc.

MATERIAL: AL6061-T6
POST MOUNT: 74mm
WEIGHT: 10.5g/pcs

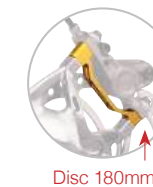

ADP-PM1620 89-10

Post mount to post mount for 203mm rotor only. Adapter for 160mm rotor to 203mm disc.

MATERIAL: AL6061-T6
POST MOUNT: 74mm
WEIGHT: 23g/pcs



ACCESSORIES



PU-TLR 90-01

For tubeless ready rims tape.

MATERIAL: PET
SPEC: 19mm x 50M
 22mm x 50M
 33mm x 50M



NZ-TUSH-F 90-02

The multi-vent valve allows users to pump up tyres quickly and also works with most of the foam-inserted tubeless tyres.

MATERIAL: AL6061-T6 with NBR taper cone spacer
SPEC: Presta valve
LENGTH: 47, 52, 62, 72, 87, 107mm

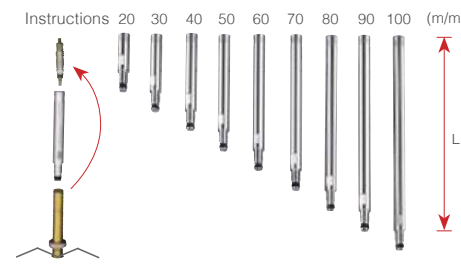

NZ-HF 91-01

MATERIAL: AL6061-T6
SPEC: Presta valve
LENGTH: 20 - 100mm
OPTION: NZ-HF-TL



NZ-F 91-02

MATERIAL: AL6061-T6
SPEC: Presta valve
LENGTH: 25, 38, 50 - 100mm



NZ-HF-TL 91-03

Valve tool.
MATERIAL: AL6061
COLOR: As Order



NZ-TUS-F 90-03

Tubeless valve.

MATERIAL: AL6061 with NBR tapped spacer
SPEC: Presta valve
LENGTH: 40, 45, 60, 70mm
 With NZ-CN5



NZ-GH 90-04

Tubeless valve (removable type) extender, can easily fixed by outer threaded nut.

MATERIAL: AL6061
SPEC: Tubeless Valve
LENGTH: 40, 60mm
OPTION: NZ-HF-TL



NZ-TL-TUS 90-05

Valve tool.

MATERIAL: Nylon, Alloy
COLOR: Black



NZ-CN5 90-06

Tubeless Valve cap.

MATERIAL: Nylon
SPEC: Presta Valve



NZ-AMTUS-F 90-07

Tubeless Valve for USA valve.

MATERIAL: AL6061 with NBR tappr spacer
SPEC: USA Valve
LENGTH: 40mm



NZ-NUT5 90-08

Special nut for tubeless presta valve, compatible with NZ-TL-TUS.

MATERIAL: AL6061
COLOR: BK
WITH: O-ring



Tubeless SET 90-09

Tubeless ready kit contains everything you need to complete your tubeless set-up.

SPEC: RIM TAPE (PU-TLR) x 1 roll
 WIDTH OPTION: 19mm x 50M / 22mm x 50M / 33mm x 50M
 TUBELESS VALVE (NZ-TUS-F) x 2 pcs
 LENGTH OPTION: 40mm / 45mm / 60mm / 70mm
 VALVE TOOL (NZ-TL-TUS) x 1 pcs
 VALVE CAP (NZ-CN5) x 2 pcs
OPTION: NZ-GH



ADP-CO2-A1 91-04

Fits presta & USA valve without adapter. The simple threaded valve allows easy inflation.

MATERIAL: AL6061-T6 full CNC made



NZ-DISC 91-05

MATERIAL: AL6061-T6
SPEC: Disc wheel 90 degree adapter



NZ-UF 91-06

MATERIAL: Copper or AL6061-T6
SPEC: Presta change to USA valve

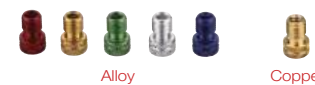

NZ-KUF 91-07

With key ring.

MATERIAL: Copper or AL6061-T6
SPEC: Presta change to USA valve

ACCESSORIES



NZ-01

92-01

MATERIAL: AL6061-T6
SPEC: USA valve



NZ-B5-WE

92-02

MATERIAL: AL6061-T6
SPEC: Presta valve



NZ-B1

92-03

MATERIAL: AL6061-T6
SPEC: USA valve



NZ-B2

92-04

MATERIAL: AL6061-T6
SPEC: USA valve



NZ-B3

92-05

MATERIAL: AL6061-T6
SPEC: USA valve



NZ-B4F

92-06

MATERIAL: AL6061-T6
SPEC: Presta valve



NZ-KULO

92-07

MATERIAL: Nylon plastic
SPEC: USA valve



NZ-KN

92-08

MATERIAL: Nylon plastic
SPEC: USA valve



NZ-18

92-09

MATERIAL: AL6061-T6
SPEC: USA valve



NZ-B6

92-10

MATERIAL: AL6061-T6
SPEC: USA valve



NZ-08

92-11

MATERIAL: AL6061-T6
SPEC: USA valve



NZ-FT

92-12

MATERIAL: AL6061-T6
SPEC: USA valve

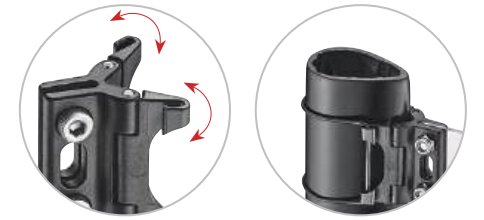
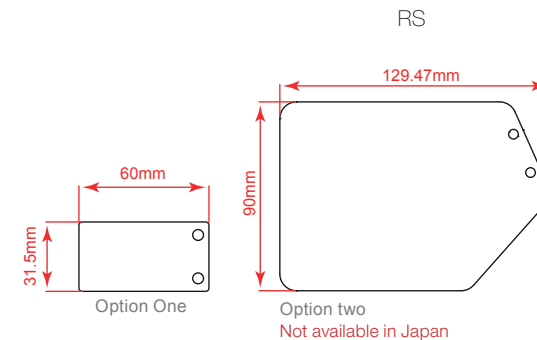

Can be adjusted

For aero seatpost

NAME-AER017 NAME-AER017-RS

93-01

With bolt.
For easy drill card hold.
For aero seatpost.

WEIGHT: 14g/set



NAME-P NAME-P-RS

93-02

With bolt.
For easy drill card hold.

WEIGHT: 15g/set



NAME-AERO NAME-AERO-RS

93-03

Special design available.

WEIGHT: 12.5g/set



WG-24F

93-04

Cold forged.

MATERIAL: AL6061-T6
SPEC: Ø34.9mm
COLOR: As Order
Custom design available

RS-MINI BAR

93-05

Create an additional hand position
on the handlebar.
Minimizes hand numbness, carpal
and ulnar issues.

MATERIAL: Nylon
SPEC: ID Ø22.2mm
WEIGHT: 17.8g/set



NEW

RS-MINI BAR-02

93-06

New design can combination with
lock-on grip.

MATERIAL: Nylon
WEIGHT: 30.4g/set

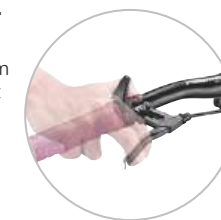

ACCESSORIES

► TL-101-1 Features: Combo pliers content

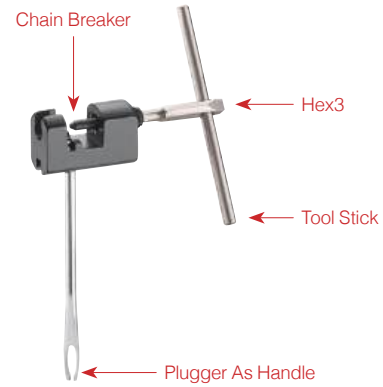
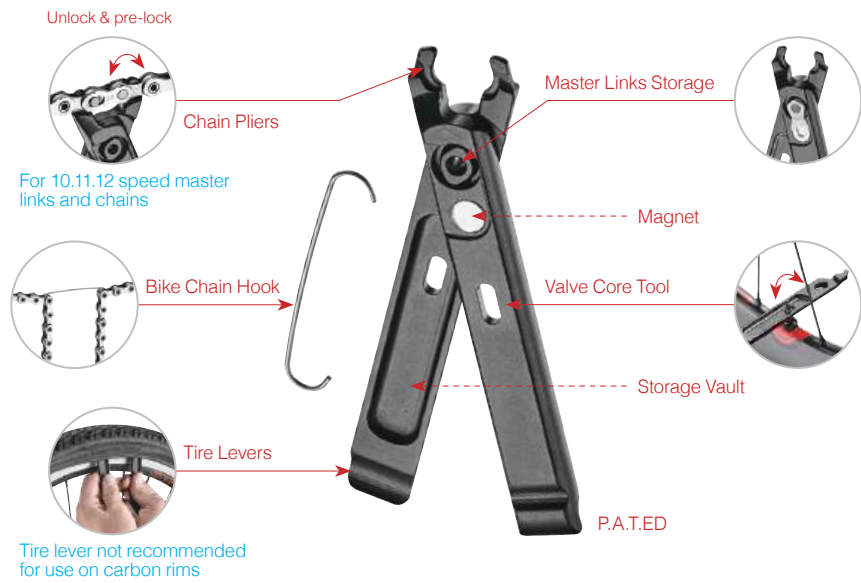

► TL-102-1 Features: Tubeless repair kit

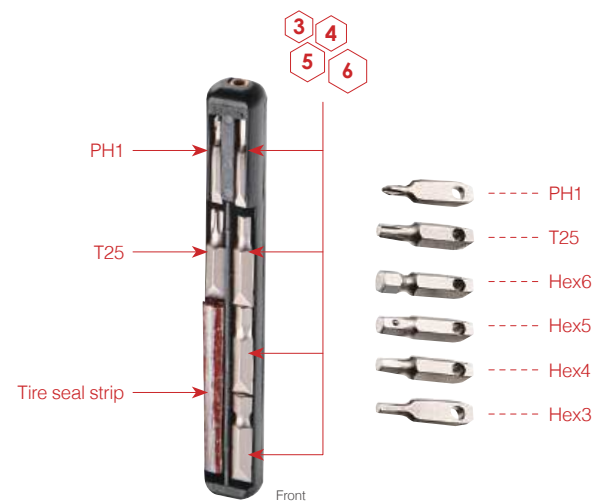

TL-500

94-01

End cap style storage for MTB alloy handle bar.

COMBO PLIER FEATURES:
Master link tool / Master link storage / Valve core tool / Tire lever / Bike chain hook / Storage vault
Patent in multiple countries
MATERIAL: Forged alloy and CNC machined
WEIGHT: 38.5g
TUBELESS REPAIR KIT CONTENT:
Reamer / Plugger / Tire seal strip
6 PCS BITS CONTENT:
Hex3 / 4 / 5 / 6 / PH1 / T25 with tool stick

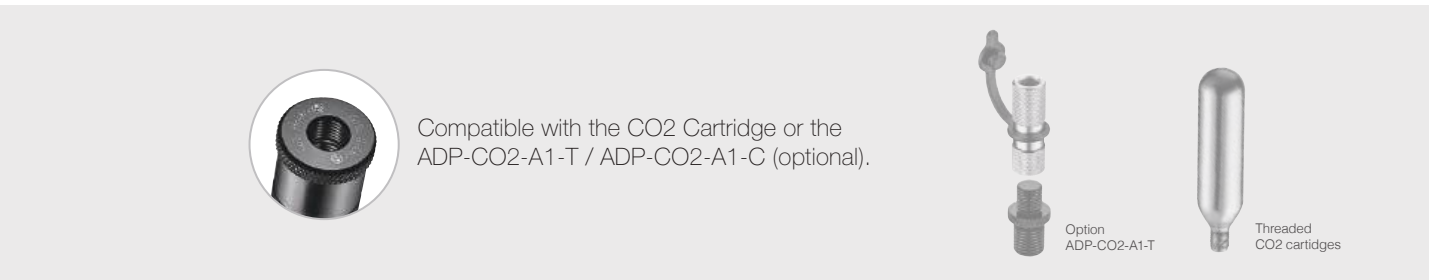

TL-102

Storage tube with multi tool.

TUBELESS REPAIR KIT CONTENT:
Reamer / Plugger / Tire seal strip
6 PCS BITS CONTENT:
Hex3 / 4 / 5 / 6 / PH1 / T25 with tool stick



TL-101

Storage tube with multi tool.

COMBO PLIER FEATURES:
Master link tool / Master link storage / Valve core tool / Tire lever / Bike chain hook / Storage vault
Patent in multiple countries
MATERIAL: Forged alloy and CNC machined



TL-600

95-03

Multi tool storage tube with CO2 cartridges thread.

COMBO PLIER FEATURES:
Master link tool / Master link storage / Valve core tool / Tire lever / Bike chain hook / Storage vault
Patent in multiple countries
MATERIAL: Forged alloy and CNC machined
WEIGHT: 38.5g
TUBELESS REPAIR KIT CONTENT:
Reamer / Plugger / Tire seal strip
6 PCS BITS CONTENT:
Hex3 / 4 / 5 / 6 / PH1 / T25 with tool stick



TL-700

95-04

Multi tool storage tube with CO2 cartridges thread. compatible ADP-CO2-A1-T.
Include tube holder WB-UHD-22 for two pieces.

COMBO PLIER FEATURES:
Master link tool / Master link storage / Valve core tool / Tire lever / Bike chain hook / Storage vault
Patent in multiple countries
MATERIAL: Forged alloy and CNC machined
WEIGHT: 38.5g
TUBELESS REPAIR KIT CONTENT:
Reamer / Plugger / Tire seal strip
6 PCS BITS CONTENT:
Hex3 / 4 / 5 / 6 / PH1 / T25 with tool stick



ACCESSORIES



TL-750 96-01

Multi tool storage tube with CO2 cartridges thread. compatible ADP-CO2-A1-T. Include tube holder WB-UHD-22 for two pieces and end cap style storage TL-501 for MTB alloy handle bar.

COMBO PLIER FEATURES:
Master link tool / Master link storage / Valve core tool / Tire lever / Bike chain hook / Storage vault
Patent in multiple countries
MATERIAL: Forged alloy and CNC machined
WEIGHT: 38.5g
TUBELESS REPAIR KIT CONTENT:
Reamer / Plugger / Tire seal strip
6 PCS BITS CONTENT:
Hex3 / 4 / 5 / 6 / PH1 / T25 with tool stick

P.A.T.E.D
Front Back



TL-101-1 97-01

6 function pliers.
COMBO PLIERS CONTENT:
Master link tool / Master link storage / Valve core tool / Tire lever / Storage vault / Bike chain hook
MATERIAL:
Forged AL+CNC machined
WEIGHT: 38.5g/pcs
Patent in multiple countries

P.A.T.E.D



TL-500-1 97-02

MTB handlebar end cap with special multi-tool storage space. (not included multi-tool)
SPEC: For handlebar ID Ø17.5 - Ø20.5mm
MATERIAL: TPEE



TL-105 97-03

Stainless steel plate nylon container.
CONTENT:
Spoke wrench x 1pcs / Patch x 12pcs
Tire seal strip x 5pcs / Self-adhesive patch x12pcs
Grinder x 1pcs

TL-105-E 97-04

CONTENT:
Stainless steel Bracket x 1pc / Nylon container x 1pc



TL-801 96-02

Multi tool storage long tube with CO2 cartridges thread. compatible ADP-CO2-A1-T. Include tube holder WB-UHD-22 for two pieces and end cap style storage TL-501 for MTB alloy handle bar. Bicycle pump compatible Presta and Schrader valve.

COMBO PLIER FEATURES:
Master link tool / Master link storage / Valve core tool / Tire lever / Bike chain hook / Storage vault
Patent in multiple countries
MATERIAL: Forged alloy and CNC machined
WEIGHT: 38.5g
TUBELESS REPAIR KIT CONTENT:
Reamer / Plugger / Tire seal strip
6 PCS BITS CONTENT:
Hex3 / 4 / 5 / 6 / PH1 / T25 with tool stick

P.A.T.E.D
Front Back



TL-800 96-03

Multi tool storage long tube with CO2 cartridges thread. compatible ADP-CO2-A1-T. Include tube holder WB-UHD-22 for two pieces and end cap style storage TL-501 for MTB alloy handle bar. Bicycle pump compatible Presta and Schrader valve.

COMBO PLIER FEATURES:
Master link tool / Master link storage / Valve core tool / Tire lever / Bike chain hook / Storage vault
Patent in multiple countries
MATERIAL: Forged alloy and CNC machined
WEIGHT: 38.5g
TUBELESS REPAIR KIT CONTENT:
Reamer / Plugger / Tire seal strip
6 Pcs bits content:
Hex3 / 4 / 5 / 6 / PH1 / T25 with tool stick
ADP-CO2-A1-T:
Connect with storage tube through adapter
Fits Presta & USA valve
The simple threaded valve allows easy inflation

P.A.T.E.D
Front Back

ADP-CO2-A1-C



F-STRAP-BAG 97-05

Quick and easy to carry repair kits when long distance riding, include mounting bag to helpful for sorting kit.
VELCRO LENGTH: 58cm



Spare part are not included.



F-STRAP 97-06

Quick and easy to carry repair kits when long distance riding.
VELCRO LENGTH: 58cm



Spare part are not included.



THRU AXLE

QUICK RELEASE

SEAT CLAMP

TOP CAP

HEADSETS PARTS

CRANK SET

CHAINING SYSTEM

E-BIKE SYSTEM

ROLLER KIT SERIES

BMX SERIES

CHAINING PARTS

CHAIN GUIDE SYSTEM

BRAKE SYSTEM

SEATPOST

STEM SYSTEM

HANDLEBAR

AEROBAR SYSTEM

COMPUTER MOUNT

CAGE

ACCESSORIES

FITTING EQUIPMENT

PEDALS

OUTDOOR GEAR

ACCESSORIES



NEW
SDM-HANGER-001 98-01
 FIT 2023 GIANT® TCR & PROPEL & DEFY.
 MATERIAL: AL6061-T6
 Customized available



UDH-HANGER 98-02
 The Universal Derailleur Hanger.
 MATERIAL: AL6066-T6 / Nylon
 WEIGHT: 27g/pcs



RH-WOT-0 98-03
 Rear derailleur hanger extension.
 MATERIAL: AL6061-T6
 COLOR: As Order



R2 / R2-X 98-04
 Rear derailleur protector.
 R2: Compatible quickrelease dropout.
 R2-X: Compatible SHIMANO® shadow derailleur.



RL-85V 98-05
 Canti brake rear hanger



RL-85EC 98-06
 Canti brake rear hanger



RG-AK1 98-07
 Stem spacer ring bell OD Ø28.6mm



RG-ARK 98-08
 Stem spacer ring bell OD Ø28.6mm



NEW
ADP-BT-S 99-01
 Holder for SRAM® AXS/ ETAP battery.
 MATERIAL: Nylon66
 COLOR: Black
 With cable tie
 Battery not included



TK-ATG01 99-02
 Top cap with Air Tag holder, special locking tool include.
 MATERIAL: Top cap: AL6061
 Tool: Nylon
 WEIGHT: 28g/set
 Air Tag not included



WB-ATG-02 99-03
 Air Tag holder that mount on the bike frame water bottle attachment point, and zip tip under the bike saddle rail.
 MATERIAL: Nylon66
 COLOR: Black
 WEIGHT: 23g/pcs (With bolt)
 Air Tag not included



TL-3X-65 / TL-3X-80
TL-3X-B65 / TL-3X-B80 BEST SELLER 99-04
 MATERIAL: Heat treated steel (ASM 6150)
 Nylon body
 LENGTH: 65mm, 80mm
 ALLENKEY TYPE: 4mm, 5mm, 6mm
 Customer with logo available



M-BOT-A
 (Only for front wheel)



M-BOT-C
 (For front and rear wheel)



M-BOT-A / M-BOT-C 99-05
 Lamp peg & R.D protector.
 MATERIAL:
 M-BOT-A: AL6061-T6
 M-BOT-C: Carbon

NEW
ANTI NUT CO-L(AM) 99-06
 MATERIAL: STEEL NUT / AL6061T6 CONE
 SPEC: M9*1.0, M10*1.0, 3/8*26T
 LENGTH: 30mm
 With special allen key



NEW
ANTI NUT CO-L(OE) 99-07
 MATERIAL: STEEL
 SPEC: M9*1.0, M10*1.0, 3/8*26T
 LENGTH: 23mm / 28mm
 With special allen key



THRU AXLE

QUICK RELEASE

SEAT CLAMP

TOP CAP

HEADSETS PARTS

CRANK SET

CHAINING SYSTEM

E-BIKE SYSTEM

ROLLER KIT SERIES

BMX SERIES

CHAINING PARTS

CHAIN GUIDE SYSTEM

BRAKE SYSTEM

SEATPOST

STEM SYSTEM

HANDLEBAR

AEROBAR SYSTEM

COMPUTER MOUNT

CAGE

ACCESSORIES

FITTING EQUIPMENT

PEDALS

OUTDOOR GEAR

FITTING EQUIPMENT



ADP-FIT-RHB

101-01

Allow you to find the most appropriate handlebar width swiftly and painlessly. Ease your physical fatigue for long distance riding.

MATERIAL: AL6061
SPEC: 320~440mm
DROP: 125mm
REACH: 70mm

Only for fitting setting not for outdoor riding.



Find your perfect handlebar width swiftly.

ADP-FIT-E220

101-02

Adjustable welding stem.

MATERIAL: AL6066
ANGLE: ±8°
CLAMP HEIGHT: 50mm
C-C: 205mm
STEM TUBE SIZE: Ø28.6m



Only for fitting setting not for outdoor riding.

ADP-FIT-SA

101-03

FORK STACK HIGH: Ø40mm, Ø31.8mm with shim Ø28.6mm
HANDLEBAR CLAMP: Ø31.8mm
LENGTH: 50 - 150mm
ANGLE: ±25°
OPTION: Ø35mm Clamp



NEW ADP-FIT-WR

100-01

Quick and easy to change position for trainer or fitting. Angle adjustment from 0 to 12 degrees. Three wheels allow it to adjust itself.

HEIGHT RANGE: 80- 290 mm

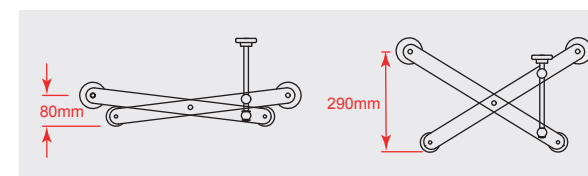

ADP-FIT-XYA

101-04

Stem slimension inspection platform.

MATERIAL: AL6061-T6
SPEC:
HANDLEBAR STEM: Ø31.8 x Ø34.9 x (H)50mm x 1pcs
SPACER: IDØ28.6 x ODØ34.2 x (H)3mm x 2pcs
 IDØ28.6 x ODØ34.2 x (H)5mm x 2pcs
 IDØ28.6 x ODØ34.2 x (H)10mm x 1pcs
 IDØ31.8 x ODØ38.8 x (H)2.5mm x 2pcs
 IDØ31.8 x ODØ38.8 x (H)5mm x 2pcs
 IDØ31.8 x ODØ38.8 x (H)10mm x 1pcs
SHIM-CC-AL: IDØ28.6 x ODØ31.8 x (H)38mm x 1pcs
 IDØ31.8 x ODØ34.9 x (H)58mm x 1pcs
WEIGHT: 2.515kg/set



ADP-FIT-CZ

101-05

Precision CNC machines fitting bike sizing cranks.

CRANK LENGTH: 145,150,155,160,165,167.5,170,172.5, 175,177.5,180mm
AXLE: 24mm / 30mm
MATERIAL: Crank: AL6061-T6
 Axle: AL7075-T651
CHAINRING: Single 46T



PEDALS



No Killer Nail Pedals

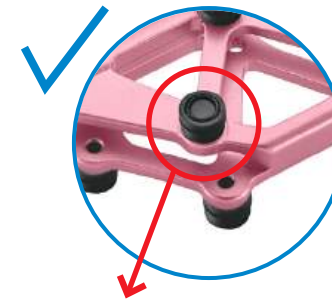

M4 screw
You Need JoJo- nail Pedals
PATENTED,M658172,CN, ZL 2024 2 0439842.6,
CN, ZL 2024 2 0148501.3,P.C.T...

Safety & Anti-slip & Comfort.
Innovation concept combine function and safety, let your ride with confidence.



PD-FRIED EGG



PD-BEETLE



PD-OCTOPUS

Anti-slip soft nails :



Six different colors Aluminium body :



Mr.control



NEW
PD-BEETLE 103-01

Safety & Anti-slip & Comfort
Innovation concept combine function and safety, let you ride with confidence.

MATERIAL:
Body: AL6061T6 CNC made
Axle: Cr-Mo Cold-Forged
PLATFORM SIZE: 100 x 100 x 110 (L2xWxL1)
PIN: 20 per side
WEIGHT: 370g/pair

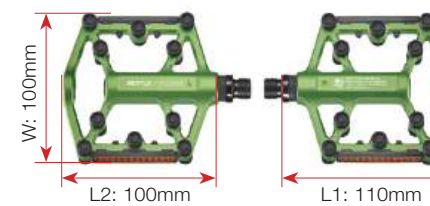

NEW
PD-FRIED EGG 103-02

Safety & Anti-slip & Comfort
Innovation concept combine function and safety, let you ride with confidence.

MATERIAL:
Body: AL6061T6 CNC made
Axle: Cr-Mo Cold-Forged
PLATFORM SIZE: 86 x 100 x 109 (L2xWxL1)
PIN: 20 per side
WEIGHT: 350g/pair

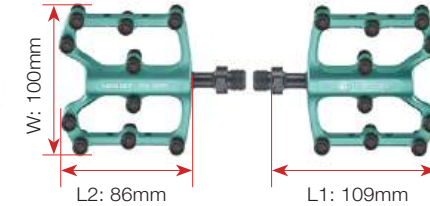

NEW
PD-OCTOPUS 103-03

Safety & Anti-slip & Comfort
Innovation concept combine function and safety, let you ride with confidence.

MATERIAL:
Body: AL6061T6 CNC made
Axle: Cr-Mo Cold-Forged
PLATFORM SIZE: 89 x 98 x 114 (L2xWxL1)
PIN: 16 per side
WEIGHT: 330g/pair

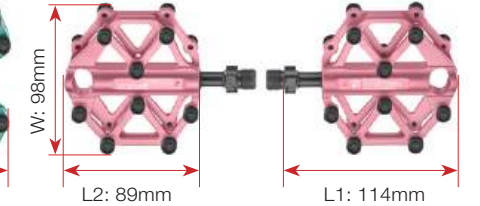

THRU AXLE

QUICK RELEASE

SEAT CLAMP

TOP CAP

HEADSETS PARTS

CRANK SET

CHAINING SYSTEM

E-BIKE SYSTEM

ROLLER KIT SERIES

BMX SERIES

CHAINING PARTS

CHAIN GUIDE SYSTEM

BRAKE SYSTEM

SEATPOST

STEM SYSTEM

HANDLEBAR

AEROBAR SYSTEM

COMPUTER MOUNT

CAGE

ACCESSORIES

FITTING EQUIPMENT

PEDEALS

OUTDOOR GEAR

PEDALS

NEW

PD-FOUR-CLOVER

104-01



Safety & Anti-slip & Comfort
Innovation concept combine function and safety, let your ride with confidence.

MATERIAL:
Body: AL6061T6 CNC made
Axle: Cr-Mo Cold-Forged
PLATFORM SIZE: 75 x 90 x 83 (L2xWxL1)
PIN: 24 per side
WEIGHT: 377g/pair

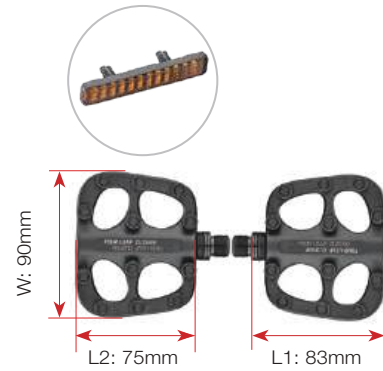

NEW

PD-MODEL Y80

104-02



Safety & Anti-slip & Comfort
Innovation concept combine function and safety, let your ride with confidence.

MATERIAL:
Body: AL6061T6 CNC made
Axle: Cr-Mo Cold-Forged
PLATFORM SIZE: 100 x 80 x 108 (L2xWxL1)
PIN: 20 per side
WEIGHT: 350g/pair

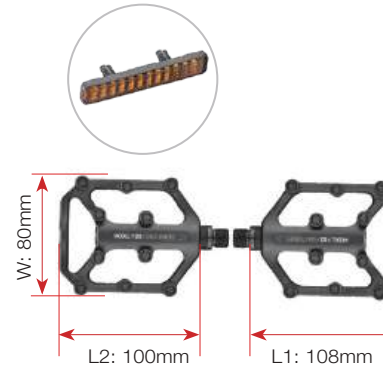

NEW

PD-RIB

104-03



Safety & Anti-slip & Comfort
Innovation concept combine function and safety, let your ride with confidence.

MATERIAL:
Body: AL6061T6 CNC made
Axle: Cr-Mo Cold-Forged
PLATFORM SIZE: 100 x 125 x 108 (L2xWxL1)
PIN: 24 per side
WEIGHT: 437g/pair

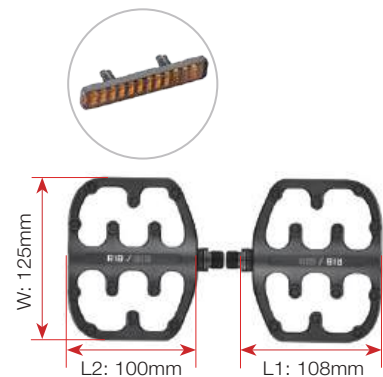

NEW

PD-PEACE

104-04



Safety & Anti-slip & Comfort
Innovation concept combine function and safety, let your ride with confidence.

MATERIAL:
Body: AL6061T6 CNC made
Axle: Cr-Mo Cold-Forged
PLATFORM SIZE: 100 x 124 x 108 (L2xWxL1)
PIN: 24 per side
WEIGHT: 410g/pair

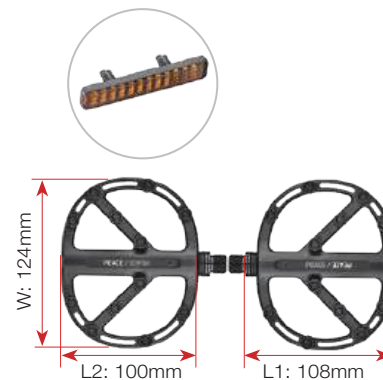

NEW

PD-FOUR-CLOVER 125

104-05



Safety & Anti-slip & Comfort
Innovation concept combine function and safety, let your ride with confidence.

MATERIAL:
Body: AL6061T6 CNC made
Axle: Cr-Mo Cold-Forged
PLATFORM SIZE: 100 x 125 x 108 (L2xWxL1)
PIN: 28 per side
WEIGHT: 484g/pair

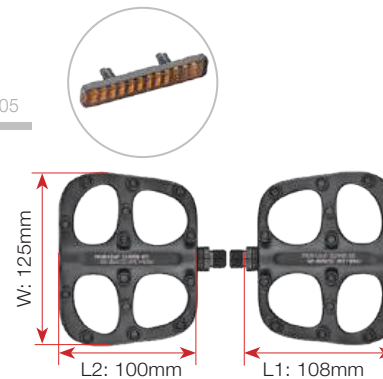

Pedal ALL PRODUCTS

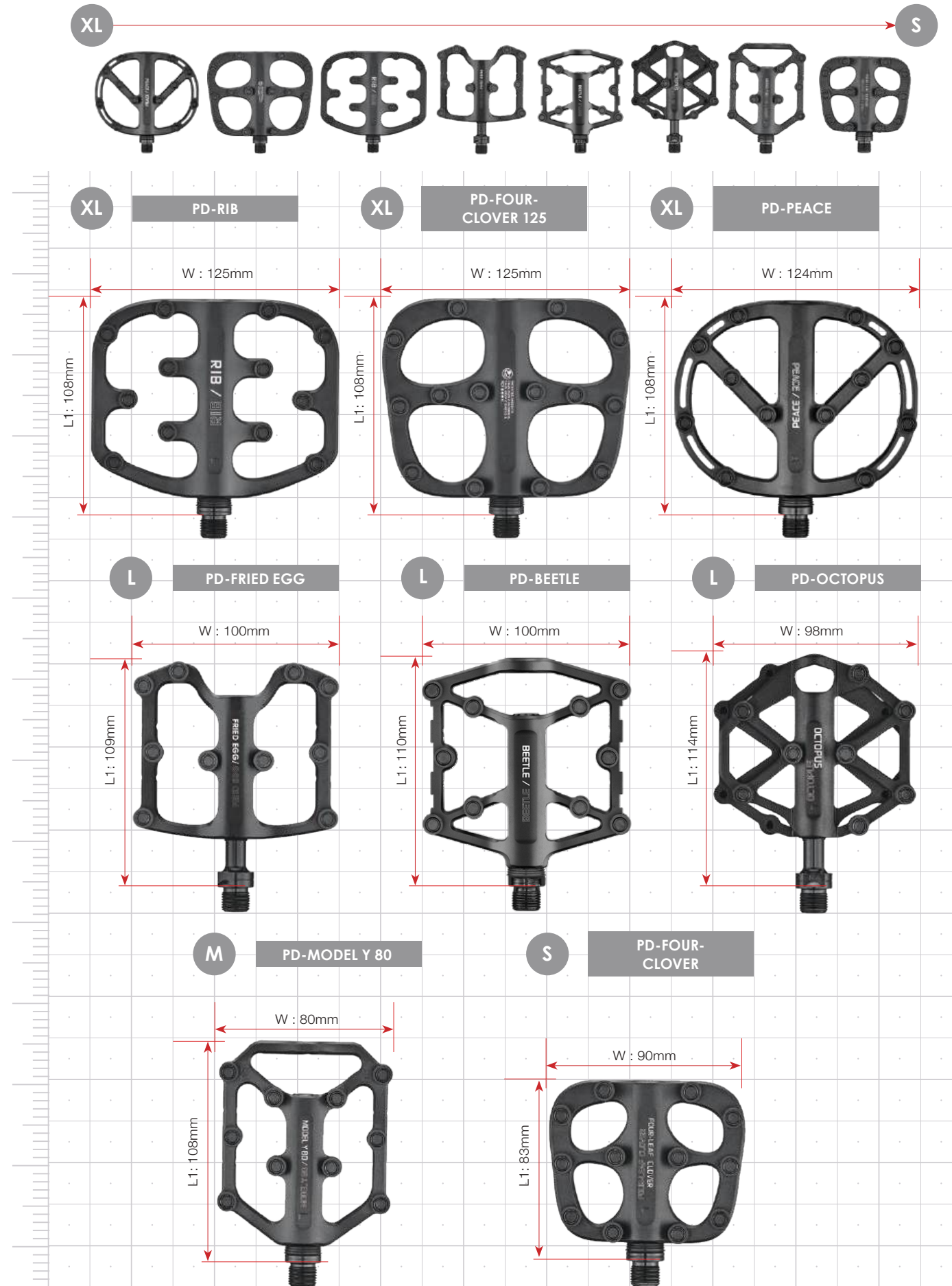

THRU AXLE

QUICK RELEASE

SEAT CLAMP

TOP CAP

HEADSETS PARTS

CRANK SET

CHAINING SYSTEM

E-BIKE SYSTEM

ROLLER KIT SERIES

BMX SERIES

CHAINING PARTS

CHAIN GUIDE SYSTEM

BRAKE SYSTEM

SEATPOST

STEM SYSTEM

HANDLEBAR

AEROBAR SYSTEM

COMPUTER MOUNT

CAGE

ACCESSORIES

FITTING EQUIPMENT

PEDALS

OUTDOOR GEAR

OUTDOOR GEAR



LAI-J-AL

LAI-J-AL/ LAI-J-AL-E

106-01

Can carry in your hand luggage.
Wide Seat Space
A High Back to Support Head and Neck
Recyclable Aluminum Alloy Frame and Tube
An Integrated Bottle Holder, a Cellphone Pouch and a Storage Pocket for your convenience
Max Load: 150 kg
P.A.T. ED World Wide

UNFOLDED DIMENSIONS: 540(W) x 900(H) x 660(D) mm
FOLDED DIMENSIONS: L 130(OD) x 390(L) mm
XL 130(OD) x 450(L) mm

WEIGHT: 1350g
WEIGHT CAPACITY: 150kg
SEAT MATERIAL: 600 D Tetorn
FRAME CONSTRUCTION: Aluminum Alloy
TUBE CONSTRUCTION: Aluminum Alloy

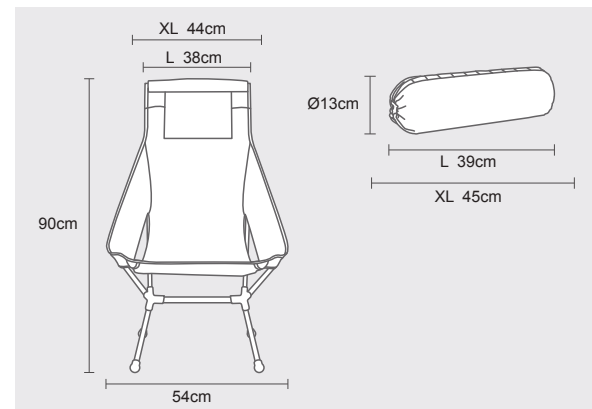
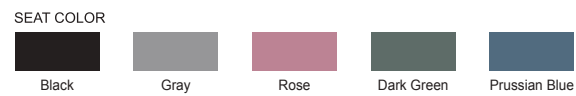

On Bike



LAI-J-CF-E

LAI-J-CF/ LAI-J-CF-E

106-02

Can carry in your hand luggage.
Wide Seat Space
A High Back to Support Head and Neck
Recyclable Aluminum Alloy Frame and Carbon Fiber Tube
An Integrated Bottle Holder, a Cellphone Pouch and a Storage Pocket for your convenience
Max Load: 150 kg
P.A.T. ED World Wide

UNFOLDED DIMENSIONS: 540(W) x 900(H) x 660(D) mm
FOLDED DIMENSIONS: L 130(OD) x 390(L) mm
XL 130(OD) x 450(L) mm

WEIGHT: 1080g
WEIGHT CAPACITY: 150kg
SEAT MATERIAL: 600 D Tetorn
FRAME CONSTRUCTION: Aluminum Alloy
TUBE CONSTRUCTION: Carbon Fiber

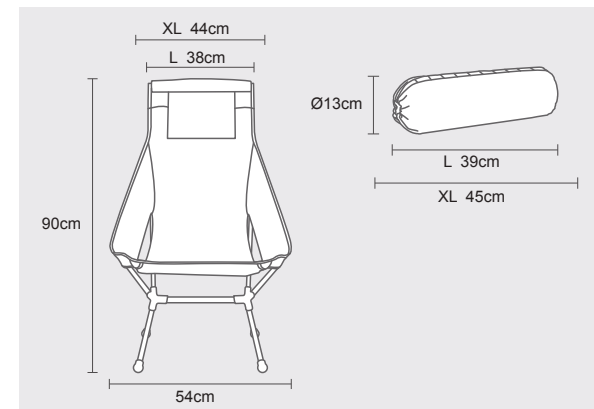
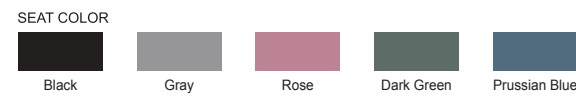

In Bag



In Scooter

NEW LAI-JA

107-01

Meet to Iron Grill Table (IGT) system
Aluminum alloy frame and tubes
The grooves on both sides for hanging items
Can extend upwards with adapters
Aluminum alloy table top is anti-scratch, heat-resistant and easy to clean
Extend the space by using the connecting plate

UNFOLDED DIMENSIONS: 550(W) x 390(H) x 390(D) mm
FOLDED DIMENSIONS: L 150(OD) x 510(L) mm
WEIGHT: 2290g
FRAME MATERIAL: Aluminum Alloy

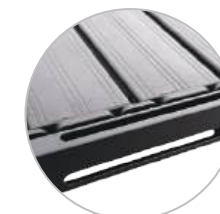
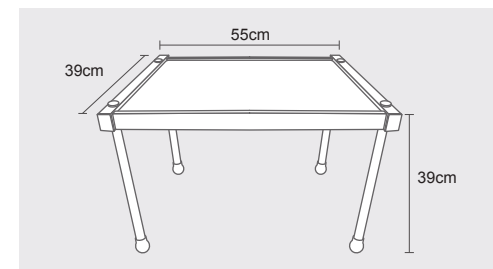

The grooves on both sides



The grooves for connecting plate



Adapters for extend upwards

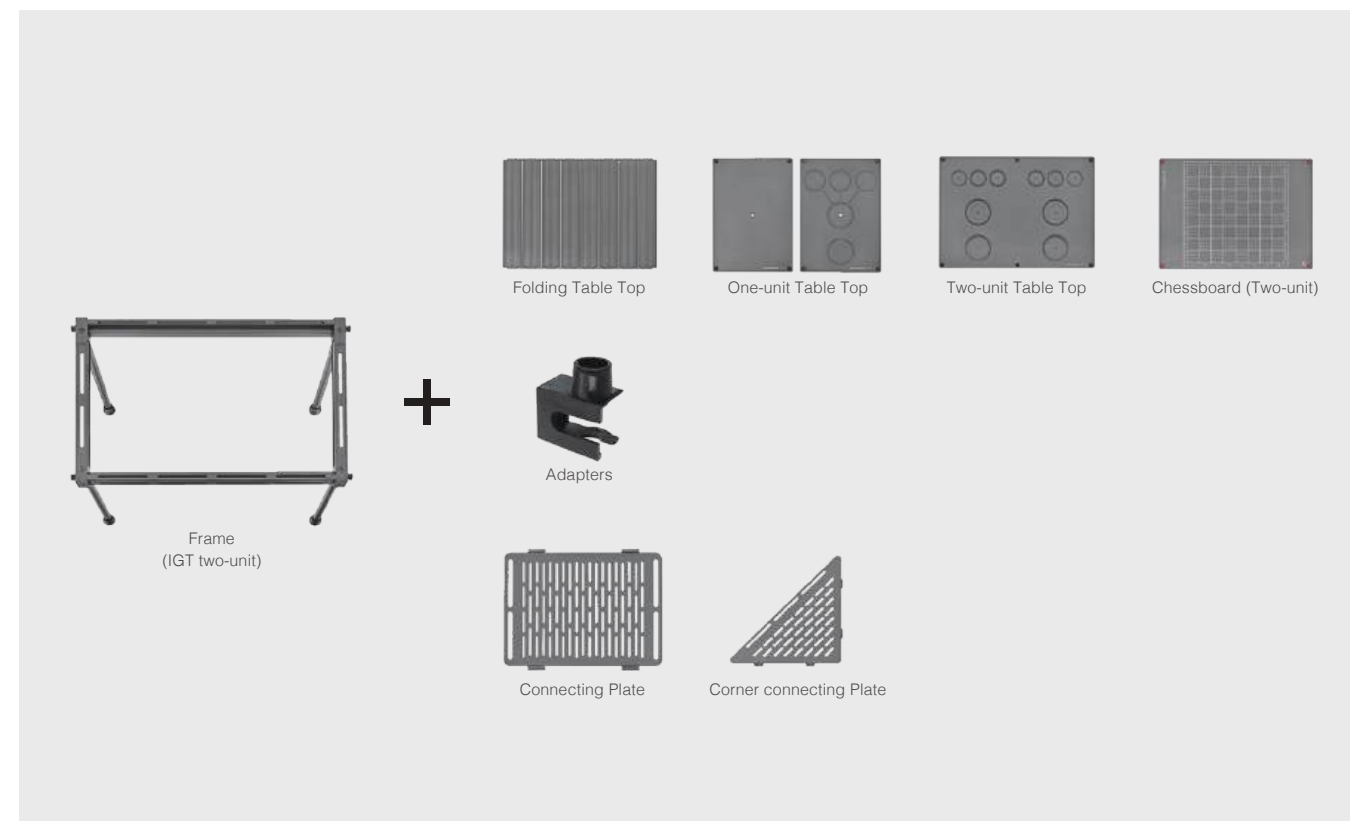

THRU AXLE

QUICK RELEASE

SEAT CLAMP

TOP CAP

HEADSETS PARTS

CRANK SET

CHAINING SYSTEM

E-BIKE SYSTEM

ROLLER KIT SERIES

BMX SERIES

CHAINING PARTS

CHAIN GUIDE SYSTEM

BRAKE SYSTEM

SEATPOST

STEM SYSTEM

HANDLEBAR

AEROBAR SYSTEM

COMPUTER MOUNT

CAGE

ACCESSORIES

FITTING EQUIPMENT

PEDALS

OUTDOOR GEAR

Mr.control™

(PRIME AERO)

LAMINAR ENT. CO., LTD.
LAGEAR ENT. CO., LTD.
禾詰企業有限公司 / 上桂企業有限公司



No. 1, Aly. 207, Ln. 92, Fengnan St., Fengyuan Dist.,
Taichung City 420, Taiwan (R.O.C.)
Tel: +886-4-25391989 Fax: +886-4-25391973
Mail: primaero@ms35.hinet.net
www.mrcontrol-bike.com