

Mr.control™ ~since 1991



2027 **HIGH**
PERFORMANCE
FOR EVERYONE

DROPPER POST



THRU AXLE



SEAT CLAMP



COMPUTER MOUNT



CHAIN GUIDE



CHAIN RING

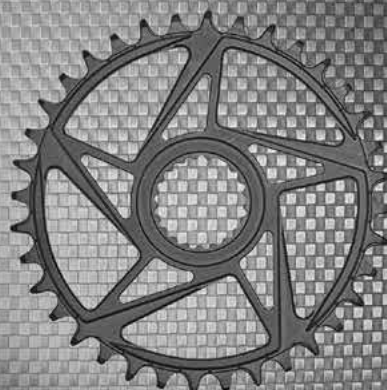

TECHLONOGY	05
THRU AXLE	06
QUICK RELEASE	12
SEAT CLAMP	16
TOP CAP	26
HEADSETS PARTS	28
CRANK SET	32
CHAINRING SYSTEM	34
ROLLER KIT SERIES	38
BMX SERIES	41
CHAINRING PARTS	43
CHAIN GUIDE SYSTEM	45
BRAKE SYSTEM	53
SEATPOST	57
STEM SYSTEM	61
HANDLEBAR	64
AEROBAR SYSTEM	67
COMPUTER MOUNT	69
CAGE	79
ACCESSORIES	81
FITTING EQUIPMENT	102
PEDALS	104

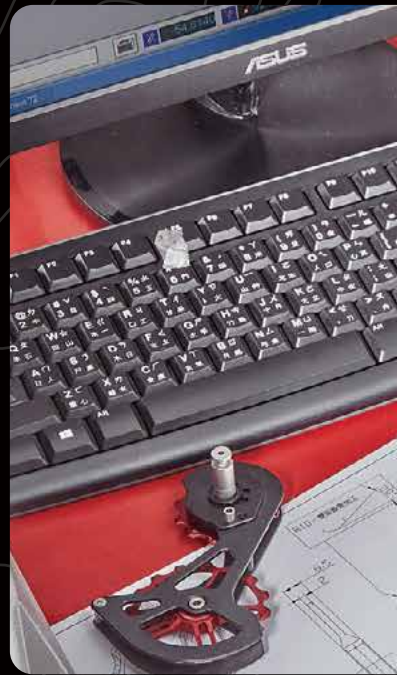



CARBON INJECTION TECHNOLOGY

We started to use carbon Long fibers with nylon Injection to Create carbon high texture lightweight products. Long fibers in the pellet form Advantage.

FATIGUE TESTING MACHINE

To ensure the safety of riders, we thoroughly test every product according to the "CEN" standards. It's our goal to let our riders not only experience lightweight but also safety.

INSPECTION MACHINE

Our lightweight carbon-fiber made products are of the finest quality. To assure this quality, we test our carbon-fiber products from top to bottom with the inspection machine.



MICROCOMPUTER ATTENUATION TESTER

We our pioneers in product quality and know that carbon-fiber is an ambiguous material.

Therefore we also check our carbon-fiber made products' strength by our Microcomputer Attenuation Test. The test puts them under 150kg of pure force, two times, for 30 seconds. The result, a safe and reliable product that every rider can trust.our carbon-fiber products from top to bottom with the inspection machine.

HARDNESS TESTING MACHINE

To assure the intensity and safe structure of our products to meet the international standards, we carry out discreet sample inspection to pass the hardness test. It is important to us that we deliver consistency in our product quality.



COORDINATE MEASURING MACHINE

The coordinate measuring machine is key to reach our goal of high product standards. We only want to provide our customers the best and most excellent quality. Therefore we use 2.5D CMM techniques to test all our products.

EFBE, TESTING CENTER IN GERMANY

After EN testing at Cycling & Health Industry R&D Center (in Taiwan) we send our products for further inspections to EFBE in Germany, so that we can assure our high expectations and meet the international standard.



THRU AXLE

QUICK RELEASE

SEAT CLAMP

TOP CAP

HEADSETS PARTS

CRANK SET

CHAINRING SYSTEM

ROLLER KIT SERIES

BMX SERIES

CHAINRING PARTS

CHAIN GUIDE SYSTEM

BRAKE SYSTEM

SEATPOST

STEM SYSTEM

HANDLEBAR

AEROBAR SYSTEM

COMPUTER MOUNT

CAGE

ACCESSORIES

FITTING EQUIPMENT

PEDALS

THRU AXLE M5 INSIDE

Thru axle for light holder, with M5 and HEX hole in the L/R side, spiry line machined to remove dust and mud.

Custom length thread design available

Multifunctional Same cost .

PATENED, M675821, R.O.C

SPAX-12X-LH-C2

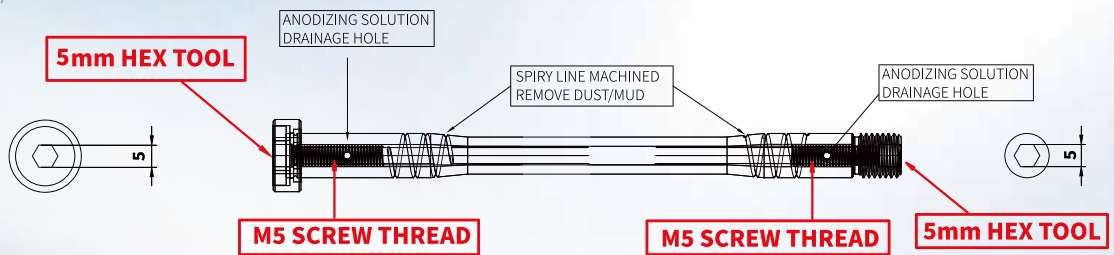

VIDEO



Mr.control

THRU AXLE



THRU AXLE

QUICK RELEASE

SEAT CLAMP

TOP CAP

HEADSETS PARTS

CRANK SET

CHAINRING SYSTEM

ROLLER KIT SERIES

BMX SERIES

CHAINRING PARTS

CHAIN GUIDE SYSTEM

BRAKE SYSTEM

SEATPOST

STEM SYSTEM

HANDLEBAR

AEROBAR SYSTEM

COMPUTER MOUNT

CAGE

ACCESSORIES

FITTING EQUIPMENT

PEDALS

Custom Axle Spec

Standard 100mm Front
Boost 110mm Front
Standard 135/142mm Rear
Boost 148mm Rear
DH150 Rear
Super Boost 157mm Rear

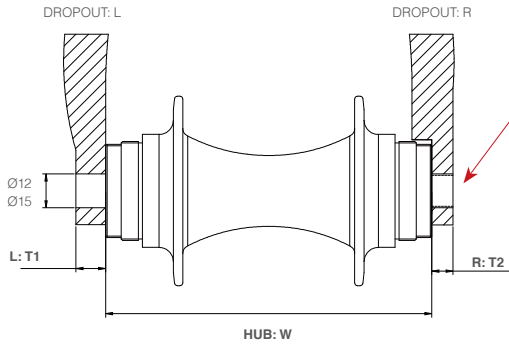

THREAD	
M12 x 1.0	SRAM®
M12 x 1.5	SHIMANO®
M12 x 1.75	SRAM®
M15 x 1.5	SHIMANO®

SPEC	Diameter: T1	HUB:W	Diameter: T2	Thread Nut
FORK	-	-	-	W/I
FRAME	-	-	-	W/I

NEW

SPAX-12X-LH-C2 **PATENED, M675821, R.O.C**

7-01

Thru axle for light holder, with M5 and HEX hole in the L/R side, spiry line machined to remove dust and mud.

MATERIAL: AXLE AL6066-T6

SPEC: Refer to the specification table.

OPTION: THREAD M12X1.0/M12X1.5/M12X1.75

Custom length thread design available.

Axle length	Thread	Thread length
160.8mm	M12*1.5	12mm
165mm-170mm	M12*1.5	15mm
165mm-170mm	M12*1.0	15mm
160mm-165mm	M12*1.5	15mm
160mm-165mm	M12*1.0	15mm
162.5mm	M12*1.5	13mm
165.5mm	M12*1.0	12mm

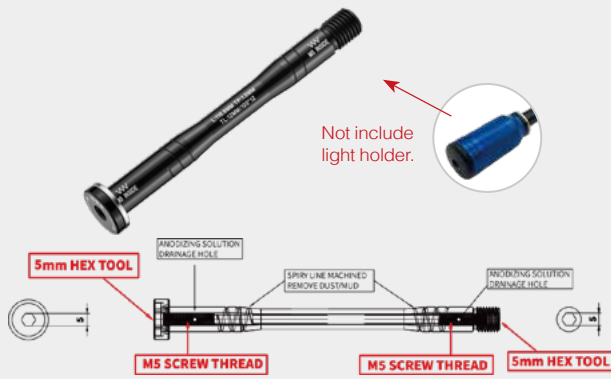

Not include light holder.

SPAX-UA-1-142 (168mm) SPAX-UA-1-148 (176mm)

BEST SELLER

7-02

Thru axle with UDH hanger set.

MATERIAL: Axle / High Strength AL6066-T6

Hanger / High Strength AL6066-T6 / Nylon12+Glass Fiber

Custom length thread design available.



SPAX-12X-M0-C2

BEST SELLER

7-03

MATERIAL: AL6066-T6

SPEC: Refer to the specification table.

OPTION: Thread M12 x 1.0 / M15 x 1.5

Custom length thread design available



12mm axle with CNC cut to save weight and spiry helicoid cut to prevent axle stuck with dust and mud and prevent the axle stuck in the hub.



Allen key design at front head and rear end to make a longer life use.

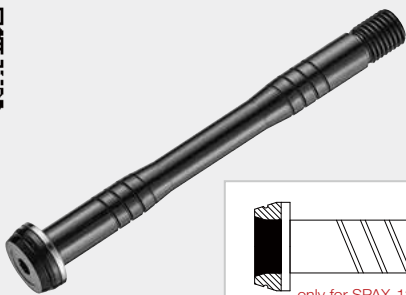

P.A.T. ED World Wide

Customized colors available.



SPAX-M16-12X-C2

BEST SELLER

7-04

MATERIAL: AL6066-T6

SPEC: Refer to the specification table.

OPTION: Thread M12 x 1.0 / M12 x 1.5 / M12 x 1.75

Custom length thread design available

SPAX-121-C2 / SPAX-66-C2

7-05

MATERIAL: AL7075-T6 / AL6066-T6

SPEC: Refer to the specification table.

OPTION: Thread M12 x 1.0 / M15 x 1.5

Custom length thread design available
12mm / 15mm axle custom design available

Specifications are subject to change without notice.

(OPTION: C2)

AXLE TYPE OPTION: C2 type / With light weight / CNC cut design



Custom length thread design available / Refer to the specification table

	Hub	Axle Length	Thread Pitch
MTB	135 SHIMANO®	168	M12 x 1.75 W/l nut
MTB	142 SHIMANO®	171	M12 x 1.5 W/l nut
MTB	148 SHIMANO®	177	M12 x 1.5 W/l nut
MTB	150 SHIMANO®	183	M12 x 1.75 W/l nut

	Hub	Axle Length	Thread Pitch
ROAD	100 SHIMANO®	118	M12 x 1.5 W/O nut
ROAD	142 SHIMANO®	160	M12 x 1.5 W/O nut
MTB	135 SRAM®	167	M12 x 1.75 W/O nut
MTB	142 SRAM®	174	M12 x 1.75 W/O nut
MTB	148 SRAM®	180	M12 x 1.75 W/O nut
MTB	150 SRAM®	182	M12 x 1.75 W/O nut
ROAD	100 SRAM®	125	M15 x 1.5 W/O nut

**SPAX-TL-12X****BEST SELLER**

8-01

Integrated 6mm allen key system with 12mm / 15mm hollow axle, with cover to keep tool in position.

MATERIAL: AL6066-T6 axle

SPEC: Refer to the specification table.

OPTION: Thread M12 x 1.0 / M15 x 1.5

Custom length thread design available

12mm / 15mm axle custom design available

**QR-TAK-12X/15X-C2**

8-02

Step-in System Lever removable. With 4mm allen key for stem bolt / clamp bolt.

MATERIAL OF LEVER: Carbon Injection

MATERIAL OF AXLE: AL6066-T6

SPEC: Refer to the specification table.

OPTION: Thread M12 x 1.0 / M15 x 1.5

Custom length thread design available

**QR-MF18-12X (C2)**

8-03

Light weight design lever / lever can be adjusted from rotational position.

MATERIAL OF LEVER: Carbon Injection

MATERIAL OF AXLE: AL6066-T6

SPEC: Refer to the specification table.

OPTION: Thread M12 x 1.0 / M12 x 1.75

Custom length design available

12mm axle for front fork available



NEW
SPAX-12X-R2RL

9-01

For direct mount hanger protector, protect the dropout from side impacts,strengthens interface between derailleur and frame,with custom length thru axle.

MATERIAL: AL6061-T6
COLOR: Sand blast black
SPEC: Custom length thread design available
Axle length 160.8mm pitch M12*1.5 fit 2023 Giant® TCR/PROPEL/DEFY.



SPAX-12X-R2R

9-02

Protects the dropout from side impacts, strengthens interface between derailleur and frame, with custom length thru axle.

MATERIAL: AL6061-T6
COLOR: Sand blast black
SPEC: Custom length thread design available
Axle length 160.8mm pitch M12*1.5 fit 2023 Giant® TCR & PROPEL & DEFY.



UDH-R2R

9-03

For UDH hanger system,protects the dropout from side impacts,strengthen interface between derailleur and frame.

HANGER MATERIAL: High strength AL 6066-T6
Nylon12+Glass Fiber
PROTECTOR MATERIAL: AL 6061T6
COLOR: Sand blast black
WEIGHT: 66g



UDH-R2R



QR-SPAX-12X (C2)

9-04

For 135mm / 142mm / 148mm / 150mm hub.

MATERIAL: AL7075 axle / Alloy lever
SPEC: Refer to the specification table
OPTION: Thread M12 x 1.0 / M12 x 1.75 with nut
C2 Axle type available
Custom length design available
12mm axle for front fork available



QR-MF5-12X/15X (C2)

9-05

Lever can be adjusted from rotational position.
Max force to 150kg.

MATERIAL: AL6066 axle / AL6061 lever
SPEC: Refer to the specification table.
OPTION: Thread M12 x 1.0 / M15 x 1.5
C2 Axle type available
Custom length design available
12mm axle for front fork available



THRU AXLE

QUICK RELEASE

SEAT CLAMP

TOP CAP

HEADSETS PARTS

CRANK SET

CHAINRING SYSTEM

ROLLER KIT SERIES

BMX SERIES

CHAINRING PARTS

CHAIN GUIDE SYSTEM

BRAKE SYSTEM

SEATPOST

STEM SYSTEM

HANDLEBAR

AEROBAR SYSTEM

COMPUTER MOUNT

CAGE

ACCESSORIES

FITTING EQUIPMENT

PEDALS



Adapter for 9mm fork



Adapter for Ø12mm, width 100mm fork



Adapter for Ø15mm, width 100mm fork



Adapter for Ø15mm, width 110mm fork



BIKE HOLDER-18

10-01

Bike fork mount rack carrier. For normal quick release. Ø12mm width 100mm Ø15mm width 100mm Ø15mm width 110mm



M12x1.75



M12x1.5



M12x1.0



QR-SMW-EX

10-02

Chain washer for thru-axle Ø12mm frame. With 3 size screw adapter easy to adjustment.

MATERIAL: AL6066-T6 Carbon composite / Plastic / AL7075 screw adapter
WEIGHT: 88g/set (With adapter)

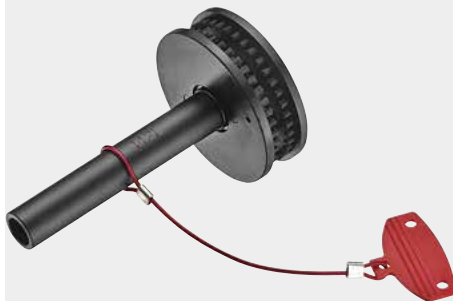

QR-SM-PLW

10-03

Chain washer for thru-axle Ø12mm frame.

MATERIAL: Plastic
WEIGHT: 92g/set (142mm)
SPEC: Width 142 / 148 / 150mm

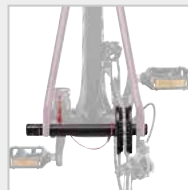

QR-SM-DISC PAD

10-04

Disc pad. For disc caliper.



BEST SELLER

QR-SM-PLR-142E 148E / 150E

11-01

Handy chain tension device for travelling.
For rear Ø12mm thru axle frame.

MATERIAL: Nylon
SPEC: Width 142 / 148 / 150mm
WEIGHT: 46g/pcs (142E)

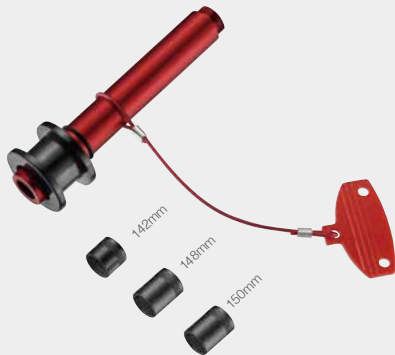

QR-SM-TAR

11-02

For rear Ø12mm thru axle.
Include width adjuster: 142, 148, 150mm.

MATERIAL: AL6061-T6
WEIGHT: 91g/set (with adapter)



QR-SM-TAF012 / TAF015 TAF0151 / TAF020

11-03

For fork Ø12 x 100 thru axle
Ø15 x 100 thru axle
Ø15 x 110 thru axle
Ø20 x 110 thru axle

MATERIAL: AL6061-T6
WEIGHT: 33g/pcs (TAF015)
44g/pcs (TAF020)



QR-SM

11-04

QR-SM-F / 100 with disc pad
QR-SM-R / 135 with roller and disc pad
QR-SM-RC / 130 with roller and disc pad

QUICK RELEASE

SEAT CLAMP

TOP CAP

HEADSETS PARTS

CRANK SET

CHAINRING SYSTEM

ROLLER KIT SERIES

BMX SERIES

CHAINRING PARTS

CHAIN GUIDE SYSTEM

BRAKE SYSTEM

SEATPOST

STEM SYSTEM

HANDLEBAR

AEROBAR SYSTEM

COMPUTER MOUNT

CAGE

ACCESSORIES

FITTING EQUIPMENT

PEDALS



THRU AXLE

QUICK RELEASE

SEAT CLAMP

TOP CAP

HEADSETS PARTS

CRANK SET

CHAINRING SYSTEM

ROLLER KIT SERIES

BMX SERIES

CHAINRING PARTS

CHAIN GUIDE SYSTEM

BRAKE SYSTEM

SEATPOST

STEM SYSTEM

HANDLEBAR

AEROBAR SYSTEM

COMPUTER MOUNT

CAGE

ACCESSORIES

FITTING EQUIPMENT

PEDALS

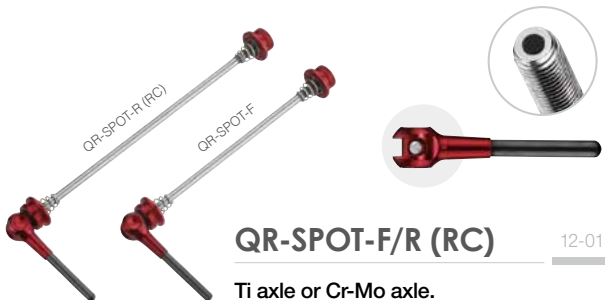
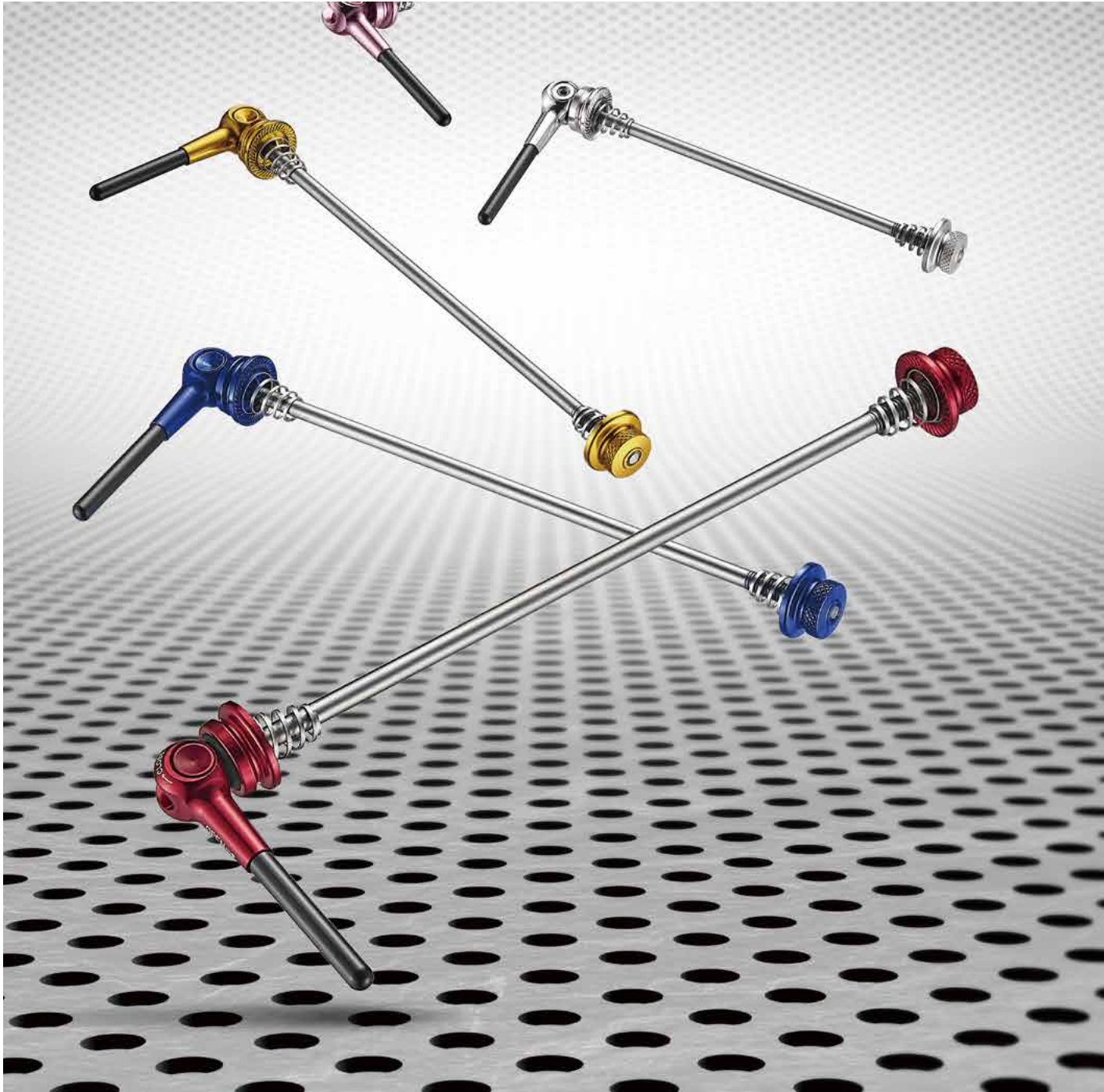

QR-SPOT-F/R (RC)

12-01

Ti axle or Cr-Mo axle.
Alloy and Carbon bonded lever.

WEIGHT: 43g/pair (ROAD) / 46g/pair (MTB)
OPTION: Hollow bolt axle available



QR-K-F/R (RC)

12-02

Ti axle / Alloy lever.

WEIGHT: 53g/pair (ROAD) / 56g/pair (MTB)
OPTION: Cr-Mo axle

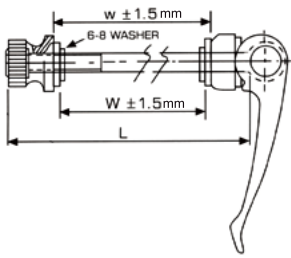

CHART (inmm)

L	PARTS	W	Dia
51	P5+2T	27	8
51	P7+2T	25	8
51	P5	30	6
56	P7+2T	30	8
51	P7	28	6
56	P7+00	33	6
56	P5+00	35	6
136	HUB W:100 / Dropout / t: 4 x 2	108	5
139	HUB W:100 / Dropout / t: 5.5 x 2	111	5
178	HUB W:135 / Dropout / t: 7 x 2	149	5
180	135 / t: 8 x 2	151	5

Double threaded screw PS. 2T= Ø6mm Ø8mm → L-3mm

L	PARTS	W	Dia
68	P5	35	6
68	P7	33	6
60	P5	28	6
Hub QR	L-39	W	5
150/F	Hub w:100 / t: 5.5 x 2	111	5
153/F	Hub w:100 / t: 7 x 2	114	5
181/RC	Hub w:130 / t: 7 x 2	144	5
188/R	Hub w:135 / t: 7 x 2	149	5
192/R	Hub w:135 / t: 9 x 2	153	5

QR-SPOC-F/R (RC) 13-01

Ti axle or Cr-Mo axle / Alloy lever.

WEIGHT: 45g/pair (ROAD) / 47g/pair (MTB)
OPTION: Hollow bolt axle available
 QR-SPOC-F / 100 for front
 QR-SPOC-R / 135 for MTB rear
 QR-SPOC-RC / 130 for Road bike rear

QR-SPL-F/R (RC) 13-02

Cr-Mo axle / Alloy lever.

WEIGHT: 71g/pair (ROAD) / 75g/pair (MTB)
OPTION: Ti axle
 QR-SPL-F / 100 for front
 QR-SPL-R / 135 for MTB rear
 QR-SPL-RC / 130 for Road bike rear

QR-KM2H-M52 13-03

Cr-Mo axle.

QR-KM2H-M52F / 100 for front
 QR-KM2H-M52R / 135 for MTB rear
 QR-KM2H-M52RC / 130 for Road bike rear

QR-KE06H-M54 13-04

New style for economy quick release. AL6061-T6 / Cr-Mo axle.

WEIGHT: 115g/pair (ROAD) / 118g/pair (MTB)
 QR-KE06H-M54S / for seattube
 QR-KE06H-M54F / 100 for front
 QR-KE06H-M54R / 135 for MTB rear
 QR-KE06H-M54RC / 130 for Road bike rear

QR-KE06E 13-05

BEST SELLER

New style for economy quick release. AL6061-T6 / Steel axle.

WEIGHT:
 121g/pair (ROAD) / 124g/pair (MTB)
 QR-KE06E-SE / for seattube
 QR-KE06E-EF / 100 for front
 QR-KE06E-ER / 135 for MTB rear
 QR-KE06E-ERC / 130 for Road bike rear

NEW **QR-SPL-LHF** 13-06

QR axle with light holder for hollow front thru axle system.

MATERIAL: AL6061-T6
AXLE: Cr-Mo axle
COLOR: AS ORDER
 Custom length thread design available.



THRU AXLE

QUICK RELEASE

SEAT CLAMP

TOP CAP

HEADSETS PARTS

CRANK SET

CHAINRING SYSTEM

ROLLER KIT SERIES

BMX SERIES

CHAINRING PARTS

CHAIN GUIDE SYSTEM

BRAKE SYSTEM

SEATPOST

STEM SYSTEM

HANDLEBAR

AEROBAR SYSTEM

COMPUTER MOUNT

CAGE

ACCESSORIES

FITTING EQUIPMENT

PEDALS

THRU AXLE

QUICK RELEASE

SEAT CLAMP

TOP CAP

HEADSETS PARTS

CRANK SET

CHAINRING SYSTEM

ROLLER KIT SERIES

BMX SERIES

CHAINRING PARTS

CHAIN GUIDE SYSTEM

BRAKE SYSTEM

SEATPOST

STEM SYSTEM

HANDLEBAR

AEROBAR SYSTEM

COMPUTER MOUNT

CAGE

ACCESSORIES

FITTING EQUIPMENT

PEDALS

QR-KM2

14-01

QR-KM2-SE for seattube
QR-KM2-EF / 100 for front
QR-KM2-ER / 135 for MTB rear
QR-KM2-ERC / 130 for Road bike rear

QR-KM1

14-02

QR-KM1-SE for seattube
QR-KM1-EF / 100 for front
QR-KM1-ER / 135 for MTB rear
QR-KM1-ERC / 130 for Road bike rear

QR-11-E

14-03

BEST SELLER

With plastic nut + steel.

QR-11-SE for seattube
QR-11-EF / 100 for front
QR-11-ER / 135 for MTB rear
QR-11-ERC / 130 for Road bike rear

QR-11-H

14-04

With alloy nut.

QR-11-SH for seattube
QR-11-HF / 100 for front
QR-11-HR / 135 for MTB rear
QR-11-HRC / 130 for Road bike rear

QR-KM2-SE

14-05

For seattube.
Cr-Mo axle.
AL6061-T6 lever.

QR-XL

14-06

For seattube.
Cr-Mo axle.
AL6061-T6 lever.

90mm

QR-112H2

14-07

For seattube.
Cr-Mo axle.
AL6061-T6 lever.

Our quick release levers come with various lengths. Besides the regular length (65mm), we also provide the following length for your reference: 65mm, 72mm and 90mm.



THRU AXLE

QUICK RELEASE

SEAT CLAMP

TOP CAP

HEADSETS PARTS

CRANK SET

CHAINING SYSTEM

ROLLER KIT SERIES

BMX SERIES

CHAINING PARTS

CHAIN GUIDE SYSTEM

BRAKE SYSTEM

SEATPOST

STEM SYSTEM

HANDLEBAR

AEROBAR SYSTEM

COMPUTER MOUNT

CAGE

ACCESSORIES

FITTING EQUIPMENT

PEDALS



QR-72E BEST SELLER 15-01

Cr-Mo axle / Alloy lever.

WEIGHT: 125g/pair (ROAD)
126.5g/pair (MTB) / 41.5g/pcs (S)
QR-72E-S / for seattube
QR-72E-F / 100 for front
QR-72E-R / 135 for MTB rear
QR-72E-RC / 130 for Road bike rear

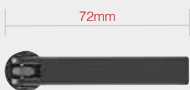

QR-72M 15-02

Cr-Mo axle / With longer lever (72mm).

WEIGHT: 100g/pair (ROAD)
103g/pair (MTB) / 39g/pcs (S)
QR-72M-S for seattube
QR-72M-F / 100 for front
QR-72M-R / 135 for MTB rear
QR-72M-RC / 130 for Road bike rear



normal 60mm



QR-72H 15-03

Cr-Mo axle / With longer lever (72mm).

WEIGHT: 123g/pair (ROAD)
125g/pair (MTB) / 44g/pcs (S)
QR-72H-S for seattube
QR-72H-F / 100 for front
QR-72H-R / 135 for MTB rear
QR-72H-RC / 130 for Road bike rear



normal 60mm

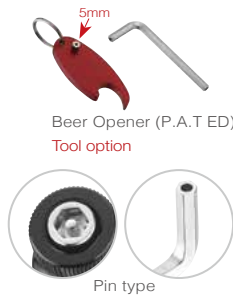

SP-56 15-04

With special allen key to lock & release.

SP-56-F / 100 for front
SP-56-R / 135 for MTB rear
SP-56-RC / 130 for Road bike rear
TOOL OPTION: Key ring



SP-56H 15-05

With special allen key to lock & release.
Hollow bolt (for F & R axle) & Carbon reinforce.

SP-56-SH for seattube
SP-56-HF / 100 for front
SP-56-HR / 135 for MTB rear
SP-56-HRC / 130 for Road bike rear



SP-66 15-06

For seattube.
Cr-Mo axle.

MATERIAL: AL6061-T6

BOLT	W	BOLT	W
40	24	55	39
45	29	60	44
50	34		



CL-AH2 15-07

For seattube.

MATERIAL: Steel heat treatment CNC finished
W: 19mm / 22mm / 25mm / 27mm
CL-AH2-001 with anti-pin
CL-AH2-002 with knurl

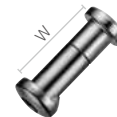

CL-AH 15-08

For seattube.

MATERIAL: Steel heat treatment
W: 19mm / 22mm / 25mm / 27mm



THRU AXLE

QUICK
RELEASE

SEAT CLAMP

TOP CAP

HEADSETS
PARTS

CRANK SET

CHAINRING
SYSTEM

ROLLER KIT
SERIES

BMX SERIES

CHAINRING
PARTS

CHAIN GUIDE
SYSTEM

BRAKE SYSTEM

SEATPOST

STEM SYSTEM

HANDLEBAR

AEROBAR
SYSTEM

COMPUTER
MOUNT

CAGE

ACCESSORIES

FITTING
EQUIPMENT

PEDALS





THRU AXLE

QUICK RELEASE

SEAT CLAMP

TOP CAP

HEADSETS PARTS

CRANK SET

CHAINRING SYSTEM

ROLLER KIT SERIES

BMX SERIES

CHAINRING PARTS

CHAIN GUIDE SYSTEM

BRAKE SYSTEM

SEATPOST

STEM SYSTEM

HANDLEBAR

AEROBAR SYSTEM

COMPUTER MOUNT

CAGE

ACCESSORIES

FITTING EQUIPMENT

PEDALS



OVER SIZE **BEST SELLER**

CL-CV

17-01



P.A.T.ED WORLD WIDE

Extend rubber cover, to prevent dust permeate in to seattube.
Chamfer edge & oval hole design to protect carbon frame & seatpost.

MATERIAL: AL6061-T6 clamp with NBR cover

SPEC: Ø27.2 seatpost - Ø31.8 seattube / Ø31.6 seatpost - Ø34.9 seattube
Ø27.2 seatpost - Ø34.9 seattube / Ø30.9 seatpost - Ø34.9 seattube
Ø33.9 seatpost - Ø38.1 seattube / Ø34.9 seatpost - Ø38.6 seattube
H: 16mm (12mm insert)

COLOR: Clamp: Black anodize

Cover: Black, Red, Blue, Apple Green, Orange, Pink, White, Yellow

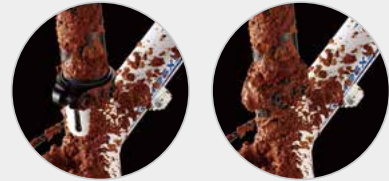

OVER SIZE **BEST SELLER**

CL-FJ21

17-02



MATERIAL: AL6066 CNC made
SPEC: Ø28.6, Ø31.8, Ø34.9, Ø38.6
H: 14mm
COLOR: As Order
STANDARD: Blast anodize
OPTION: H 16.5mm
Oval hole design for carbon fiber



OVER SIZE **BEST SELLER**

CL-FJ21-2

17-03

MATERIAL: AL6066 CNC made
SPEC: Ø28.6, Ø31.8, Ø34.9, Ø38.6
H: 14mm
COLOR: As Order
STANDARD: Blast anodize
OPTION: H 16.5mm
Oval hole design for carbon fiber

OVER SIZE **BEST SELLER**

CL-FJ21-1

17-04



MATERIAL: AL6066 CNC made
SPEC: Ø28.6, Ø31.8, Ø34.9, Ø38.6
H: 14mm
COLOR: As Order
STANDARD: Blast anodize
OPTION: H 16.5mm
Oval hole design for carbon fiber



OVER SIZE **BEST SELLER**

CL-07-2X

17-05

MATERIAL: AL6061 CNC made
Two M5 x 20mm bolt
SPEC: Ø28.6, Ø31.8, Ø34.9, Ø38.1, Ø38.6
H: 20mm
COLOR: As Order
Special chamfer for carbon frame

CL-07GB-CO 17-06

Seat clamp with cover.



MATERIAL: AL6061 CNC made
SPEC: Ø27.2 seatpost - Ø31.8 seattube
Ø31.6 seatpost - Ø34.9 seattube
H: 17.5mm (13mm insert)
COLOR: As Order / Black cover
Oval hole design for carbon fiber

CL-07FB2-CO 17-07

Seat clamp with cover.



MATERIAL: AL6061 CNC made
SPEC: Ø27.2 seatpost - Ø31.8 seattube
Ø31.6 seatpost - Ø34.9 seattube
H: 18.5mm (14mm insert)
COLOR: As Order / Black cover
Oval hole design for carbon fiber
Special chamfer for carbon frame

CL-07JB1-CO 17-08

Seat clamp with cover.



MATERIAL: AL6061 CNC made
SPEC: Ø27.2 seatpost - Ø31.8 seattube
Ø31.6 seatpost - Ø34.9 seattube
H: 17mm (13mm insert)
COLOR: As Order / Black cover
Oval hole design for carbon fiber
Special chamfer for carbon frame

SEAT CLAMP

THRU AXLE

QUICK RELEASE

SEAT CLAMP

TOP CAP

HEADSETS PARTS

CRANK SET

CHAINRING SYSTEM

ROLLER KIT SERIES

BMX SERIES

CHAINRING PARTS

CHAIN GUIDE SYSTEM

BRAKE SYSTEM

SEATPOST

STEM SYSTEM

HANDLEBAR

AEROBAR SYSTEM

COMPUTER MOUNT

CAGE

ACCESSORIES

FITTING EQUIPMENT

PEDALS



OVER SIZE
CL-07 **BEST SELLER** 18-01

MATERIAL: AL6061 CNC made
SPEC: Ø25.4, Ø28.6, Ø31.8, Ø34.9, **Ø38.1, Ø38.6**
H: 15mm
COLOR: As Order
WEIGHT: 22.5g



OVER SIZE **BEST SELLER**
CL-07-P / CL-07-P-2 18-02

MATERIAL: AL6061 CNC made
SPEC: Ø25.4, Ø28.6, Ø31.8, Ø34.9, **Ø38.1, Ø38.6**
H: 15mm
COLOR: As Order
WEIGHT: 22.5g
OPTION: Oval hole for carbon
CL-07-P-2: Two tone
Special chamfer for carbon frame



CL-AD-A1 18-03

MATERIAL: AL6061 CNC made
SPEC: Ø28.6, Ø31.8, Ø34.9
H: 15mm
COLOR: As Order
STANDARD: Blast anodize



OVER SIZE
CL-H2C 18-04

MATERIAL: AL6066 CNC made
SPEC: Ø31.8, Ø34.9, **Ø36, Ø37, Ø38.1**
H: 14mm
COLOR: As Order
STANDARD: Blast anodize
OPTION: Ø28.6, Ø29.8, Ø30.0, **Ø40.0**
(price different)
Oval hole design for carbon fiber



CL-55GB 18-05

MATERIAL: AL6061
SPEC: Ø31.8, Ø34.9
H: 10.5mm
COLOR: As Order
STANDARD: Blast anodize



OVER SIZE
CL-H2C-2 18-06

MATERIAL: AL6066 CNC made
SPEC: Ø31.8, Ø34.9, **Ø36, Ø37, Ø38.1**
H: 14mm
COLOR: As Order
STANDARD: Blast anodize
OPTION: Ø28.6, Ø29.8, Ø30.0, **Ø40.0**
(price different)
Oval hole design for carbon fiber



CL-02K 18-07

MATERIAL: AL6061
SPEC: Ø25.4, Ø28.6, Ø31.8, Ø34.9
H: 11mm
COLOR: As Order



CL-02P / CL-02P-2 18-08

MATERIAL: AL6061
SPEC: Ø25.4, Ø28.6, Ø31.8, Ø34.9
H: 11mm
COLOR: As Order
CL-02P-2: Two tone



THRU AXLE

QUICK
RELEASE

SEAT CLAMP

TOP CAP

HEADSETS
PARTS

CRANK SET

CHAINRING
SYSTEMROLLER KIT
SERIES

BMX SERIES

CHAINRING
PARTSCHAIN GUIDE
SYSTEM

BRAKE SYSTEM

SEATPOST

STEM SYSTEM

HANDLEBAR

AEROBAR
SYSTEMCOMPUTER
MOUNT

CAGE

ACCESSORIES

FITTING
EQUIPMENT

PEDALS

**OVER SIZE****CL-03GB**

19-01

MATERIAL: AL6061
SPEC: Ø25.4, Ø28.6, Ø31.8, Ø34.9,
Ø37, Ø38.1
H: 15mm
COLOR: As Order

**CL-02GB**

19-02

MATERIAL: AL6061
SPEC: Ø25.4, Ø28.6, Ø31.8, Ø34.9
H: 11mm
COLOR: As Order

**CL-02JB**

19-03

MATERIAL: AL6061
SPEC: Ø25.4, Ø28.6, Ø31.8, Ø34.9
H: 11mm
COLOR: As Order

**CL-05-15D**

19-04

MATERIAL: AL6061 CNC made
SPEC: Dia As Order
H: 15mm
COLOR: As Order
OPTION: Oval hole for carbon
Special chamfer for carbon frame

**CL-033K**

19-05

MATERIAL: AL6061
SPEC: Ø25.4, Ø28.6, Ø31.8, Ø34.9
H: 15mm
COLOR: Blast anodize

**CL-J5B**

19-06

MATERIAL: AL6061
SPEC: Ø25.4, Ø28.6, Ø31.8, Ø34.9
H: 13.5mm
COLOR: As Order

**CL-94B**

19-07

MATERIAL: AL6061
SPEC: Ø25.4, Ø28.6, Ø31.8, Ø34.9
H: 11mm
COLOR: As Order

**CL-STEM**

19-08

MATERIAL: AL6061
SPEC: Ø28.6
H: 10mm
COLOR: Blast black anodize





THRU AXLE

QUICK
RELEASE

SEAT CLAMP

TOP CAP

HEADSETS
PARTS

CRANK SET

CHAINRING
SYSTEMROLLER KIT
SERIES

BMX SERIES

CHAINRING
PARTSCHAIN GUIDE
SYSTEM

BRAKE SYSTEM

SEATPOST

STEM SYSTEM

HANDLEBAR

AEROBAR
SYSTEMCOMPUTER
MOUNT

CAGE

ACCESSORIES

FITTING
EQUIPMENT

PEDALS



Ø34.9 model

CL-FDG3

20-01

For front derailleur, brazed on style clamp.
Additional stopper for front derailleur screw.

MATERIAL: AL6061
SPEC: Ø28.6, Ø31.8, Ø34.9mm
COLOR: As Order



Additional stopper



Big shape for frame Ø34.9

**CL-EFD-33**

20-02

For E-Bike front derailleur.
Brazed on style clamp.
Additional stopper for front derailleur screw.

MATERIAL: AL6061
SPEC: Ø31.8, Ø34.9mm
COLOR: As Order
WEIGHT: 30g

**CL-FDG2-9**

20-03

For front derailleur.

MATERIAL: AL6061
SPEC: Ø31.8, Ø34.9
9°+ 20mm offset
COLOR: As Order

**CL-FD**

20-04

For front derailleur.

MATERIAL: AL6061
SPEC: Ø28.6, Ø31.8, Ø34.9
COLOR: As Order

**CL-FDM**

20-05

Cold forged, for front derailleur.

MATERIAL: AL6061
SPEC: Ø31.8, Ø34.9
COLOR: As Order

**CL-CX**

20-06

Canti brake cable hanger.

MATERIAL: AL6061
SPEC: Ø31.8, Ø34.9
H: 16mm
COLOR: As Order
STANDARD: Blast anodize

**CL-50**

20-07

Replaceable for SHIMANO®.
E-type front derailleur's seattube eyelet.

MATERIAL: AL6061
SPEC: Ø28.6, Ø31.8, Ø34.9
H: 10mm
COLOR: As Order



M5 Thread for carrier

CL-FR**BEST SELLER**

20-08

MATERIAL: AL6061
SPEC: Ø28.6, Ø29.8, Ø31.8, Ø34.9
H: 13.5mm
COLOR: As Order
STANDARD: Blast anodize

Customize seatpost
clamp available**CL-5085V**

20-09

For converting frames with top mounted cable to traditional bottom pull front derailleurs.

MATERIAL: AL6061
SPEC: Ø28.6, Ø31.8, Ø34.9
H: 10mm
COLOR: As Order



THRU AXLE

QUICK RELEASE

SEAT CLAMP

TOP CAP

HEADSETS PARTS

CRANK SET

CHAINRING SYSTEM

ROLLER KIT SERIES

BMX SERIES

CHAINRING PARTS

CHAIN GUIDE SYSTEM

BRAKE SYSTEM

SEATPOST

STEM SYSTEM

HANDLEBAR

AEROBAR SYSTEM

COMPUTER MOUNT

CAGE

ACCESSORIES

FITTING EQUIPMENT

PEDALS

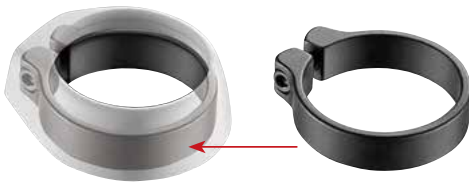

CL-STOPPER-CO / CL-STOPPER

21-01

To prevent the drop caused by the tolerance between seatpost & clamp & seattube. Also can be height marker with rubber cover to prevent dust can fix any type of clamp.

MATERIAL: AL6061-T6 clamp / Rubber cover

SPEC: Ø27.2, Ø30.9, Ø31.6

COLOR: Clamp: Blast black anodize

Cover: Black, Red, Blue, Apple Green, Orange, Pink, White, Yellow



CL-A1K

21-02

MATERIAL: AL6061
SPEC: Ø31.8, Ø34.9
H: 14mm
COLOR: As Order



CL-51

21-03

Clamp with cable stop.

MATERIAL: AL6061
SPEC: Ø31.8, Ø34.9
H: 12mm
COLOR: As Order



CL-A1

21-04

MATERIAL: AL6061
SPEC: Ø28.6, Ø31.8, Ø34.9
H: 14mm
COLOR: As Order



CL-95SUB-A14

21-05

MATERIAL: AL6061 CNC made
SPEC: Ø31.8, Ø34.9
H: 16mm
COLOR: As Order



OVER SIZE CL-030

21-06

MATERIAL: AL6061
SPEC: Ø25.4, Ø28.6, Ø31.8, Ø34.9,
Ø37, Ø38.1
H: 13.5mm
COLOR: As Order



OVER SIZE CL-95B

21-07

MATERIAL: AL6061
SPEC: Ø25.4, Ø28.6, Ø31.8, Ø34.9,
Ø37, Ø38.1, Ø38.6
H: 13.5mm
COLOR: As Order





THRU AXLE

QUICK
RELEASE

SEAT CLAMP

TOP CAP

HEADSETS
PARTS

CRANK SET

CHAINRING
SYSTEMROLLER KIT
SERIES

BMX SERIES

CHAINRING
PARTSCHAIN GUIDE
SYSTEM

BRAKE SYSTEM

SEATPOST

STEM SYSTEM

HANDLEBAR

AEROBAR
SYSTEMCOMPUTER
MOUNT

CAGE

ACCESSORIES

FITTING
EQUIPMENT

PEDALS

**OVER SIZE**
CL-951B

22-01

MATERIAL: AL6061
SPEC: Ø25.4, Ø28.6, Ø31.8, Ø34.9,
Ø37, Ø38.1, Ø38.6
H: 13.5mm
COLOR: As Order

**OVER SIZE**
CL-96B

22-02

MATERIAL: AL6061
SPEC: Ø28.6, Ø31.8, Ø34.9,
Ø37, Ø38.1
H: 13.5mm
COLOR: As Order

**OVER SIZE**
CL-97B

22-03

MATERIAL: AL6061
SPEC: Ø28.6, Ø31.8, Ø34.9,
Ø37, Ø38.1
H: 13.5mm
COLOR: As Order

**CL-97GB**

22-04

MATERIAL: AL6061
SPEC: Ø28.6, Ø31.8, Ø34.9
H: 15mm
COLOR: As Order

**OVER SIZE**
CL-93B-O

22-05

For BMX or Fixed gear.

MATERIAL: AL6061
SPEC: Ø25.4, Ø28.6, Ø31.8, Ø34.9,
Ø37, Ø38.1
H: 35mm
COLOR: As Order
Internal holes throughout

**OVER SIZE**
CL-93JB

22-06

MATERIAL: AL6061
SPEC: Ø25.4, Ø28.6, Ø31.8, Ø34.9,
Ø37, Ø38.1
H: 35mm
COLOR: As Order

**OVER SIZE**
CL-93JB-O

22-07

MATERIAL: AL6061
SPEC: Ø25.4, Ø28.6, Ø31.8, Ø34.9,
Ø37, Ø38.1
H: 35mm
COLOR: As Order
Internal holes throughout

**OVER SIZE**
CL-93B

22-08

MATERIAL: AL6061
SPEC: Ø25.4, Ø28.6, Ø31.8, Ø34.9,
Ø37, Ø38.1
H: 35mm
COLOR: As Order

**CL-93JB-2-70L-O**

22-09

For BMX or Fixed gear.

MATERIAL: AL6061
SPEC: Ø33.3, Ø34.9
H: 70mm
COLOR: As Order
Internal holes throughout

**CL-73B**

22-10

MATERIAL: AL6061
SPEC: Ø25.4, Ø28.6
H: 35mm
COLOR: As Order



THRU AXLE

QUICK RELEASE

SEAT CLAMP

TOP CAP

HEADSETS PARTS

CRANK SET

CHAINRING SYSTEM

ROLLER KIT SERIES

BMX SERIES

CHAINRING PARTS

CHAIN GUIDE SYSTEM

BRAKE SYSTEM

SEATPOST

STEM SYSTEM

HANDLEBAR

AEROBAR SYSTEM

COMPUTER MOUNT

CAGE

ACCESSORIES

FITTING EQUIPMENT

PEDALS

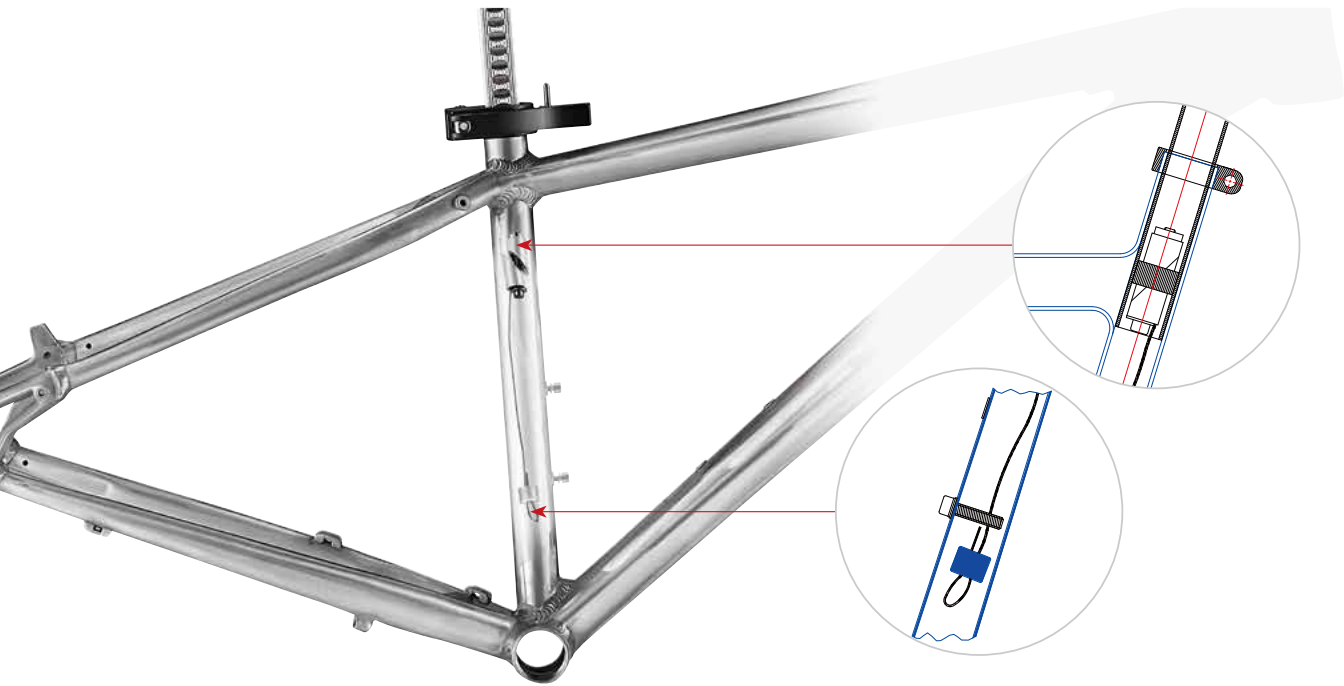

S/SAFE

23-01

Comes with one long bottle cage screw and two seatpost adapters.

MATERIAL: AL6061-T6

The easy-to-use S/SAFE pin secures your seatpost from stolen. Install the S/SAFE pin inside the seatpost. Then, screw tight the provided bottle cage screw. The long screw thus jams the passage of the S/SAFE pin, preventing the seatpost from pulled up.

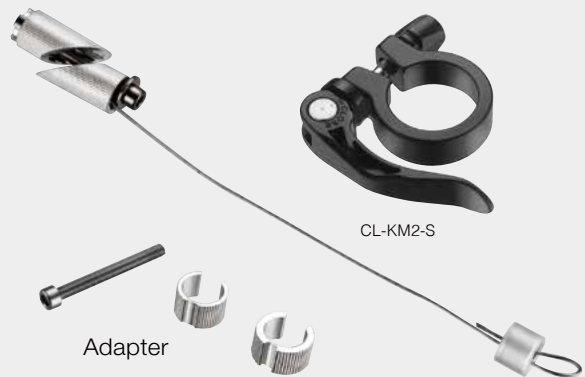

CL-KE06E-CV

23-02

Seat clamp with anti-dust cover.

MATERIAL: AL6061

SPEC: Ø27.2 seatpost - Ø31.8 seattube
Ø31.6 seatpost - Ø34.9 seattube

H: 20mm (15mm insert)

COLOR: As Order / Black cover

P.A.T ED



THRU AXLE

QUICK RELEASE

SEAT CLAMP

TOP CAP

HEADSETS PARTS

CRANK SET

CHAINRING SYSTEM

ROLLER KIT SERIES

BMX SERIES

CHAINRING PARTS

CHAIN GUIDE SYSTEM

BRAKE SYSTEM

SEATPOST

STEM SYSTEM

HANDLEBAR

AEROBAR SYSTEM

COMPUTER MOUNT

CAGE

ACCESSORIES

FITTING EQUIPMENT

PEDALS



CL-KE06-QT 24-01

MATERIAL: AL6061
SPEC: Ø28.6, Ø31.8, Ø34.9
H: 13.5mm
COLOR: As Order





BEST SELLER



CL-KM2-IT 24-02

MATERIAL: AL6061
SPEC: Ø28.6, Ø31.8, Ø34.9
H: 16mm
COLOR: As Order
STANDARD: Blast anodize





CL-98XL 24-04

MATERIAL: AL6061
SPEC: Ø28.6, Ø31.8mm
H: 13.5mm
COLOR: As Order



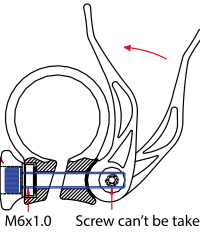

Turn the nut to lock

M6x1.0 Screw can't be taken out



CL-KM2-IT-S 24-03

With special bolt and nut to lock.

MATERIAL: AL6061
SPEC: Ø28.6, Ø31.8, Ø34.9
H: 16mm
COLOR: As Order
STANDARD: Blast anodize
P.A.T ED



CL-E21-QT 24-05

MATERIAL: AL6061
SPEC: Ø28.6, Ø31.8
H: 13.5mm
COLOR: As Order
P.A.T ED



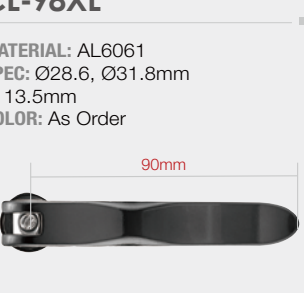

CL-98XL 24-04

MATERIAL: AL6061
SPEC: Ø28.6, Ø31.8mm
H: 13.5mm
COLOR: As Order

90mm





CL-KM2 24-06

Cold forged.

SPEC: Ø25.4, Ø28.6, Ø31.8, Ø34.9
H: 13.5mm
COLOR: As Order
STANDARD: Blast anodize





CL-KM2-S 24-07

With special bolt and nut to lock.

MATERIAL: AL6061
SPEC: Ø28.6, Ø31.8, Ø34.9
H: 13.5mm
COLOR: As Order
STANDARD: Blast anodize
P.A.T ED





THRU AXLE

QUICK RELEASE

SEAT CLAMP

TOP CAP

HEADSETS PARTS

CRANK SET

CHAINRING SYSTEM

ROLLER KIT SERIES

BMX SERIES

CHAINRING PARTS

CHAIN GUIDE SYSTEM

BRAKE SYSTEM

SEATPOST

STEM SYSTEM

HANDLEBAR

AEROBAR SYSTEM

COMPUTER MOUNT

CAGE

ACCESSORIES

FITTING EQUIPMENT

PEDALS





OVER SIZE
CL-9872HJ-QT 25-01

MATERIAL: AL6061
With longer lever (72mm)
SPEC: Ø28.6, Ø31.8, Ø34.9, Ø38.6
H: 13mm
COLOR: As Order



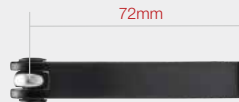

OVER SIZE **BEST SELLER**
CL-9872E-QT 25-02

MATERIAL: AL6061
With longer lever (72mm)
SPEC: Ø28.6, Ø31.8, Ø34.9, Ø38.6, Ø40
H: 13mm
COLOR: As Order

OVER SIZE **BEST SELLER**
CL-96QT 25-03

MATERIAL: AL6061
SPEC: Ø25.4, Ø28.6, Ø31.8, Ø34.9, Ø37.0, Ø38.1, Ø38.6, Ø40
H: 13mm
COLOR: As Order





CL-98QT **BEST SELLER** 25-04

MATERIAL: AL6061
SPEC: Ø25.4, Ø28.6, Ø31.8, Ø34.9
H: 13mm
COLOR: As Order





OVER SIZE
CL-9872MJ-QT 25-05

MATERIAL: AL6061
With longer lever (72mm)
SPEC: Ø28.6, Ø31.8, Ø34.9, Ø38.6
H: 13mm
COLOR: As Order

CL-KM1 25-06

SPEC: Ø25.4, Ø28.6, Ø31.8, Ø34.9
H: 13.5 mm
COLOR: As Order
STANDARD: Blast anodize



CL-KM1-J 25-07

SPEC: Ø25.4, Ø28.6, Ø31.8, Ø34.9
H: 13.5 mm
COLOR: As Order
STANDARD: Blast anodize

CL-KM1-J2 25-08

SPEC: Ø25.4, Ø28.6, Ø31.8, Ø34.9
H: 13.5 mm
COLOR: As Order
STANDARD: Blast anodize



Our quick release levers come with various lengths. Besides the regular length (65mm), we also provide the following length for your reference: 65mm, 72mm and 90mm.





THRU AXLE

QUICK RELEASE

SEAT CLAMP

TOP CAP

HEADSETS PARTS

CRANK SET

CHAINRING SYSTEM

ROLLER KIT SERIES

BMX SERIES

CHAINRING PARTS

CHAIN GUIDE SYSTEM

BRAKE SYSTEM

SEATPOST

STEM SYSTEM

HANDLEBAR

AEROBAR SYSTEM

COMPUTER MOUNT

CAGE

ACCESSORIES

FITTING EQUIPMENT

PEDALS



Screw weight information

M6x1.0x30L (5mm Allen key)	STEEL BOLT	STAINLESS BOLT	AL7075 BOLT
Weight	7.8g	7.8g	2.8g



TK-MG-CO

26-01

Top cap with full cover.

MATERIAL: AL6061-T6

COLOR: As order

WEIGHT: 9g

Custom logo design available



**TK-001S-Y01
TK-001S-Y02
TK-001S-Y03**

26-02

MATERIAL: AL6061-T6 CNC made

WEIGHT: 15g/pcs (W/O star nut)

SIZE: 1-1/8"

STANDARD: Blast anodize with star nut

OPTION: AL7075-T73 screw

Stainless screw

TK-001S-Y01

TK-001S-Y02

TK-001S-Y03



THRU AXLE

QUICK RELEASE

SEAT CLAMP

TOP CAP

HEADSETS PARTS

CRANK SET

CHAINRING SYSTEM

ROLLER KIT SERIES

BMX SERIES

CHAINRING PARTS

CHAIN GUIDE SYSTEM

BRAKE SYSTEM

SEATPOST

STEM SYSTEM

HANDLEBAR

AEROBAR SYSTEM

COMPUTER MOUNT

CAGE

ACCESSORIES

FITTING EQUIPMENT

PEDALS



TK-001S
TK-001S-38.1

BEST SELLER

27-01

MATERIAL: AL6061-T6
WEIGHT: 17.5g/pcs (W/O star nut)
SIZE: 1", 1-1/8" or 1-1/2"
COLOR: Blue
OPTION: 1. Stainless screw
2. Star nut



TK-BEERA

27-02

With TK-001S
MATERIAL: AL6061-T6 CNC finished
WEIGHT: 23g (W/O star nut)
SIZE: 1-1/8"



TK-TD-C

27-03

MATERIAL: Carbon
WEIGHT: 11.5g/pcs (W/O star nut)
SIZE: 1-1/8"
With star nut



TK-TD18

BEST SELLER

27-04

MATERIAL: AL6061-T6
WEIGHT: 13.3g/pcs (W/O star nut)
SIZE: 1-1/8"
COLOR: Sand blast anodize with star nut
OPTION: AL7075-T73 screw

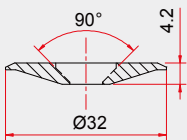

TK-TD12-E

27-05

MATERIAL: AL6061-T6
WEIGHT: 16.5g/pcs (W/O star nut)
SIZE: 1-1/8"
COLOR: Sand blast anodize
Stainless screw
OPTION: AL7075-T73 screw

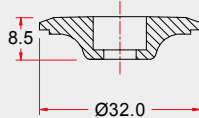

TK-TD01

27-06

MATERIAL: AL6061-T6
WEIGHT: 13g/pcs (W/O star nut)
SIZE: 1-1/8"
COLOR: Sand blast anodize with star nut
OPTION: AL7075-T73 screw
Stainless screw

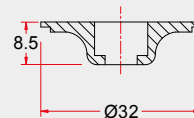

TK-T032A

27-07

For Ø31.8 Fork.
With stainless steel bolt.

MATERIAL: AL6061-T6
STANDARD: Blast anodize with star nut
WEIGHT: 11.2g/pcs (W/O star nut)



TK-001D

27-08

MATERIAL: AL6061-T6
WEIGHT: 14.5g/pcs (W/O star nut)
SIZE: 1", 1-1/8"
OPTION: 1. Stainless screw
2. Star nut



TK-SC-12AP

27-09

MATERIAL: AL6061-T6
cold forged made
WEIGHT: 9.8g/pcs (W/O star nut)
SIZE: 1-1/8"
With star nut



STAR NUT-29

27-10

For Ø31.8 Alloy / Cr-Mo fork.

SPEC: Ø28.8
WEIGHT: 10.5g/pcs



NEW

STAR NUT-030

27-11

For internal routing of front brake hose and front electrical cable.

SPEC: 1-1/8 steere tube.
WEIGHT: 9.5g



THRU AXLE

QUICK RELEASE

SEAT CLAMP

TOP CAP

HEADSETS PARTS

CRANK SET

CHAINRING SYSTEM

ROLLER KIT SERIES

BMX SERIES

CHAINRING PARTS

CHAIN GUIDE SYSTEM

BRAKE SYSTEM

SEATPOST

STEM SYSTEM

HANDLEBAR

AEROBAR SYSTEM

COMPUTER MOUNT

CAGE

ACCESSORIES

FITTING EQUIPMENT

PEDALS

**Reliable fork expander plugs make the fork design safer and better.
Custom design available.**

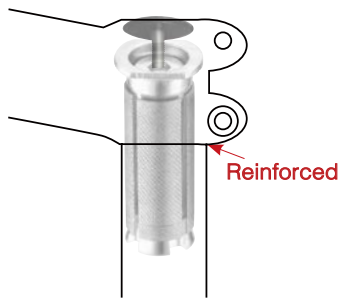

Suggestion With TK-001D



P.A.T ED
Reinforced
Carbon
Stem Tube

(Old No: TK012WS-CAL will update to this item)

TK-012SW **BEST SELLER** 28-01

For Ø28.6 Carbon fork, inner tube expander.

SPEC: Ø22.0 - Ø23.4 without shim
Ø23.4 - Ø25.0 with shim

H: 32mm, 50mm, 70mm

WEIGHT: 45g/set (50mm)



TK-032SW 28-02

For Ø31.8 Carbon fork, inner tube expander.
For OD2 carbon

SPEC: Ø27.5 - Ø27.7 with shim

H: 45mm

WEIGHT: 44g/set



TK-016SW 28-03

For Ø25.4 Carbon fork, inner tube expander.

SPEC: Ø19 - Ø21
Ø21 - Ø22 with T0.5 shim
Ø22 - Ø23 with T1.0 shim

H: 40mm

WEIGHT: 35g/set



THRU AXLE

QUICK RELEASE

SEAT CLAMP

TOP CAP

HEADSETS PARTS

CRANK SET

CHAINRING SYSTEM

ROLLER KIT SERIES

BMX SERIES

CHAINRING PARTS

CHAIN GUIDE SYSTEM

BRAKE SYSTEM

SEATPOST

STEM SYSTEM

HANDLEBAR

AEROBAR SYSTEM

COMPUTER MOUNT

CAGE

ACCESSORIES

FITTING EQUIPMENT

PEDALS



EXT-2C

29-01

SPEC: Ø28.6 x Ø25.4
Ø25.4 x Ø22.2



ADP-STEM

29-02

Steering tube extend.
For Ø28.6 fork.

MATERIAL: AL6061-T6
LENGTH: 50mm, 90mm, 120mm
With top cap & long screw x2pcs for custom to assemble

Adjust the height (mm)

	MIN	MAX
50	47.5	65.5
90	47.5	105.5
120	47.5	135.5



Tool for star nut



TL-18

29-03

Star nut tooling.

SPEC: Ø25.4mm, Ø28.6mm



THRU AXLE

QUICK RELEASE

SEAT CLAMP

TOP CAP

HEADSETS PARTS

CRANK SET

CHAINRING SYSTEM

ROLLER KIT SERIES

BMX SERIES

CHAINRING PARTS

CHAIN GUIDE SYSTEM

BRAKE SYSTEM

SEATPOST

STEM SYSTEM

HANDLEBAR

AEROBAR SYSTEM

COMPUTER MOUNT

CAGE

ACCESSORIES

FITTING EQUIPMENT

PEDALS



LIGHT WEIGHT

AE-28.6-H

BEST SELLER

30-01

Alloy spacer.

P.A.T ED

SPEC: AE-28.6-H (ID $\varnothing 28.8 \pm 0.2$ x OD $\varnothing 34$)

H: As Order

COLOR: As Order



BEST SELLER

**AR-25.4-H / AR-28.6-H
AR-31.8-H / AR-38.1-H**

30-02

Alloy spacer.

SPEC: AR-25.4-H (ID $\varnothing 25.6 \pm 0.2$ x OD $\varnothing 32$)
AR-28.6-H (ID $\varnothing 28.8 \pm 0.2$ x OD $\varnothing 32.5$,
 $\varnothing 33$, $\varnothing 34$, $\varnothing 35$, $\varnothing 36$)
AR-31.8-H (ID $\varnothing 32.0 \pm 0.2$ x OD $\varnothing 38.8$)
AR-38.1-H (ID $\varnothing 38.3 \pm 0.2$ x OD $\varnothing 44$)

H: As Order

COLOR: As Order



ATR-28.6-5

30-03

Alloy taper spacer.

SPEC: ID $\varnothing 28.6$, OD-TOP $\varnothing 32.5$ mm

H: 5 / 10mm

COLOR: As Order

OPTION: OD-BOTTOM $\varnothing 34$ / $\varnothing 35$ / $\varnothing 36$ mm



BEST SELLER

**AC-25.4-H / AC-28.6-H
AC-31.8-H / AC-38.1-H**

30-04

Carbon spacer.

SPEC: AC-25.4-H (ID $\varnothing 25.6 \pm 0.2$ x OD $\varnothing 31.5$)
AC-28.6-H (ID $\varnothing 28.8 \pm 0.2$ x OD $\varnothing 34$)
AC-31.8-H (ID $\varnothing 32.0 \pm 0.2$ x OD $\varnothing 38.8$)
AC-38.1-H (ID $\varnothing 38.3 \pm 0.2$ x OD $\varnothing 45.2$)

H: As Order

COLOR: 3K, UD



UD Surface

LONG CARBON FIBER SPACER

30-05

Carbon Long fibers with nylon Injection material, can use and Create carbon high texture lightweight products. For more details please contact our engineers.

MATERIAL: Long carbon fiber-reinforced PA12 resin

COLOR: UD Surface, UD with painting

Custom design available



THRU AXLE

QUICK RELEASE

SEAT CLAMP

TOP CAP

HEADSETS PARTS

CRANK SET

CHAINING SYSTEM

ROLLER KIT SERIES

BMX SERIES

CHAINING PARTS

CHAIN GUIDE SYSTEM

BRAKE SYSTEM

SEATPOST

STEM SYSTEM

HANDLEBAR

AEROBAR SYSTEM

COMPUTER MOUNT

CAGE

ACCESSORIES

FITTING EQUIPMENT

PEDALS



AR-28.6-H

31-01

**Alloy spacer for Ø28.6 fork.
Carbon fiber steering tube please notify.**

MATERIAL: AL6061-T6

SPEC: ID 28.6+0.1+0.4 x OD Ø34mm / ID 28.6+0.1+0.4 x OD Ø36mm

H: OD Ø34/ 50, 100, 110, 120, 130, 140, 150, 160, 180, 200 mm

OD Ø36/ 50, 100, 110, 120, 130, 140, 150, 170, 200 mm

COLOR: Sand blast black, silver, Black, Silver, As Order



ACE-28.6-H ACE-31.8-H

BEST SELLER

31-02

Carbon spacer.

P.A.T ED

SPEC:

ACE-28.6-H (ID Ø28.8 x OD Ø34)

ACE-31.8-H (ID Ø32.0 x OD Ø38.8)

H: As Order

COLOR: 3K, UD



ARK-25.4-H ARK-28.6-H

31-03

Alloy spacer.

SPEC: ARK-25.4-H (ID Ø25.4 x OD Ø32)

ARK-28.6-H (ID Ø28.6 x OD Ø35)

H: As Order

COLOR: As Order



Automatic Cam Lathe For Spacer And Top Cap...

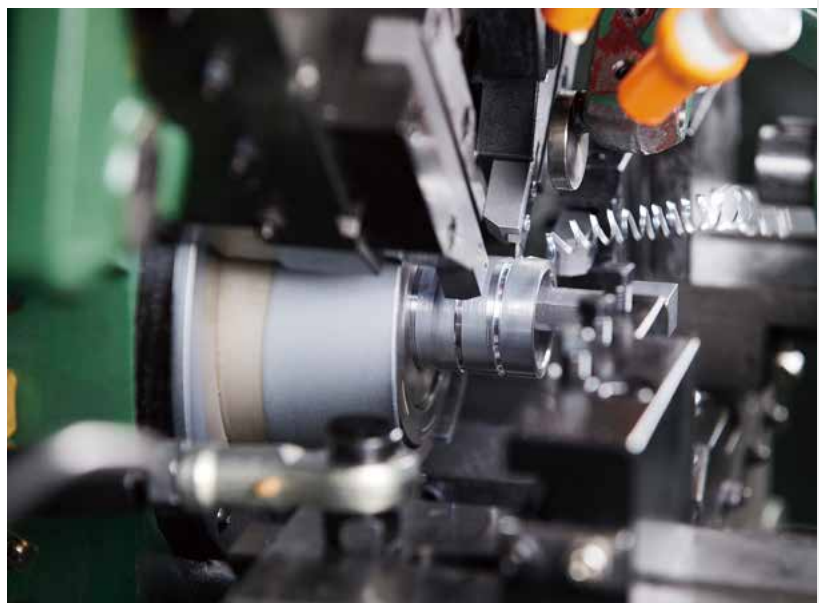



THRU AXLE

QUICK
RELEASE

SEAT CLAMP

TOP CAP

HEADSETS
PARTS

CRANK SET

CHAINRING
SYSTEM

ROLLER KIT
SERIES

BMX SERIES

CHAINRING
PARTS

CHAIN GUIDE
SYSTEM

BRAKE SYSTEM

SEATPOST

STEM SYSTEM

HANDLEBAR

AEROBAR
SYSTEM

COMPUTER
MOUNT

CAGE

ACCESSORIES

FITTING
EQUIPMENT

PEDALS





THRU AXLE

QUICK RELEASE

SEAT CLAMP

TOP CAP

HEADSETS PARTS

CRANK SET

CHAINRING SYSTEM

ROLLER KIT SERIES

BMX SERIES

CHAINRING PARTS

CHAIN GUIDE SYSTEM

BRAKE SYSTEM

SEATPOST

STEM SYSTEM

HANDLEBAR

AEROBAR SYSTEM

COMPUTER MOUNT

CAGE

ACCESSORIES

FITTING EQUIPMENT

PEDALS

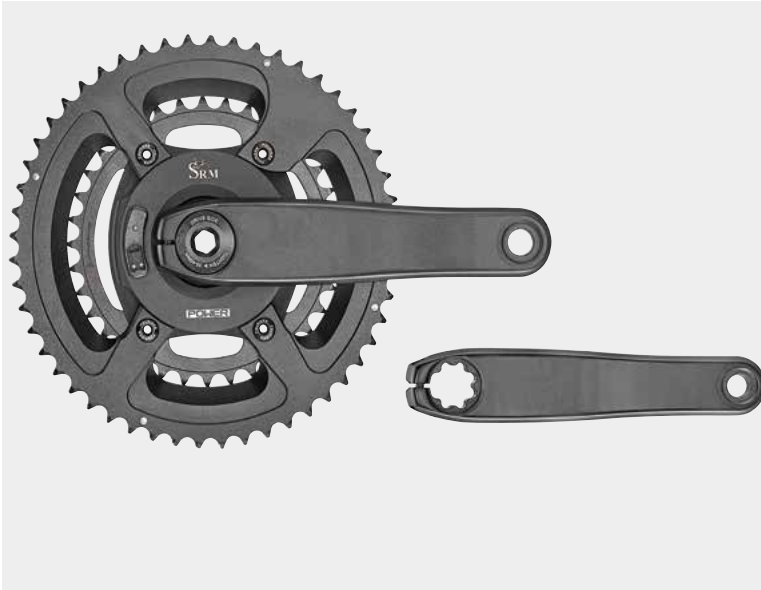

CK-GRA

33-01

SRM Spider PowerMeter with rechargeable system.

MATERIAL: SPINDLE: AL 2024

CHAINRING: AL7075-T651

CRANK: AL6066-T6 / Carbon fiber

CRANK LENGTH: AL6066-T6: 145, 147.5, 150, 152.5, 155, 157.5, 160, 162.5, 165, 167.5, 170, 172.5, 175mm

Carbon fiber: 145, 150, 155, 160, 165, 167.5, 170, 172.5, 175mm

GEAR COMBINATION: 34/50T, 36/52T, 39/53T, 42/54T, 42/55T

COLOR: S.B Black



ADP-FIT-CZ

33-02

Precision CNC machines fitting bike sizing cranks.

CRANK LENGTH: 145, 150, 155, 160, 165, 167.5, 170, 172.5, 175, 177.5, 180mm

AXLE: 24mm / 30mm

MATERIAL: CRANK: AL6061-T6

AXLE: AL 2024

CHAINRING: Single 46T



CX-MUTI

33-03

Fix SHIMANO® crankset with special chainring bolt.

MATERIAL: AL7075-T651 full CNC made

P.C.D.: Ø110mm

TEETH: 34T & 50T / 36T & 52T / 39T & 53T

Option



CX-MUTI-5800: For SHIMANO® FC-5800 crank / W/I T30 chainring bolt
CX-MUTI-6800: For SHIMANO® FC-6800 crank / W/I T30 chainring bolt
CX-MUTI-R7000: For SHIMANO® FC-R7000 crank / W/I T30 chainring bolt
CX-MUTI-R8000: For SHIMANO® FC-R8000 crank / W/I T30 chainring bolt
CX-MUTI-R9000: For SHIMANO® FC-R9000 crank / W/I T30 chainring bolt
CX-MUTI-R9100: For SHIMANO® FC-R9100 crank / W/I T30 chainring bolt



THRU AXLE

QUICK
RELEASE

SEAT CLAMP

TOP CAP

HEADSETS
PARTS

CRANK SET

CHAINRING
SYSTEMROLLER KIT
SERIES

BMX SERIES

CHAINRING
PARTSCHAIN GUIDE
SYSTEM

BRAKE SYSTEM

SEATPOST

STEM SYSTEM

HANDLEBAR

AEROBAR
SYSTEMCOMPUTER
MOUNT

CAGE

ACCESSORIES

FITTING
EQUIPMENT

PEDALS

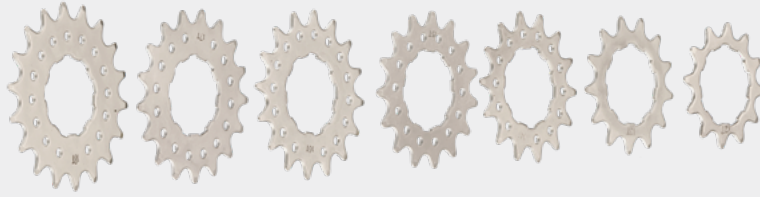
**TRSK**

34-01

For SHIMANO® cassette.**MATERIAL:**

Cold forged Cr-Mo steel (ASM4140)
Heat treated (Harden+double temple)
N.E.N finish

TEETH: 12T - 20T**T:** 3/32" (1.8mm)**TRSK-F**

34-02

For SHIMANO® cassette.**MATERIAL:**

Cold forged Cr-Mo steel (ASM4140)
Heat treated (Harden+double temple)
N.E.N finish

TEETH: 13T - 18T, 20T**H:** 7mm**T:** 3/32" (1.8mm)**TRST**

34-03

MATERIAL:

Cold forged Cr-Mo steel (ASM4140)
Heat treated (Harden+double temple)
N.E.N finish

TEETH: 13T - 23T (1.37 x 24T (R) lock ring)**H:** 7mm**T:** 3/32" (1.8mm), 1/8" (3mm)**OPTION:** Add 1.29 x 24T (L) lock ring,
Surface ED finished**TRSK-66**

34-04

For SHIMANO® cassette.**MATERIAL:**

Cold forged Cr-Mo steel (ASM4140)
Heat treated (Harden + double temple)
N.E.N finish

TEETH: 16T - 23T**WEIGHT:** 56g/pcs (16T)**OPTION:** Black ED**TRSK-R6**

34-05

For disc hub 6 hole.**MATERIAL:**

Cold forged Cr-Mo steel (ASM4140)
Heat treated (Harden + double temple)
N.E.N finish

TEETH: 16T - 23T**WEIGHT:** 29.5g/pcs (16T)**OPTION:** Black ED**TRSK-TY**

34-06

For SHIMANO® cassette.**MATERIAL:**

Cold forged Cr-Mo steel (ASM4140)
Heat treated (Harden + double temple)
N.E.N finish

TEETH: 12T, 15T - 23T**WEIGHT:** 62.5g/pcs (18T)

CHAINRING SYSTEM

35



THRU AXLE

QUICK RELEASE

SEAT CLAMP

TOP CAP

HEADSETS PARTS

CRANK SET

CHAINRING SYSTEM

ROLLER KIT SERIES

BMX SERIES

CHAINRING PARTS

CHAIN GUIDE SYSTEM

BRAKE SYSTEM

SEATPOST

STEM SYSTEM

HANDLEBAR

AEROBAR SYSTEM

COMPUTER MOUNT

CAGE

ACCESSORIES

FITTING EQUIPMENT

PEDALS

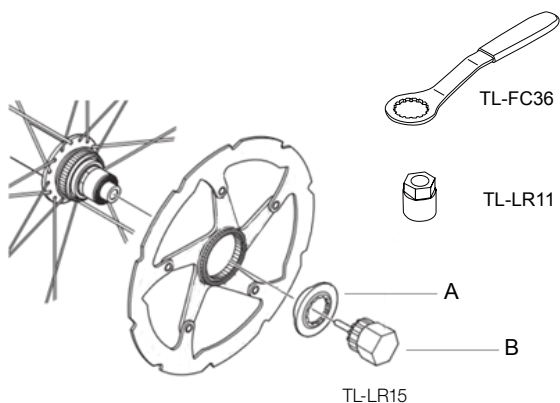

	Internally serrated type	Externally serrated type	Internally and externally serrated type
A. Disc brake rotor fixing lock ring From Mr.control	 M-SH44	 M-SH1521-CR	 M-SH3611
B. Lock ring tightening tool From SHIMANO®	TL-LR15 Adjustable wrench	TL-FC36	TL-FC36/TL-LR11 Adjustable wrench



M-SH1521-CR

35-01

For SHIMANO® center-lock. 15 / 20mm thru-axle disc system hub.

MATERIAL: Cr-Mo heat treated
SPEC: OD Ø44 x ID Ø27
COLOR: ED finished



M-SH3611 **BEST SELLER**

35-02

Lock ring for SHIMANO® center-lock. 15 / 20mm thru-axle disc system hub.

MATERIAL: AL6061
SPEC: OD Ø44 x ID Ø27
COLOR: As Order



M-SH44

35-03

For SHIMANO® center-lock disc system hub.

MATERIAL: AL6061
SPEC: OD Ø44
COLOR: As Order



LOCK RING

35-04

MATERIAL: Cr-Mo heat treated
SPEC: 1.29 x 24T (L)



M-HUB

35-05

Hub ring nut (free wheel).

MATERIAL: AL6061-T651
OPTION: 11T (OD: Ø35.5)
12T (OD: Ø38)



AR-HUB-2

35-06

For SHIMANO® hub. 11 speed change to 10 speed.

MATERIAL: AL6061
SPEC: OD Ø38.8
H: 2mm



AR-HUB

35-07

Spacer for cassette hub.

MATERIAL: AL6061
SPEC: OD Ø38.8
H: As Order



SSP-SET-T **BEST SELLER**

35-08

A: TRSK (12T-18T) choose 1 pcs
B: AR-HUB 10mm x 2 pcs
5mm x 1 pcs
3mm x 4 pcs
C: M-HUB (12T) x 1



THRU AXLE

QUICK RELEASE

SEAT CLAMP

TOP CAP

HEADSETS PARTS

CRANK SET

CHAINRING SYSTEM

ROLLER KIT SERIES

BMX SERIES

CHAINRING PARTS

CHAIN GUIDE SYSTEM

BRAKE SYSTEM

SEATPOST

STEM SYSTEM

HANDLEBAR

AEROBAR SYSTEM

COMPUTER MOUNT

CAGE

ACCESSORIES

FITTING EQUIPMENT

PEDALS



▲ 4-Axis Milling Machine



▼ 3+2-Axis Machine



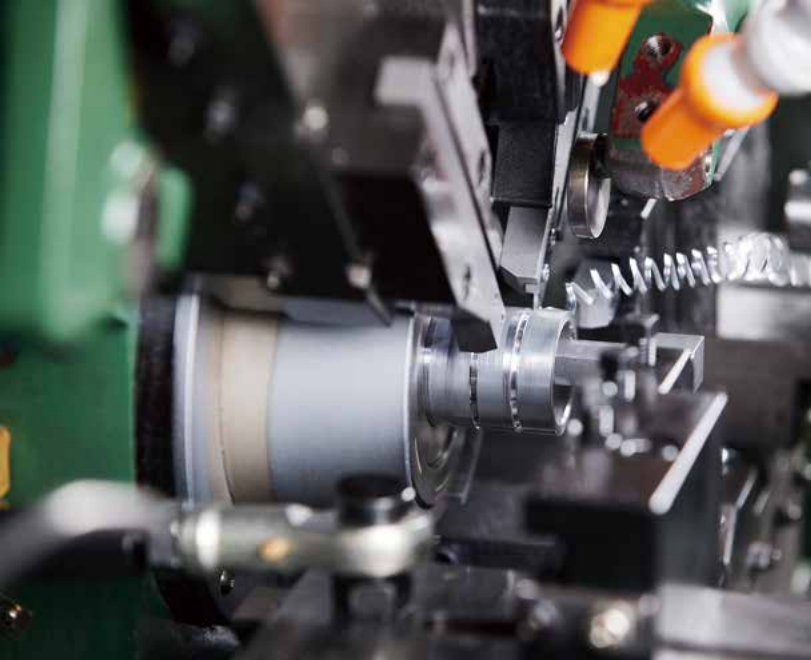

▲ Automatic Cam Lathe For Spacer And Top Cap...

Mr.control™
Since 1991

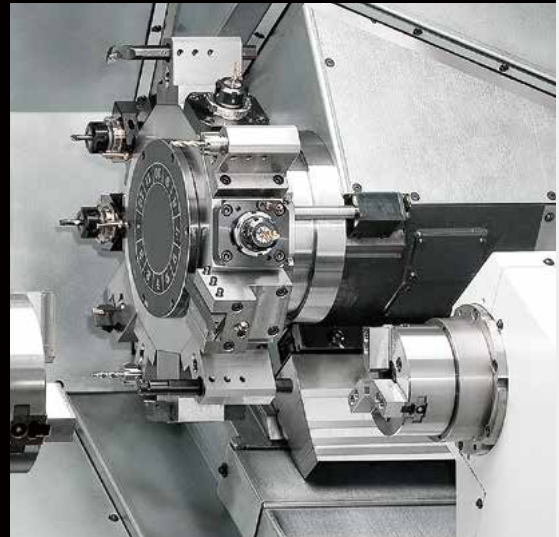

▲ CNC Turning Lathe

▼ Swiss Lathe



Specifications are subject to change without notice.



THRU AXLE

QUICK RELEASE

SEAT CLAMP

TOP CAP

HEADSETS PARTS

CRANK SET

CHAINRING SYSTEM

ROLLER KIT SERIES

BMX SERIES

CHAINRING PARTS

CHAIN GUIDE SYSTEM

BRAKE SYSTEM

SEATPOST

STEM SYSTEM

HANDLEBAR

AEROBAR SYSTEM

COMPUTER MOUNT

CAGE

ACCESSORIES

FITTING EQUIPMENT

PEDALS

ROLLER KIT SERIES

CUSTOM DESIGN AVAILABLE

THRU AXLE

QUICK RELEASE

SEAT CLAMP

TOP CAP

HEADSETS PARTS

CRANK SET

CHAINRING SYSTEM

ROLLER KIT SERIES

BMX SERIES

CHAINRING PARTS

CHAIN GUIDE SYSTEM

BRAKE SYSTEM

SEATPOST

STEM SYSTEM

HANDLEBAR

AEROBAR SYSTEM

COMPUTER MOUNT

CAGE

ACCESSORIES

FITTING EQUIPMENT

PEDALS



SSP-12US-1 (34) 38-01

Two pulley design.
MATERIAL: AL6061-T6
 Outline spring design
T: 12T - 13T

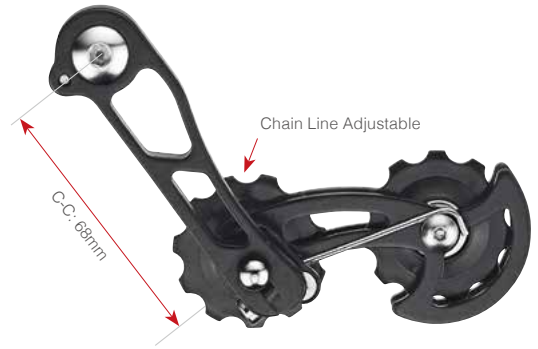

SSP-12US-1 (68) 38-02

Two pulley design.
MATERIAL: AL6061-T6
 Outline spring design
T: 19T - 20T

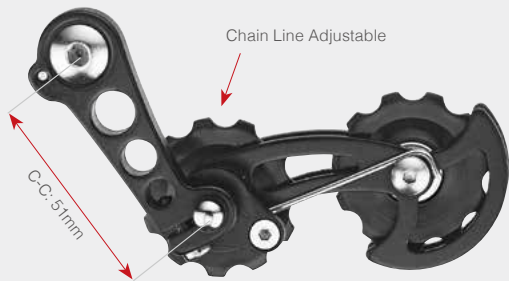

SSP-12US-1 (51) 38-03

Two pulley design.
MATERIAL: AL6061-T6
 Outline spring design
T: 16T - 18T

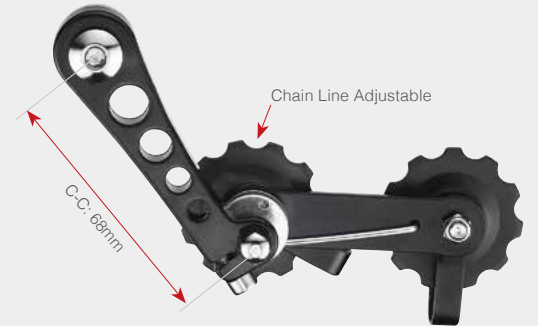

SSP-12-1 38-04

MATERIAL: AL6061-T6
T: 16T - 20T

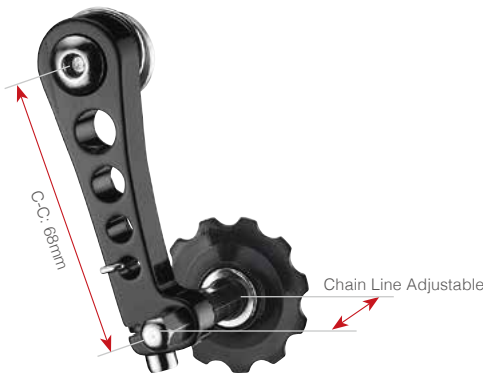

SSP-11-1 38-05

MATERIAL: AL6061-T6
 Outline spring design
T: 16-20T

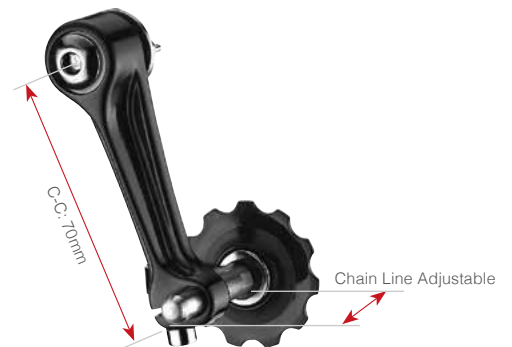

SSP-11 / SSP-11-V1 38-06

MATERIAL: AL6061-T6
 Built-in spring design
T: 16-20T



SSP-FOOT-1 38-07

Bearing roller type.
 For single speed.
MATERIAL: AL6061-T6 CNC made



ROLLER KIT SERIES

39



SHIMANO®	SYSTEM	ULTEGRA	DURA-ACE	105
Mr. Control	MODEL	RD-R8150(12SDI2)	RD-R9250(12SDI2)	RD-R7150(12SDI2) RD-R71000(12S)
SSP-SR98N-1218	12+18T(CARBON)	•	•	
SSP-SR98A-1218	12+18T(ALLOY)	•	•	
SSP-SR71CO-1218	12+18T(CARBON)			•
SSP-SR71A-1218	12+18T(ALLOY)			•
SSP-SR71N-1218	12+18T(CARBON)			•

SRAM®	SYSTEM	EI	AXS
Mr. Control	MODEL	RED(E1)/FORCE(E1)	RED/FORCE
SSP-SRE1CO-1218	12+18T(CARBON)	•	
SSP-SRE1A-1218	12+18T(ALLOY)	•	
SSP-SRE1N-1218	12+18T(CARBON)	•	
ISSP-AXCO-ROLLER KIT	12+16T(ALLOY)		•
SSP-AX-ROLLER KIT	12+16T(ALLOY)		•

THRU AXLE

QUICK RELEASE

SEAT CLAMP

TOP CAP

HEADSETS PARTS

CRANK SET

CHAINRING SYSTEM

ROLLER KIT SERIES

BMX SERIES

CHAINRING PARTS

CHAIN GUIDE SYSTEM

BRAKE SYSTEM

SEATPOST

STEM SYSTEM

HANDLEBAR

AEROBAR SYSTEM

COMPUTER MOUNT

CAGE

ACCESSORIES

FITTING EQUIPMENT

PEDALS



NEW
SSP-SRE1CO-1218 39-01

12T/18T Carbon pulley with carbon/alloy cage for SRAM® AXS RED E1/FORCE E1.

MATERIAL: Carbon/Alloy Cage/Carbon pulley
SPEC: 12T+18T
FOR: SRAM® AXS RED E1/FORCE E1.
COLOR: UD Carbon
OPTION: Ceramics ball bearing



NEW
SSP-SR71CO-1218 39-02

12T/18T Carbon pulley with carbon/alloy cage for RD-R7150 12S (105 DI2)/RD R7100 12S.

MATERIAL: Carbon/Alloy Cage/Carbon fiber pulley
SPEC: 12T+18T
FOR: SHIMANO® R7150 12S (105 DI2)/RD R7100 12S
COLOR: UD Carbon
OPTION: Ceramics ball bearing



NEW
SSP-SR71A-1218 39-03

12T/18T AL7075-T651 Pulley with carbon 3k cage for RD-R7150 12S (105 DI2)/RD R7100 12S.

MATERIAL: Carbon 3k Cage/AL7075-T651 Pulley
SPEC: 12T+18T
FOR: SHIMANO® R7150 12S (105 DI2)/RD R7100 12S
COLOR: 3K Carbon
OPTION: Ceramics ball bearing.



NEW
SSP-SR98A-1218 39-04

12T/18T AL7075-T651 Pulley with carbon cage for RD-R9250 12S (DURA-ACE DI2)/RD-R8150 12S (ULTEGRA DI2) .

MATERIAL: Carbon Cage/AL7075-T651 Pulley
SPEC: 12T+18T
FOR: SHIMANO® RD-R9250 12S(DURA-ACE DI2)/RD-R8150 12S (ULTEGRA DI2)
COLOR: 3K Carbon



NEW
SSP-SR71N-1218 39-05

12T/18T Carbon pulley with carbon 3k cage for RD-R7150 12S (105 DI2)/RD R7100 12S.

MATERIAL: Carbon 3k Cage/Carbon pulley
SPEC: 12T+18T
FOR: SHIMANO® R7150 12S (105 DI2)/RD R7100 12S
COLOR: 3K Carbon
OPTION: Ceramics ball bearing.



NEW
SSP-SR98N-1218 39-06

12T/18T Carbon pulley with carbon cage for RD-R9250 12S (DURA-ACE DI2)/RD-R8150 12S (ULTEGRA DI2) .

MATERIAL: Carbon Cage/Carbon pulley
SPEC: 12T+18T
FOR: SHIMANO® RD-R9250 12S (DURA-ACE DI2)/RD-R8150 12S (ULTEGRA DI2)
COLOR: 3K Carbon
OPTION: Ceramics ball bearing.



THRU AXLE

QUICK
RELEASE

SEAT CLAMP

TOP CAP

HEADSETS
PARTS

CRANK SET

CHAINRING
SYSTEMROLLER KIT
SERIES

BMX SERIES

CHAINRING
PARTSCHAIN GUIDE
SYSTEM

BRAKE SYSTEM

SEATPOST

STEM SYSTEM

HANDLEBAR

AEROBAR
SYSTEMCOMPUTER
MOUNT

CAGE

ACCESSORIES

FITTING
EQUIPMENT

PEDALS



NEW SSP-SRE1A-1218

40-01

12T/18T AL7075-T651 pulley with carbon 3K cage for SRAM® AXS RED E1/FORCE E1.

MATERIAL: Carbon 3K Cage/AL7075-T651 Pulley

SPEC: 12T+18T

FOR: SRAM® AXS RED E1/FORCE E1.

COLOR: 3K Carbon

OPTION: Ceramics ball bearing.



NEW SSP-SRE1N-1218

40-02

12T/18T carbon with carbon cage for SRAM® AXS RED E1/FORCE E1.

MATERIAL: Carbon Cage/Carbon pulley

SPEC: 12T+18T

FOR: SRAM® AXS RED E1/FORCE E1.

COLOR: 3K Carbon

OPTION: Ceramics ball bearing.



NEW SSP-AXCO-ROLLER KIT

40-03

Upper12T/Lower16T derailleur cage for SRAM® RED AXS/FORCE/RIVAL 12 speed system.

MATERIAL: Carbon Cage/AL7075-T651 PULLEY

SPEC:

SRAM® RED AXS / FORCE / RIVAL derailleur SYSTEM.

COLOR: 3K Carbon

WEIGHT: 58g



SSP-AX-ROLLER KIT

40-04

MATERIAL: AL6061-T6 Cage

AL7075-T651 Pulley

SPEC: SRAM® AXS derailleur system

COLOR: As Order

WEIGHT: 67g/set

OPTION: Ceramics ball bearing

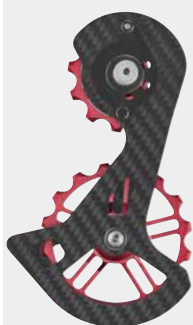

SSP-R91-CO ROLLER KIT

40-05

Oversize derailleur cage with 12T upper and 16T lower pulley. With carbon plate. Pulley are full CNC made from AL7075-T651 with Cr-Mo or steel bearing. Compatible with SHIMANO® RD 9150 / RD 8050 / RD 9100SS.

MATERIAL: Carbon Cage & AL7075-T651 Pulley

SPEC: Fit SHIMANO® RD 8050 / RD 9150 / RD 9100SS

COLOR: As Order

OPTION: Ceramics ball bearing

Not available in Japan



SSP-R8050 ROLLER KIT

40-06

Oversize derailleur cage with 12T upper and 16T lower pulley. Pulley are full CNC made from AL7075-T651 with Cr-Mo or steel bearing. Compatible with SHIMANO® RD 8050 / RD 8000.

MATERIAL: AL6061-T6 Cage

AL7075-T651 Pulley

SPEC: Fit SHIMANO® RD 8050 / RD 8000

COLOR: As Order

OPTION: Ceramics ball bearing

Not available in Japan



SSP-R91-1216 ROLLER KIT

40-07

Oversize derailleur cage with 12T upper and 16T lower pulley. Pulley are full CNC made from AL7075-T651 With Cr-Mo or steel bearing. Compatible with SHIMANO® RD 9100SS.

MATERIAL: AL6061-T6 Cage
AL7050-T651 Pulley

SPEC: Fit SHIMANO® RD 9100-SS

Fit SHIMANO® RD 9150-SS

OPTION: Ceramics ball bearing

Not available in Japan



SSP-CARBON ROLLER KIT

40-08

12T and 16T R.D over size pulley cage for reduced drivetrain friction with Cr-Mo steel bearing.

MATERIAL: Carbon Cage & AL7075-T651 Pulley

FOR: Fit SHIMANO® RD 9000 / 9070 / 6800 / 6870

COLOR: 3K carbon

WEIGHT: 60g/set

OPTION: Ceramics ball bearing

Not available in Japan



THRU AXLE

QUICK RELEASE

SEAT CLAMP

TOP CAP

HEADSETS PARTS

CRANK SET

CHAINING SYSTEM

ROLLER KIT SERIES

BMX SERIES

CHAINING PARTS

CHAIN GUIDE SYSTEM

BRAKE SYSTEM

SEATPOST

STEM SYSTEM

HANDLEBAR

AEROBAR SYSTEM

COMPUTER MOUNT

CAGE

ACCESSORIES

FITTING EQUIPMENT

PEDALS



PEG-COMBO

41-01

Cr-Mo peg with EMS (SWISS®) harden nylon sleeve. For both park and street.

MATERIAL: ASM 4130 **heat treatment** Cr-Mo peg With EMS (SWISS®) harden nylon sleeve

SPEC: Ø40 x (L)107mm for combo use
Ø33.6 x (L)104.5mm for only Cr-Mo-peg use
With 5 anti rotate pin position

COLOR: Cr-Mo peg cp / Red / Blue / Black
Nylon sleeve blue / Red / Black / White

WEIGHT: Combo 203g / Cr-Mo 165.5g
OPTION: Solid color or transparent color

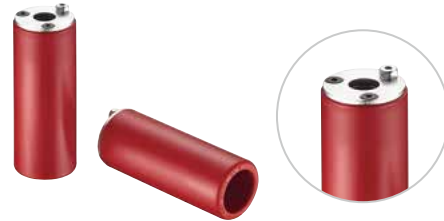

PEG-GL

41-02

MATERIAL: EMS (SWISS®) super harden nylon

SPEC: Ø40 x (L)100mm

WEIGHT: 90g/pcs

COLOR: Blue, Yellow, White, Red, Violet, Black, Green, Orange, Pink

OPTION: With Mr.control sticker



PEG-4130-F4-L

41-03

MATERIAL: ASM 4130 **heat treatment** Cr-Mo With CNC finished

SPEC: Ø34 x (L)110mm with 3/8 adapter
With 4 anti rotate pin position

WEIGHT: 180g/pcs



PEG-4130-F4

41-04

MATERIAL: ASM 4130 Cr-Mo cold forged **heat treatment** CNC finished

SPEC: Ø34 x (L)95mm

WEIGHT: 160g/pcs (With lock hold)



PEG-4130-F

41-05

MATERIAL: ASM 4130 Cr-Mo cold forged

SPEC: Ø35 x (L)80mm, Ø35 x (L)90mm

WEIGHT: 200g/pcs

Heat treatment: Quenching+ two tempering

THRU AXLE

QUICK
RELEASE

SEAT CLAMP

TOP CAP

HEADSETS
PARTS

CRANK SET

CHAINRING
SYSTEMROLLER KIT
SERIES

BMX SERIES

CHAINRING
PARTSCHAIN GUIDE
SYSTEM

BRAKE SYSTEM

SEATPOST

STEM SYSTEM

HANDLEBAR

AEROBAR
SYSTEMCOMPUTER
MOUNT

CAGE

ACCESSORIES

FITTING
EQUIPMENT

PEDALS

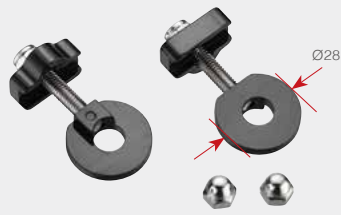
**RH-SP28-S**

42-01

Alloy chain adjuster.

SPEC: Ø14 x14w, Ø10 x10w
S: Single guide
 Shorter for small dropout

**RH-SP25-S**

42-02

Alloy chain adjuster.

SPEC: Ø14 x14w, Ø10 x10w
S: Single guide
 Shorter for small dropout

**RH-MG**

42-03

Chain adjuster.

MATERIAL: AL6061-T6
OPTION: 10mm, 14mm

**RH-MGC**

42-04

Chain adjuster.

MATERIAL: AL6061-T6 CNC finished
OPTION: 10mm, 14mm

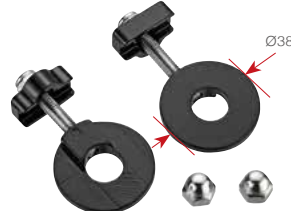
**RH-SP38-S**

42-05

Alloy chain adjuster.

SPEC: Ø14 x14w, Ø10 x10w
 Shorter for small dropout

**RH-SP25**

42-06

Alloy chain adjuster.

SPEC: Ø14 x14w, Ø10 x10w
 Shorter for small dropout

**RH-AT09**

42-07

Chain adjuster.
 For 10mm or 14mm dropout.

MATERIAL: AL6061-T6
OPTION: 3 different length bolt
 12mm, 15mm, 18mm

**RH-AT09-H**

42-08

Chain adjuster.
 For 10mm or 14mm dropout.

MATERIAL: AL6061-T6 CNC finished
OPTION: 3 different length bolt
 12mm, 15mm, 18mm

**RH-STAR**

42-09

Chain adjuster.
 For 10mm dropout.

MATERIAL: AL6061-T6

**RH-ARROW**

42-10

Chain adjuster involute profile design.
 For 14mm dropout.

MATERIAL: AL6061-T6

**RH-112A**

42-11

Chain adjuster.
 For 5mm, 7mm dropout.

MATERIAL:
 Steel bolt + AL6061-T6 nut
AXLE: 10mm

**RH-112-E**

42-12

Chain adjuster.
 For 5mm dropout.

MATERIAL: Steel bolt
AXLE: 10mm

**RH-RD10**

42-13

Alloy adjuster.
 Special design available.

MATERIAL: AL6061-T6



ITEM	P.C.D SPEC	CHAINRING SPEC
CX-XTR-DIR	XTRIXT12S	30/32/34/36
CX-XTR12S-DI2	XTR/XT DI212S	30/32/34/36/38/40/42
CX-TD-DIR	SRAM® TTYPE (8BOLT)	30/32/34/36
CX-DA12S	FC-P9200	56/58/60/62
CX-UT12S	FC-R8100	56/58/60/62
CX-10512S	FC-R7100	56/58/60/62

ITEM	P.C.D SPEC		CHAINRING SPEC
CX 1042S	104mm	Standard	30 / 32 / 34 / 36 / 38 / 40 / 42 / 44 / 46 / 48
CX 1042S OV	104mm	Standard	34 / 36 / 38 / 40 / 42 / 44 / 46 / 48
CX 130S	130mm	Standard	38 / 40 / 42

ITEM	P.C.D SPEC		CHAINRING SPEC
CX 110S	110mm	Standard	38 / 40 / 42
CX 110S 68	110mm	FC6800 / ULTEGRA	40 / 42 / 44 / 46 / 48
CX 110S 58	110mm	FC5800 105	40 / 42 / 44 / 46 / 48
CX 120S	120mm	SRAM® Standard	36 / 38 / 40
CX 76X11S	76mm	SRAM® XX1 System	30 / 32 / 34 / 36
CX GX94S	94mm	SRAM® GX Crank System	32 / 34 / 36
CX GXPS	-	GXP System	30 / 32 / 34 / 36 / 38



NEW
CX-XTR12S-DI2 43-01
 Narrow wide chainring for new XTR/XT DI2 12speed direct mount crank.
MATERIAL: AL7075-T651
TEETH: 30T / 32T / 34T / 36T / 40T / 42T
SPEC: XTR / XT DI2 12speed
COLOR: As Order
WEIGHT: 70g (36T)



CX-TD-DIR 43-02
 Narrow wide chainring for SRAM® T type crank.
MATERIAL: AL7075-T651
TEETH: 30T / 32T / 34T / 36T
SPEC: SRAM® T type direct mount 8-bolt
OFFSET: 3mm for chainline 55mm



CX-XTR-DIR 43-03
 Narrow Wide chainring for XTR / XT 12 speed crank.
MATERIAL: AL7075-T651
TEETH: 30T / 32T / 34T / 36T
SPEC: XTR/XT Direct mount

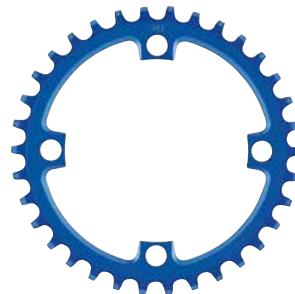

CX-1042S 43-04
MATERIAL: AL7075-T651
P.C.D: Ø104mm
TEETH: 30T / 32T / 34T / 36T / 38T / 40T
HIGHT: 4mm
WEIGHT: 46.5g/pcs (34T)



THRU AXLE

QUICK RELEASE

SEAT CLAMP

TOP CAP

HEADSETS PARTS

CRANK SET

CHAINRING SYSTEM

ROLLER KIT SERIES

BMX SERIES

CHAINRING PARTS

CHAIN GUIDE SYSTEM

BRAKE SYSTEM

SEATPOST

STEM SYSTEM

HANDLEBAR

AEROBAR SYSTEM

COMPUTER MOUNT

CAGE

ACCESSORIES

FITTING EQUIPMENT

PEDALS



THRU AXLE

QUICK RELEASE

SEAT CLAMP

TOP CAP

HEADSETS PARTS

CRANK SET

CHAINRING SYSTEM

ROLLER KIT SERIES

BMX SERIES

CHAINRING PARTS

CHAIN GUIDE SYSTEM

BRAKE SYSTEM

SEATPOST

STEM SYSTEM

HANDLEBAR

AEROBAR SYSTEM

COMPUTER MOUNT

CAGE

ACCESSORIES

FITTING EQUIPMENT

PEDALS

NEW

CX-DA12S/CX-UT12S/CX-10512S

44-01

Narrow wide chainring for SHIMANO® 12 speed crank. With mud remove design on teeth shape. Fix SHIMANO® crankset with special bolt.

MATERIAL: AL7075-T651 full CNC made
P.C.D: Ø110mm
TEETH SPEC: 56T/58T/60T/62T/64T/66T
CRANK COVER CAP MATERIAL: AL7075-T651
CHAINRING BOLT MATERIAL: AL7075-T651

Option



CX-DA12S For SHIMANO® FC-R9200 crank
 CX-UT12S For SHIMANO® FC-R8100 crank
 CX-10512S For SHIMANO® FC-R7100 crank



CX-CR-L

44-02

MATERIAL: CR-MO steel heat treatment
TEETH SPEC: 25T / 28T / 30T
HIGHT: 3mm
COLOR: ED BK



CX-E-MOTO

44-03

E motor chainring with mud remove design on teeth shape.

FIT: 420 chain
MATERIAL: AL7075-T651
P.C.D: Ø68.5 Hole
TEETH: 58T / 60T / 62T / 64T
COLOR: As Order
 Custom design available



FTP-36 FTP-53E FTP-53H FTP-0352

P.A.T ED



FTP-36 / FTP-53H FTP-53E / FTP-0352

44-04

Chain catcher for Road bike.

FIX: 36T - 46T (FTP-36)
 34T - 50T, 39T - 53T (FTP-53)
 Triple (FTP-0352)
WEIGHT: 10g/pcs (FTP-36), 12g/pcs (FTP-53E)
 11g/pcs (FTP-53H), 9.2g/pcs (FTP-0352)
COLOR: As Order



FTP-AERO

44-05

Cold forged AL6061-T6.

FIX: 34T - 50T & 39T - 53T
WEIGHT: 33g/pcs

CHAIN GUIDE SYSTEM

45



THRU AXLE

QUICK
RELEASE

SEAT CLAMP

TOP CAP

HEADSETS
PARTS

CRANK SET

CHAINRING
SYSTEM

ROLLER KIT
SERIES

BMX SERIES

CHAINRING
PARTS

**CHAIN GUIDE
SYSTEM**

BRAKE SYSTEM

SEATPOST

STEM SYSTEM

HANDLEBAR

AEROBAR
SYSTEM

COMPUTER
MOUNT

CAGE

ACCESSORIES

FITTING
EQUIPMENT

PEDALS



CHAIN GUIDE SYSTEM

CUSTOM DESIGN AVAILABLE

Qualified with some country rule as chainring have to cover from centreline to back at least 25mm.

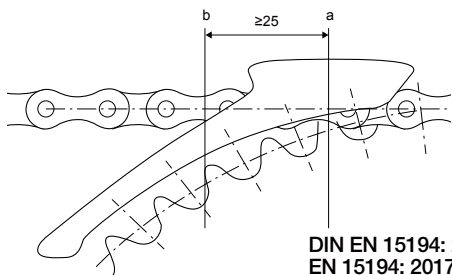

DIN EN 15194: 2017-12
EN 15194: 2017 (D)

Easy to set up the top guide position



DESIGN:
CH-MINI UPPER
CH-MED2 UPPER

CH-E8-MED2 CH-E8-MED CH-E8-MINI

CH-E8-MED2 CH-E8-MED CH-E8-MINI

46-01

**Design for SHIMANO® E8000 system.
Easy to set up the top guide position.**

MATERIAL: AL6061-T6
SPEC: E8000
RANGE: 30T - 40T
COLOR: As Order
OPTION: Spacer thickness

2.5mm

5mm

0.5mm

Standards compliant EN 15194: 2017-12

CH-GN4-MED2 CH-GN4-MED CH-GN4-MINI

CH-GN4-MED2 CH-GN4-MED CH-GN4-MINI

46-02

For BOSCH® Gn4 chain guide.

MATERIAL: AL6061-T6
RANGE: 32T - 38T
COLOR: As Order
OPTION: Spacer thickness

2.5mm

5mm

0.5mm

Standards compliant EN 15194: 2017-12

CH-BOSCX-MED2 CH-BOSCX-MED CH-BOSCX-MINI

CH-BOSCX-MED2 CH-BOSCX-MED CH-BOSCX-MINI

46-03

For BOSCH® CX chain guide.

MATERIAL: AL6061-T6
SPEC: BOSCH® CX
RANGE: 32T-38T
COLOR: As Order
OPTION: Spacer thickness

2.5mm

5mm

0.5mm

Standards compliant EN 15194: 2017-12

CHAIN GUIDE SYSTEM

47



ISCG

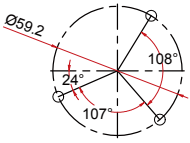

ISCG 05

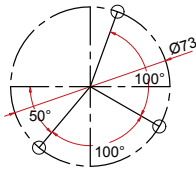

SHIMANO® E8000

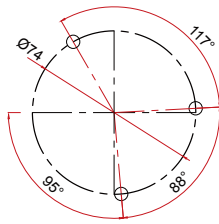

Bosch® GN4

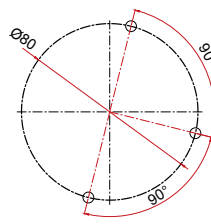

Bosch® CX

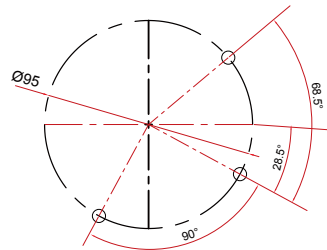

THRU AXLE

QUICK RELEASE

SEAT CLAMP

TOP CAP

HEADSETS PARTS

CRANK SET

CHAINRING SYSTEM

ROLLER KIT SERIES

BMX SERIES

CHAINRING PARTS

CHAIN GUIDE SYSTEM

BRAKE SYSTEM

SEATPOST

STEM SYSTEM

HANDLEBAR

AEROBAR SYSTEM

COMPUTER MOUNT

CAGE

ACCESSORIES

FITTING EQUIPMENT

PEDALS



CH-R1-MINI

47-01

Design for mtb 1x system drivetrain.
Carbon long fibers with nylon Injection.
Without ADP-N.
Easy to set up the top guide position.

MATERIAL: Carbon with nylon
SPEC: ISCG-05
RANGE: 30T - 36T
WEIGHT: 28g/set



CH-A1-MINI

47-02

Design for mtb 1x system drivetrain.
Without ADP-N.
Easy to set up the top guide position.

MATERIAL: AL6061-T6 forged
SPEC: ISCG-05
RANGE: 30T - 38T
WEIGHT: 35.8g/set
COLOR: As Order



NEW CH-MTS-MED2

47-03

Chain guide for 1X system ,BB mount version.

MATERIAL: ARM AL6061T6 / UPPER GUARD GV5H
SPEC: SB BLACK
RANGE: 30T-38T
Include spacers for chainline adjust.



CH-DDS1-MINI

47-04

Chain guard for 1 by 9, 10, 11 speed drivetrain.

MATERIAL: AL6061-T6 full CNC made
SPEC: Direct mount type guard
RANGE: 30T - 38T
COLOR: As Order



CH-ES-LD

47-05

Low-profile, low direct mount chain guard for 1X drivetrains. Carbon injection body, with a nylon guide that is easy to adjust and quiet on your chain.

MATERIAL: Carbon body / nylon cage
SPEC: Low direct mount system
RANGE: 32T - 36T
COLOR: Black
WEIGHT: 17g/set





CUSTOM DESIGN AVAILABLE

THRU AXLE

QUICK
RELEASE

SEAT CLAMP

TOP CAP

HEADSETS
PARTS

CRANK SET

CHAINRING
SYSTEMROLLER KIT
SERIES

BMX SERIES

CHAINRING
PARTSCHAIN GUIDE
SYSTEM

BRAKE SYSTEM

SEATPOST

STEM SYSTEM

HANDLEBAR

AEROBAR
SYSTEMCOMPUTER
MOUNT

CAGE

ACCESSORIES

FITTING
EQUIPMENT

PEDALS



CH-DLG9T

48-01

Chain guard with pulley style and bashguard.

MATERIAL: AL-6061T6
SPEC: ISCG 05
TEETH: 28-34T
COLOR: BLACK



CH-DLR

48-02

Chain guard with roller style and bashguard.

MATERIAL: AL-6061T6/NYLON
SPEC: ISCG 05
TEETH: 28-34T
COLOR: BLACK



CH-ESG

48-03

Chain guide with bash guard. Bash guard made by strong swiss plastic. With ADP-N for E-type BB mount.

MATERIAL: AL6061-T6
SPEC: ISCG or ISCG-05
RANGE: 32T - 38T
WEIGHT: 240g/set
COLOR: As Order



CH-G23-MED2

48-04

For MTB 1 X system drivetrain with bash guard.

MATERIAL: AL6061-T6/ Nylon
SPEC: ISCG 05
TEETH: 28-34T
COLOR: As Order



CH-ES-32

48-05

Chain guide with bash guard, light weight design, bash guard made by swiss material.

MATERIAL: AL6061-T6
SPEC: ISCG-05
RANGE: 28T - 32T
COLOR: As Order



**NEW**

CH-ES3-LW

49-01

Light weight design bash guard for single speed.

MATERIAL: AL6061-T6
SPEC: ISCG-05
RANGE: 28T-36T
COLOR: As Order
WEIGHT: 45g

Anti-Chainsuck



CH-ES3

49-02

Chaining protector for single speed to prevent rocks hitting the chaining. With ADP-N for E-type BB mount.

MATERIAL: AL6061-T6
SPEC: ISCG or ISCG-05
RANGE: 28T - 40T
WEIGHT: 142g/set
COLOR: As Order



CH-EX

49-03

With ADP-N for E-type BB mount.

MATERIAL: AL6061-T6
SPEC: ISCG or ISCG-05
FIX: 32T - 38T



CH-EX-S

49-04

With ADP-N for E-type BB mount.

MATERIAL: Harden steel
SPEC: ISCG or ISCG-05
FIX: 32T - 38T
OPTION: ADP-N



THRU AXLE

QUICK RELEASE

SEAT CLAMP

TOP CAP

HEADSETS PARTS

CRANK SET

CHAINING SYSTEM

ROLLER KIT SERIES

BMX SERIES

CHAINING PARTS

CHAIN GUIDE SYSTEM

BRAKE SYSTEM

SEATPOST

STEM SYSTEM

HANDLEBAR

AEROBAR SYSTEM

COMPUTER MOUNT

CAGE

ACCESSORIES

FITTING EQUIPMENT

PEDALS

CHAIN GUIDE SYSTEM

CUSTOM DESIGN AVAILABLE



THRU AXLE

QUICK RELEASE

SEAT CLAMP

TOP CAP

HEADSETS PARTS

CRANK SET

CHAINRING SYSTEM

ROLLER KIT SERIES

BMX SERIES

CHAINRING PARTS

CHAIN GUIDE SYSTEM

BRAKE SYSTEM

SEATPOST

STEM SYSTEM

HANDLEBAR

AEROBAR SYSTEM

COMPUTER MOUNT

CAGE

ACCESSORIES

FITTING EQUIPMENT

PEDALS



CH-MTS

50-01

Chain guide for MTB 1x9 or 1x10 drivetrain. With CH-EX plastic upper guard. BB mount version only.

MATERIAL: AL6061-T6
COLOR: Black
Includes spacers for chainline adjustable



CH-EMR

50-02

Roller type design. (For double chainring)

MATERIAL: AL6061-T6 CNC made
SPEC: ISCG or ISCG-05
FIX: 32T - 44T



CH-2GC

50-03

Roller type design. (for double chainring)

MATERIAL: AL6061-T6 CNC made
SPEC: ISCG or ISCG-05 or E-type
FIX: 32T - 44T



E-TYPE



ISCG



CH-09

50-04

Rotating & floating chain tensioner

CHAIN GUIDE SYSTEM

51



THRU AXLE

QUICK RELEASE

SEAT CLAMP

TOP CAP

HEADSETS PARTS

CRANK SET

CHAINRING SYSTEM

ROLLER KIT SERIES

BMX SERIES

CHAINRING PARTS

CHAIN GUIDE SYSTEM

BRAKE SYSTEM

SEATPOST

STEM SYSTEM

HANDLEBAR

AEROBAR SYSTEM

COMPUTER MOUNT

CAGE

ACCESSORIES

FITTING EQUIPMENT

PEDALS



CH-CLD

51-01

MATERIAL: AL6061-T6
SPEC: Clamp Ø34.9, Ø31.8, Ø28.6 mm
COLOR: Black



NEW

CH-FD-SH-MED2

51-02

Upper guide for single speed FD mount system frame.

MATERIAL: AL6061-T6 arm/nylon cage
SPEC: FD mount system
RANGE: 42T-68T
COLOR: As Order
WEIGHT: 30g



NEW

CH-FD-SHF

51-03

Inner guide for single speed FD mount system frame.

MATERIAL: AL6061-T6 arm/nylon cage
SPEC: FD mount system
RANGE: 42T-68T
COLOR: As Order
WEIGHT: 20g



CH-EX-FD

51-04

Low-profile, FD mount chain guard for 1X drivetrains. Alloy body, with a nylon guide that is easy to adjust and quiet on your chain.

MATERIAL: AL6066-T651 body / nylon cage
SPEC: FD mount system
RANGE: 32T - 58T
COLOR: Black
WEIGHT: 25g/set



ADP-N

51-05

Adapter for ISCG or ISCG05 to E-type BB mount.

MATERIAL: AL6061-T6
COLOR: As Order



CH-MINI UPPER-SV

51-06

Design for E-bike motor base, custom design available.

MATERIAL: Nylon

THRU AXLE

QUICK
RELEASE

SEAT CLAMP

TOP CAP

HEADSETS
PARTS

CRANK SET

CHAINRING
SYSTEMROLLER KIT
SERIES

BMX SERIES

CHAINRING
PARTSCHAIN GUIDE
SYSTEM

BRAKE SYSTEM

SEATPOST

STEM SYSTEM

HANDLEBAR

AEROBAR
SYSTEMCOMPUTER
MOUNT

CAGE

ACCESSORIES

FITTING
EQUIPMENT

PEDALS

**CH-CM2**

52-01

Chain guide for MTB 1x9 or
1x10 drivetrain.
With CH-EX plastic upper guard.

MATERIAL: AL6061-T6
DIA: Ø34.9 With adapter to Ø31.8
COLOR: Black
Chainline adjustable

**CH-CM1-E**

52-02

Chain guard for 1 by 9, 10, 11 speed.
With plastic upper guard.
Easy to set up the top guide position.

MATERIAL: AL6061-T6
DIA: Ø34.9 or Ø31.8
COLOR: Black
WEIGHT: 44g/set

**CH-CM1**

52-03

Chain guard for 1 by 9, 10, 11 speed.
With plastic upper guard.

MATERIAL: AL6061-T6
DIA: Ø34.9 With adapter to Ø31.8
COLOR: Black

**CH-1042E**

52-04

Design for 1x seattube mount system
drivetrain with small size plastic cage to
avoid chain drop for 1 by 9, 10, 11, 12
speed.

MATERIAL: AL6061-T6 forged
SPEC: Seattube Ø34.9 / Ø31.8
COLOR: As Order

**CH-CM4-E**

52-05

Chain guard for 1 by 9, 10, 11 speed.
With plastic upper guard.
Easy to set up the top guide position.

MATERIAL: AL6061-T6
DIA: Ø34.9 or Ø31.8
COLOR: Black
WEIGHT: 58.5g/set





THRU AXLE

QUICK RELEASE

SEAT CLAMP

TOP CAP

HEADSETS PARTS

CRANK SET

CHAINRING SYSTEM

ROLLER KIT SERIES

BMX SERIES

CHAINRING PARTS

CHAIN GUIDE SYSTEM

BRAKE SYSTEM

SEATPOST

STEM SYSTEM

HANDLEBAR

AEROBAR SYSTEM

COMPUTER MOUNT

CAGE

ACCESSORIES

FITTING EQUIPMENT

PEDALS



BRK-AERO-V730-CNC

53-01

Fits GIANT® PROPEL.
Direct mount aero V brake.
Liner spring adjuster system.
Quick adjuster for different rim width.

MATERIAL: AL6061-T6
BRAKE SHOES: SWISS STOP® brake shoes
COLOR: As Order
WEIGHT: 260.5g/bike



V3L-BRAKE

53-02

Change from coil spring to liner spring balance adjustable.

MATERIAL: AL7075-T6 full CNC made
WEIGHT: 150g/wheel
COLOR: Sand blast anodize



JULY-7905-CNC

53-03

MATERIAL: AL6066-T6 CNC made
BRAKE SHOES: CNC cassette
BOLT: Ti-64 main bolt
DIMENSION: C-C 39-51mm
OPTION: SWISS STOP® carbon rim pads available
COLOR: Polish anodize
WEIGHT: 210g/bike
SHIMANO® DURA-ACE 297g/bike
SRAM® RED 240g/bike



THRU AXLE

QUICK
RELEASE

SEAT CLAMP

TOP CAP

HEADSETS
PARTS

CRANK SET

CHAINRING
SYSTEMROLLER KIT
SERIES

BMX SERIES

CHAINRING
PARTSCHAIN GUIDE
SYSTEM

BRAKE SYSTEM

SEATPOST

STEM SYSTEM

HANDLEBAR

AEROBAR
SYSTEMCOMPUTER
MOUNT

CAGE

ACCESSORIES

FITTING
EQUIPMENT

PEDALS

**CAMP-97C-L**

54-01

MATERIAL: AL6066-T6 CNC made
DIMENSION: C-C 47-57mm
WEIGHT: 367g/bike

**CAMP-97C-R**

54-02

Reversed.

MATERIAL: AL6066-T6 CNC made
DIMENSION: C-C 39-51mm (+2mm than normal)
WEIGHT: 310g/bike



THRU AXLE

QUICK
RELEASE

SEAT CLAMP

TOP CAP

HEADSETS
PARTS

CRANK SET

CHAINRING
SYSTEMROLLER KIT
SERIES

BMX SERIES

CHAINRING
PARTSCHAIN GUIDE
SYSTEM

BRAKE SYSTEM

SEATPOST

STEM SYSTEM

HANDLEBAR

AEROBAR
SYSTEMCOMPUTER
MOUNT

CAGE

ACCESSORIES

FITTING
EQUIPMENT

PEDALS

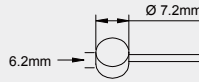

V3L-LEVER

55-01

For V-brake.
Three finger.

MATERIAL: AL6066-T6 full CNC made
WEIGHT: 70g/pair
COLOR: Sand blast anodize
BAR: Ø24mm with Ø22.2 Shim

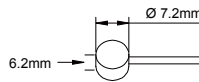

CT32-LEVER

55-02

For canti & caliper brake.
Two finger.

MATERIAL: AL6066-T6 full CNC made
LEVER RANGE: 102mm
WEIGHT: 85g/pair
COLOR: Sand blast anodize
BAR: Ø24mm with Ø22.2 Shim

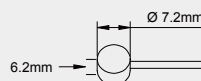

CT3L-LEVER

55-03

For canti & caliper brake.
Three finger.

MATERIAL: AL6066-T6 full CNC made
WEIGHT: 70g/pair
COLOR: Sand blast anodize
BAR: Ø24mm with Ø22.2 Shim



THRU AXLE

QUICK
RELEASE

SEAT CLAMP

TOP CAP

HEADSETS
PARTS

CRANK SET

CHAINRING
SYSTEMROLLER KIT
SERIES

BMX SERIES

CHAINRING
PARTSCHAIN GUIDE
SYSTEM

BRAKE SYSTEM

SEATPOST

STEM SYSTEM

HANDLEBAR

AEROBAR
SYSTEMCOMPUTER
MOUNT

CAGE

ACCESSORIES

FITTING
EQUIPMENT

PEDALS

**CAS+5**

56-01

Angle adjustable brake shoes.

MATERIAL: AL6061-T6 CNC made
SPEC: +5mm for better clear front brake
OPTION: 1. AMISHA® dark blue
 2. SWISS STOP® yellow king
 3. SWISS STOP® green

**CAS-5**

56-02

Angle adjustable brake shoes.

MATERIAL: AL6061-T6 CNC made
SPEC: -5mm for better clear rear brake
OPTION: 1. AMISHA® dark blue
 2. SWISS STOP® yellow king
 3. SWISS STOP® green

**CAS-1**

56-03

MATERIAL: AL6061-T6 CNC made
BOLT: Ti-64 SHIMANO® system
WEIGHT: 30g/set
OPTION: 1. AMISHA® dark blue
 2. SWISS STOP® yellow king
 3. SWISS STOP® green
 4. Ti-64 bolt

**CAS-62C**

56-04

**For canti brake.
Angle adjustable brake shoes.**

MATERIAL: Forged with CNC made
OPTION: AMISHA® dark blue

**CANTI-3C**

56-05

**With oval pads hold design.
With AMISHA® dark blue brake shoes.**

OPTION: SWISS STOP® pads
 CNC cas+5 holder for front
 CNC cas-5 holder for rear

Non adjustable spring**12-CX**

56-06

Canti brake hanger for fork.**COLOR:** As Order



THRU AXLE

QUICK
RELEASE

SEAT CLAMP

TOP CAP

HEADSETS
PARTS

CRANK SET

CHAINRING
SYSTEM

ROLLER KIT
SERIES

BMX SERIES

CHAINRING
PARTS

CHAIN GUIDE
SYSTEM

BRAKE SYSTEM

SEATPOST

STEM SYSTEM

HANDLEBAR

AEROBAR
SYSTEM

COMPUTER
MOUNT

CAGE

ACCESSORIES

FITTING
EQUIPMENT

PEDALS



- 
- THRU AXLE
- QUICK RELEASE
- SEAT CLAMP
- TOP CAP
- HEADSETS PARTS
- CRANK SET
- CHAINRING SYSTEM
- ROLLER KIT SERIES
- BMX SERIES
- CHAINRING PARTS
- CHAIN GUIDE SYSTEM
- BRAKE SYSTEM

NEW
SPA-DP

58-01

Lightweight design and precision manufacturing.
More drop options available

Diameter: 30.9 or 31.6
Drop options: 100/125/150/175/200mm
WEIGHT: 482g (OD 31.6 / 100mm)
Internal cable routing.



DROPPER LEVER



SIZE

- 30.9 or 31.6 x T100
- 30.9 or 31.6 x T125
- 30.9 or 31.6 x T150
- 30.9 or 31.6 x T175
- 30.9 or 31.6 x T200

SEATPOST

- STEM SYSTEM
- HANDLEBAR
- AEROBAR SYSTEM
- COMPUTER MOUNT
- CAGE
- ACCESSORIES
- FITTING EQUIPMENT
- PEDALS



NEW
SPA-SDP

58-02

Simplify design and precision manufacturing. Adjustable seat height.

MATERIAL: AL6061-T6/AL7075-T651
Diameter: 30.9 or 31.6
Drop: 150mm
OFFSET: 18mm
WEIGHT: 605.5g

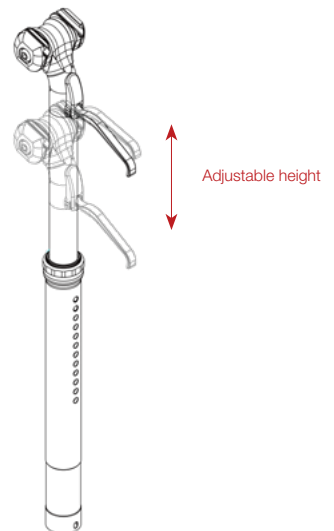



THRU AXLE

QUICK RELEASE

SEAT CLAMP

TOP CAP

HEADSETS PARTS

CRANK SET

CHAINRING SYSTEM

ROLLER KIT SERIES

BMX SERIES

CHAINRING PARTS

CHAIN GUIDE SYSTEM

BRAKE SYSTEM

SEATPOST

STEM SYSTEM

HANDLEBAR

AEROBAR SYSTEM

COMPUTER MOUNT

CAGE

ACCESSORIES

FITTING EQUIPMENT

PEDALS



59-01

SPA-35A

MATERIAL: 3D forged AL6061-T6
SPEC: Ø31.8 or Ø34.9mm
LENGTH: 450 or 600 or 700mm
OFFSET: 20mm
WEIGHT: 626g (Ø34.9x450mm)



59-02

SPA-SL7

Aluminum tube with cold drawn process, easy of adjustment and lightweight and stiffness.

MATERIAL: AL7050-T73
SPEC: Ø34 x 630L
OFFSET: 0mm
WEIGHT: 395g
COLOR: Sand blast anodize



59-03

NEW SPA-SF1

Lightweight Aluminum Tube

MATERIAL: Clamp base: Steel
 Tube: AL6061-T6
SPEC: Ø31.8 x 610L
THICKNESSES: 2.5T
WEIGHT: 605g
COLOR: Clamp base: ED/Black
 Tube: Sand blast anodized



THRU AXLE

QUICK
RELEASE

SEAT CLAMP

TOP CAP

HEADSETS
PARTS

CRANK SET

CHAINRING
SYSTEMROLLER KIT
SERIES

BMX SERIES

CHAINRING
PARTSCHAIN GUIDE
SYSTEM

BRAKE SYSTEM

SEATPOST

STEM SYSTEM

HANDLEBAR

AEROBAR
SYSTEMCOMPUTER
MOUNT

CAGE

ACCESSORIES

FITTING
EQUIPMENT

PEDALS



The upper and lower clamps, made of carbon fiber, are specifically designed to protect the saddle rail. The contact area between the lower clamp and the rail is enlarged to free the saddle rail from deformation.

**SHIM-1012** BEST SELLER 60-01**MATERIAL:** AL6061-T6

SPEC: OD Ø30.0 x ID Ø27.2 x (H)100mm
 OD Ø30.2 x ID Ø27.2 x (H)100mm
 OD Ø30.6 x ID Ø27.2 x (H)100mm
 OD Ø30.9 x ID Ø27.2 x (H)100mm
 OD Ø31.6 x ID Ø27.2 x (H)100mm
 OD Ø33.9 x ID Ø30.9 x (H)110mm
 OD Ø34.9 x ID Ø30.9 x (H)110mm
 OD Ø33.9 x ID Ø31.6 x (H)110mm
 OD Ø34.9 x ID Ø31.6 x (H)110mm
 OD Ø40.0 x ID Ø33.9 x (H)120mm
 OD Ø40.0 x ID Ø34.9 x (H)120mm

COLOR: As Order**SHIM-SLEEVE-NH** 60-02**MATERIAL:** AL6061-T6

SPEC: As Order
LENGTH: As Order

**SPC-SL3**
SPC-SL3-DI2 60-03**MATERIAL:** One piece UD Carbon fiber**SADDLE CLAMP:** Carbon clamp protect
Carbon rail**SPEC:** Ø27.2 or Ø30.9 or Ø31.6mm**LENGTH:** 350 or 400mm**OFFSET:** 0mm**WEIGHT:** 190g/pcs (Ø31.6x350mm)**OPTION:** SPC-SL3-DI2 (with SHIMANO® seatpost battery collar)**SPC-21**
SPC-21-DI2 60-04**MATERIAL:** UD Carbon fiber**SPEC:** Ø27.2 or Ø30.9 or Ø31.6mm**LENGTH:** 350 or 400mm**OFFSET:** 20mm**WEIGHT:** 200g/pcs (Ø31.6x350mm)**OPTION:** SPC-21-DI2 (with SHIMANO® seatpost battery collar)**EFBE**
PRÜFTECHNIK

P1206092 / P1206093

Pass overload 300 kg



ADP-DI2-27.2



ADP-DI2-31.6

ADP-DI2-27.2
ADP-DI2-31.6 60-05

SHIMANO® DI2 seatpost battery collar.
 With grinding paper, alcohol wipe, glue.

MATERIAL: AL6061-T6**SPEC:** ADP-DI2-27.2 for seatpost I.D. Ø22.2mm

ADP-DI2-31.6 for seatpost I.D. Ø27.2mm

Seatpost I.D. must be round

ADP-DI2 O.D. Customer design available

WEIGHT: 16g/pcs (for Ø27.2)

28.5g/pcs (for Ø31.6)

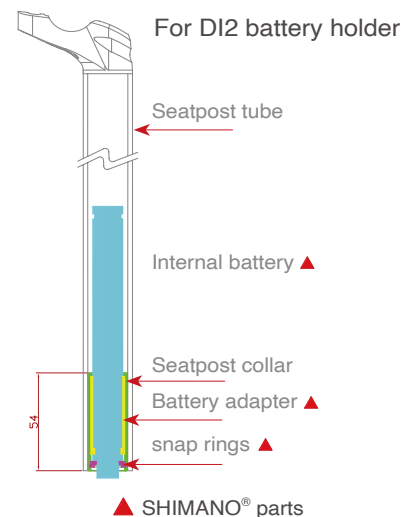



Better handling and reduced probability of deformation.



EFBE
PRÜFTECHNIK

P1306487 / P1306488 / P1306489

STEM-LB35A

61-01

Fork stack height 40mm.
Ø31.8mm handlebar clamp Ø35mm.

MATERIAL: AL6066-T6

SPEC: 80 - 130mm

ANGLE: ±8°

WEIGHT: 142g/pcs (110mm)

OPTION: Titanium bolt

INCLUDING: 1. SHIM-3x2 OD Ø35 x ID Ø31.8 x 60mm
2. SHIM-CC OD Ø31.8 x ID Ø28.6 x 38mm



SHIM-CC-AL

61-02

Alloy spacer.

MATERIAL: AL6061

SPEC: OD Ø31.8 x ID Ø28.6mm

H: 38mm



SHIM-3X2-AL

61-03

Alloy spacer.

MATERIAL: AL6061

SPEC: OD Ø35 x ID Ø31.8mm

WIDTH: 45mm



SHIM-3x2

61-04

Bar bore adapter also reduces vibrations.

MATERIAL: Carbon

SPEC: OD Ø35 x ID Ø31.8 x 60mm

OD Ø31.8 x ID Ø26 x 60mm

OD Ø31.8 x ID Ø25.4 x 60mm



SHIM-CC

61-05

For fork stem tube.

MATERIAL: Carbon UD

SPEC: OD Ø31.8 x ID Ø28.6mm

H: 38mm



AC-31.8-36-H

61-06

Carbon spacer.

SPEC: OD Ø36 x ID Ø32mm

H: As Order

COLOR: 3K, UD



AC-36-H

61-07

Carbon spacer.

SPEC: OD Ø36 x ID Ø28.6mm

H: As Order

COLOR: 3K, UD



TK-T032A

61-08

**For Ø31.8mm fork.
With stainless steel bolt.**

MATERIAL: AL6061-T6

WEIGHT: 11.2g/pcs



TK-032SW

61-09

For carbon Ø31.8mm fork.

SPEC: Ø27.5 - Ø27.7mm with shim

LENGTH: 45mm

WEIGHT: 44g/pcs



STAR NUT-29

61-10

For Ø31.8mm alloy / Cr-Mo fork.

SPEC: Ø28.8mm



THRU AXLE

QUICK
RELEASE

SEAT CLAMP

TOP CAP

HEADSETS
PARTS

CRANK SET

CHAINRING
SYSTEM

ROLLER KIT
SERIES

BMX SERIES

CHAINRING
PARTS

CHAIN GUIDE
SYSTEM

BRAKE SYSTEM

SEATPOST

STEM SYSTEM

HANDLEBAR

AEROBAR
SYSTEM

COMPUTER
MOUNT

CAGE

ACCESSORIES

FITTING
EQUIPMENT

PEDALS

**WE CAN REACH YOUR IDEAL DESIGN
BASED ON OUR STEM EXTRUSION MATERIAL DATA.**



WE MAKE STEM(CNC)



NEW
STEM-KIX

62-01

Intergrate with BOSCH® KIOX BES3 monitor.

Compatible with TOKEN® C-BOX integrated cable headset system.

Include TOP-CAP and monitor adaptor.

MATERIAL: Alloy

Angle: +12°

LENGTH: 90/110mm



NEW
STEM-KIX-LT

62-02

Intergrate with BOSCH® KIOX BES3 monitor.

Compatible with TOKEN® C-BOX integrated cable headset system.

Include TOP-CAP, monitor adaptor, and front light adaptor. (Light not include.)

MATERIAL: Alloy

Angle: +12°

LENGTH: 90/110mm

**Front light adapter.
Compatible with
SUPERNOVA®
starstream series**



THRU AXLE

QUICK
RELEASE

SEAT CLAMP

TOP CAP

HEADSETS
PARTS

CRANK SET

CHAINRING
SYSTEM

ROLLER KIT
SERIES

BMX SERIES

CHAINRING
PARTS

CHAIN GUIDE
SYSTEM

BRAKE SYSTEM

SEATPOST

STEM SYSTEM

HANDLEBAR

AEROBAR
SYSTEM

COMPUTER
MOUNT

CAGE

ACCESSORIES

FITTING
EQUIPMENT

PEDALS



STEM-LB017

63-01

**Fork stack height 40mm Ø31.8mm.
Handlebar clamp Ø31.8mm.**

MATERIAL: AL6066-T6
SPECS: Diameter Handlebar Ø31.8mm
 Steerer Tube Ø31.8mm
 Fork Stack Height 40mm
LENGTH: 80 - 120mm
ANGLE: ±17°
WEIGHT: 154g/pcs (140mm)
OPTION: Titanium bolt



STEM-LB1

63-02

MATERIAL: AL6066-T6
SPECS: Diameter handlebar Ø31.8mm
 Steerer Tube Ø28.6mm
 Fork Stack Height 40mm
LENGTH: 50 - 140mm
ANGLE: ±6°
WEIGHT: 128g/pcs (120mm)
OPTION: Titanium bolt

EFBE
PRÜFTECHNIK

P1306490 / P1306491 / P1306492



STEM-32-ST

63-03

MATERIAL: AL6061-T6
SPECS: Handlebar clamp Ø31.8mm
 Steerer tube Ø28.6mm
ANGLE: 0°
LENGTH: 35mm
WEIGHT: 103g/pcs
W/O: Top cap



SM-DH35

63-04

MATERIAL: AL6066-T6
DIRECT MOUNT: Boxxer
SPEC: Handlebar clamp Ø35mm
 Offset height 25mm
WEIGHT: 170g/pcs
OPTION: SHIM-3x2 (Ø35 x Ø31.8mm)



THRU AXLE

QUICK RELEASE

SEAT CLAMP

TOP CAP

HEADSETS PARTS

CRANK SET

CHAINRING SYSTEM

ROLLER KIT SERIES

BMX SERIES

CHAINRING PARTS

CHAIN GUIDE SYSTEM

BRAKE SYSTEM

SEATPOST

STEM SYSTEM

HANDLEBAR

AEROBAR SYSTEM

COMPUTER MOUNT

CAGE

ACCESSORIES

FITTING EQUIPMENT

PEDALS

HANDLEBAR

- 
- THRU AXLE
- QUICK RELEASE
- SEAT CLAMP
- TOP CAP
- HEADSETS PARTS
- CRANK SET
- CHAINRING SYSTEM
- ROLLER KIT SERIES
- BMX SERIES
- CHAINRING PARTS
- CHAIN GUIDE SYSTEM
- BRAKE SYSTEM
- SEATPOST
- STEM SYSTEM
- HANDLEBAR**
- AEROBAR SYSTEM
- COMPUTER MOUNT
- CAGE
- ACCESSORIES
- FITTING EQUIPMENT
- PEDALS



NEW

HB-MBR-780-SSM

64-01

Handlebar with light holder. compatible with SUPERNOVA® Starstream mini.

MATERIAL: AL6061-T6
SPEC: Ø31.8 x W780mm
RISE: 20mm
BACK SWEEP: 9 degree
UP SWEEP: 5 degree

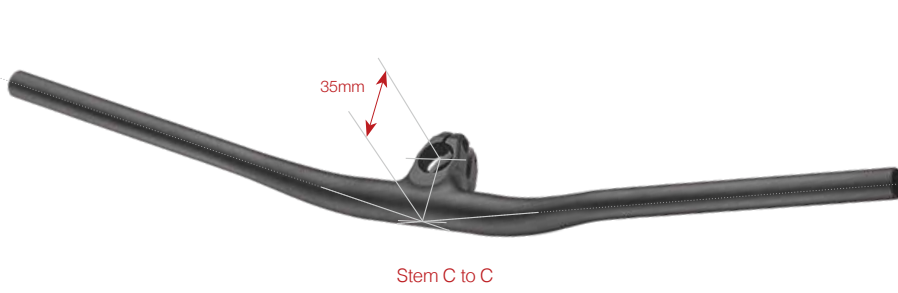

PATENTED

HB-STB-M35-MR02

64-02

MATERIAL: AL-6061-T6
SPEC: Stem length 35mm
 Bar width 800mm
 For Ø28.6 Steer tube
RISE: 20mm
BACK SWEEP: 8 degree
UP SWEEP: 5 degree

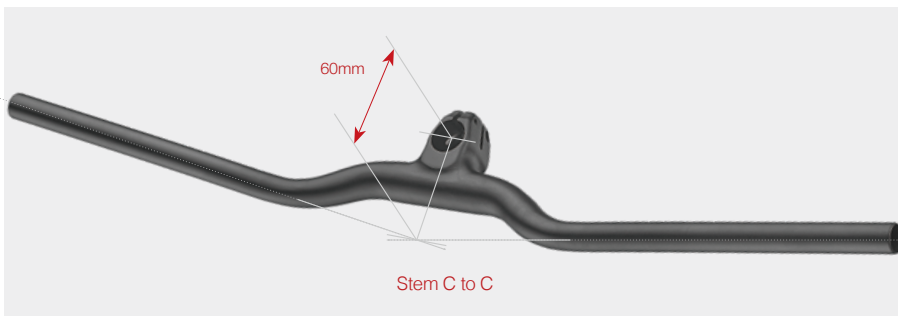

PATENTED

HB-STB-M35-MR060

64-03

MATERIAL: AL-6061-T6
SPEC: Stem length 60mm,
 Bar width 800mm, For Ø28.6 Steer tube
RISE: 15mm
BACK SWEEP: 8 degree
UP SWEEP: 5 degree

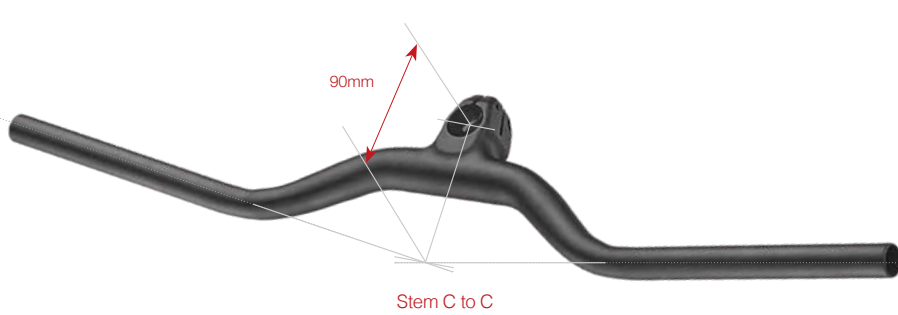

PATENTED

HB-STB-M35-MR090

64-04

MATERIAL: AL-6061-T6
SPEC: Stem length 90mm
 Bar width 800mm, For Ø28.6 Steer tube
RISE: 5mm
BACK SWEEP: 8 degree
UP SWEEP: 5 degree



HB-MBR-780/32 HB-MBR-780/32-H (600kg)

64-05

MATERIAL: Carbon fiber (3K or UD)
SPEC: Ø31.8 x W780mm
RISE: 20mm
BACK SWEEP: 9 degree
UP SWEEP: 5 degree
WEIGHT: 280g/pcs±10g
OPTION: HB-MBR-780 / 32-H
WEIGHT: 320g/pcs±10g
OVERLOAD: 600kg for DH use

EFBE
 PRÜFTECHNIK

P1306490 / P1306491 /
 P1306492

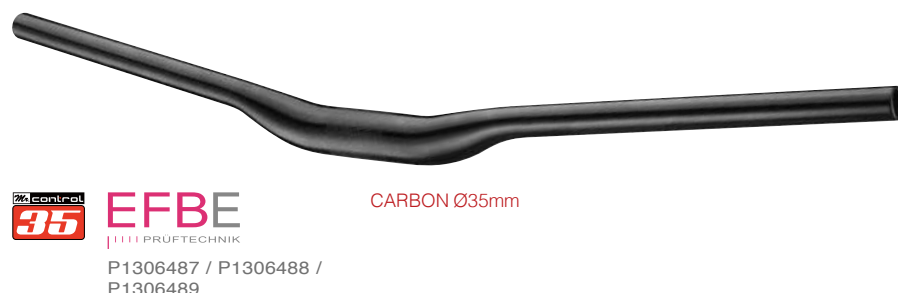

HB-MBR-780/35 HB-MBR-780/35-H (600kg)

64-06

MATERIAL: Carbon fiber (3K or UD)
SPEC: Ø35 x W780mm
RISE: 20 / 30mm
BACK SWEEP: 9 degree
UP SWEEP: 5 degree
WEIGHT: 285g/pcs±10g
OPTION: HB-MBR-780 / 35-H
WEIGHT: 325g/pcs±10g
OVERLOAD: 600kg for DH use

control 35 **EFBE**
 PRÜFTECHNIK

P1306487 / P1306488 /
 P1306489



THRU AXLE

QUICK RELEASE

SEAT CLAMP

TOP CAP

HEADSETS PARTS

CRANK SET

CHAINRING SYSTEM

ROLLER KIT SERIES

BMX SERIES

CHAINRING PARTS

CHAIN GUIDE SYSTEM

BRAKE SYSTEM

SEATPOST

STEM SYSTEM

HANDLEBAR

AEROBAR SYSTEM

COMPUTER MOUNT

CAGE

ACCESSORIES

FITTING EQUIPMENT

PEDALS

NEW

HB-STB-M1-SSM

65-01

Custom CNC made handlebar integrated light holder with SUPERNOVA® Starstream mini. (Light not included.)

MATERIAL: AL6061-T6
STEM ANGLE: -10°
STEM LENGTH: 70 / 90 / 110mm
WIDTH (HOOD TO HOOD)/WIDTH(DROP TO DROP): about 380 / 413 ; 400 / 433 ; 420 / 453 ; 440 / 473 ; 460 / 493 (mm)
STEERER TUBE: Ø28.6mm
FORK STACK HEIGHT: 40mm
FLARE: 12°
DROP: 120mm
REACH: 85mm
WEIGHT: about 530g (W: 400mm; Stem L: 90mm)
HEADSET COMPATIBLE WITH TOKEN® A-BOX
CODE: TK155P



Integrated light and top cap.

SUPERNOVA® Starstream mini
 Headset compatible with TOKEN® A-BOX Code: TK155P

HB-STB-M1

65-02

MATERIAL: AL6061-T6
STEM ANGLE: -10°
STEM LENGTH: 70 / 90 / 110mm
WIDTH (HOOD TO HOOD)/WIDTH(DROP TO DROP): about 380 / 413 ; 400 / 433 ; 420 / 453 ; 440 / 473 ; 460 / 493 (mm)
STEERER TUBE: Ø28.6mm
FORK STACK HEIGHT: 40mm
FLARE: 12°
DROP: 120mm
REACH: 85mm
WEIGHT: about 530g (W: 400mm; Stem L: 90mm)
HEADSET COMPATIBLE WITH TOKEN® A-BOX
CODE: TK155P



Integrated extension mount and top cap.

HB-RBA-0209

65-03

MATERIAL: AL6061-T6
SPEC: Ø31.8 x W360mm / 380mm / 400mm / 420mm / 440mm (C-C)
INWARD: 10degrees
FLARE: 10degrees
DROP: 115mm
REACH: 75mm
BAR TYPE: Compact bend
WEIGHT: 297g/pcs±10g

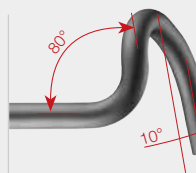

Innovation version
HB-RBA-0209

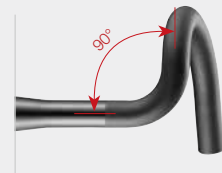

Current type



THRU AXLE

QUICK
RELEASE

SEAT CLAMP

TOP CAP

HEADSETS
PARTS

CRANK SET

CHAINRING
SYSTEMROLLER KIT
SERIES

BMX SERIES

CHAINRING
PARTSCHAIN GUIDE
SYSTEM

BRAKE SYSTEM

SEATPOST

STEM SYSTEM

HANDLEBAR

AEROBAR
SYSTEMCOMPUTER
MOUNT

CAGE

ACCESSORIES

FITTING
EQUIPMENT

PEDALS

**EFBE**

PRÜFTECHNIK

P1206089 / P1206090
P1206091**HB-RBC1**

66-01

MATERIAL: Carbon fiber
SPEC: Ø31.8 x W400mm / 420mm / 440mm (C-C)
DROP: 130mm
REACH: 80mm
BAR TYPE: Anatomic bend
WEIGHT: 216g/pcs±10g

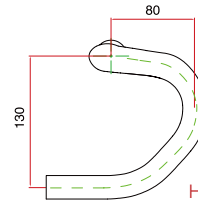

HB-RBC1 Anatomic bend

**HB-RBA11**

66-02

Rise 15mm, could provide different riding posture for rider.

MATERIAL: AL6061-T6
SPEC: Ø31.8 x W360mm / 380mm / 400mm / 420mm (C-C)
DROP: 125mm
REACH: 80mm
BAR TYPE: Anatomic bend
WEIGHT: 310g/pcs±10g

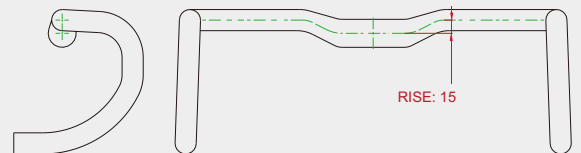

RISE: 15

**HB-RBA12**

66-03

Provides a reduced-size version for the female market.

MATERIAL: AL6061-T6
SPEC: Ø31.8 x 380mm / 400mm / 420mm (C-C)
DROP: 125mm
REACH: 75mm
BAR TYPE: Compact bend
WEIGHT: 310g/pcs±10g



THRU AXLE

QUICK RELEASE

SEAT CLAMP

TOP CAP

HEADSETS PARTS

CRANK SET

CHAINRING SYSTEM

ROLLER KIT SERIES

BMX SERIES

CHAINRING PARTS

CHAIN GUIDE SYSTEM

BRAKE SYSTEM

SEATPOST

STEM SYSTEM

HANDLEBAR

AEROBAR SYSTEM

COMPUTER MOUNT

CAGE

ACCESSORIES

FITTING EQUIPMENT

PEDALS



TRI-ORG-12H

67-01

Armrest with adapter for height adjustment.

MATERIAL: AL6061-T6 CNC made

SPEC: For Ø31.8mm handlebar with TUB-S

OPTION: ALLOY EXTENSION TUBE:

TUB-S, TUB-J, TUB-S1, TUB-S2

3K OR UD CARBON EXTENSION TUBE:

TUB-S-C, TUB-J-C, TUB-I-C, TUB-S2-C

Include adapter 20 / 40 / 60mm



TRI-ORG-12F

67-02

Classic design armrest.

MATERIAL: AL6061-T6 forged CNC made

SPEC: For Ø31.8mm handlebar with TUB-S

OPTION: ALLOY EXTENSION TUBE:

TUB-S, TUB-J, TUB-S1, TUB-S2

3K OR UD CARBON EXTENSION TUBE:

TUB-S-C, TUB-J-C, TUB-I-C, TUB-S2-C



TRI-MINIBAR

67-03

P.A.T ED

For MTB and Road

SPEC: 44mm rise up

From handle position

For Ø31.8mm handlebar



TRI-PA1.75

67-04

P.A.T ED

Armrest adjustable main bar.
1.75 rise up from handle.

MATERIAL: AL6061-T6

SPEC: For Ø31.8mm handlebar position with TUB-S

OPTION: ALLOY EXTENSION TUBE:

TUB-S, TUB-J, TUB-S1, TUB-S2

3K OR UD CARBON EXTENSION TUBE:

TUB-S-C, TUB-J-C, TUB-I-C, TUB-S2-C



THRU AXLE

QUICK
RELEASE

SEAT CLAMP

TOP CAP

HEADSETS
PARTS

CRANK SET

CHAINRING
SYSTEMROLLER KIT
SERIES

BMX SERIES

CHAINRING
PARTSCHAIN GUIDE
SYSTEM

BRAKE SYSTEM

SEATPOST

STEM SYSTEM

HANDLEBAR

AEROBAR
SYSTEMCOMPUTER
MOUNT

CAGE

ACCESSORIES

FITTING
EQUIPMENT

PEDALS

**TRI-BR120P**

68-01

For triathlon extension bars bridge.
With Ø26mm computer tube.

WIDTH: min.85mm-max.105mm,
5mm pitch adjustable width
Maximum 20mm

MATERIAL: Nylon
WEIGHT: 54g/set

**WB-TT1**

68-02

Clamping the water bottle cage for triathlon bar.
Bundle for easy hold.

MATERIAL: AL6061-T6
WEIGHT: 30g/set

TUB-J

68-03

MATERIAL: AL6061-T6
ANGLE: 50 degree
LENGTH: 300mm
WEIGHT: 190g/pair

TUB-J

300mm

TUB-S2

68-04

MATERIAL: AL6061-T6
ANGLE: 17 degree
LENGTH: 310mm
WEIGHT: 147g/pair

TUB-S2

310mm

TUB-S

68-05

MATERIAL: AL6061-T6
ANGLE: 17 degree
LENGTH: 340mm
WEIGHT: 203.5g/pair

TUB-S

340mm

TUB-S1

68-06

MATERIAL: AL6061-T6
ANGLE: 17 degree
LENGTH: 180mm
WEIGHT: 117g/pair

TUB-S1

180mm

TUB-J-C

68-07

MATERIAL: Carbon fiber
Ø22.2 rest bar
ANGLE: 50 degree
LENGTH: 300mm
WEIGHT: 131g/pair
Finish Carbon 3K or Carbon UD

TUB-J-C

300mm

TUB-S2-C

68-08

MATERIAL: Carbon fiber
Ø22.2 rest bar
LENGTH: 310mm
ANGLE: 17 degree
WEIGHT: 120g/pair
Finish Carbon 3K or Carbon UD

TUB-S2-C

310mm

TUB-S-C

68-09

MATERIAL: Carbon fiber
Ø22.2 rest bar
ANGLE: 17 degree
LENGTH: 340mm
WEIGHT: 140g/pair
Finish Carbon 3K or Carbon UD

TUB-S-C

340mm

TUB-I-C

68-10

MATERIAL: Carbon fiber
Ø22.2 rest bar
ANGLE: 0 degree
LENGTH: 300mm
WEIGHT: 132g/pair
Finish Carbon 3K or Carbon UD

TUB-I-C

300mm

COMPUTER MOUNT

69



THRU AXLE

QUICK
RELEASE

SEAT CLAMP

TOP CAP

HEADSETS
PARTS

CRANK SET

CHAINRING
SYSTEM

ROLLER KIT
SERIES

BMX SERIES

CHAINRING
PARTS

CHAIN GUIDE
SYSTEM

BRAKE SYSTEM

SEATPOST

STEM SYSTEM

HANDLEBAR

AEROBAR
SYSTEM

COMPUTER
MOUNT

CAGE

ACCESSORIES

FITTING
EQUIPMENT

PEDALS





THRU AXLE

QUICK
RELEASE

SEAT CLAMP

TOP CAP

HEADSETS
PARTS

CRANK SET

CHAINRING
SYSTEMROLLER KIT
SERIES

BMX SERIES

CHAINRING
PARTSCHAIN GUIDE
SYSTEM

BRAKE SYSTEM

SEATPOST

STEM SYSTEM

HANDLEBAR

AEROBAR
SYSTEMCOMPUTER
MOUNT

CAGE

ACCESSORIES

FITTING
EQUIPMENT

PEDALS

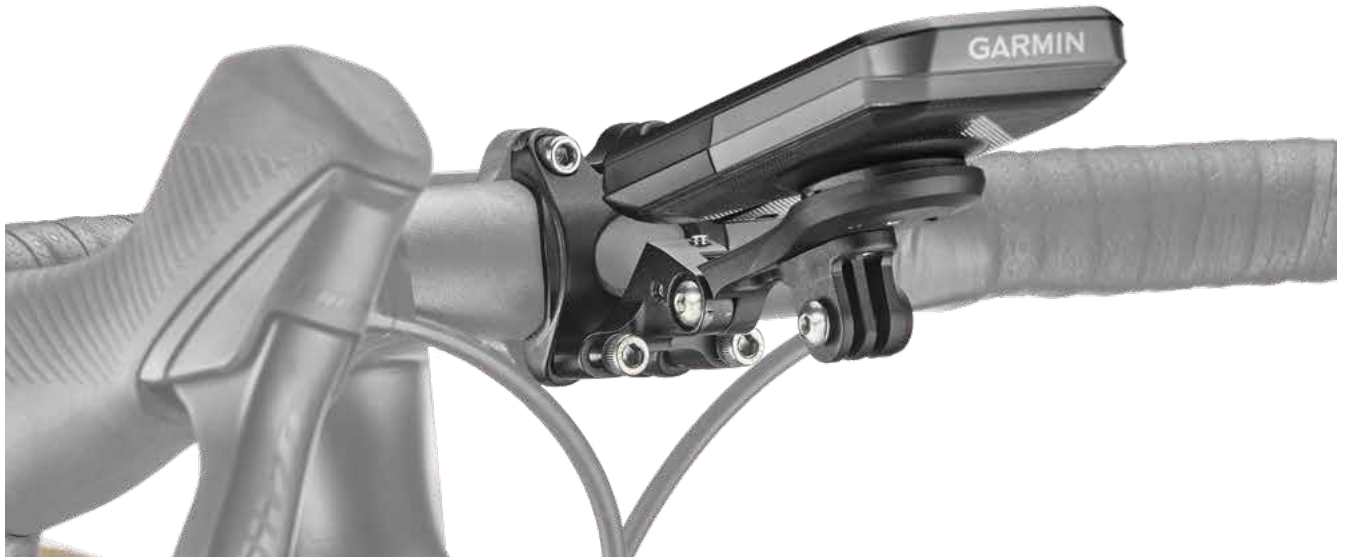

INSIDE FACTORY LABORATORY FATIGUE TEST

Impact 150kg/f at the stem/handlebar.

Load of 1,000 grams at the extension arm and run for 100,000 times.



AVAILABLE IN DIFFERENT CYCLING COMPUTER AND CAMERA / LIGHT MOUNT

Interchangeable trays:



GM1
(GARMIN® Edge)



Mio2
(MIO® Cyclo™)



BTN3
(Bryton® Rider™)



GAT5
(GIANT® NEOSTRACK)



WHO6
(WAHOO® ELEMNT)

NEW



HMD8
(HAMMERHEAD KAROO®)



GPO7
(GoPro®)



THRU AXLE

QUICK
RELEASE

SEAT CLAMP

TOP CAP

HEADSETS
PARTS

CRANK SET

CHAINRING
SYSTEMROLLER KIT
SERIES

BMX SERIES

CHAINRING
PARTSCHAIN GUIDE
SYSTEM

BRAKE SYSTEM

SEATPOST

STEM SYSTEM

HANDLEBAR

AEROBAR
SYSTEMCOMPUTER
MOUNT

CAGE

ACCESSORIES

FITTING
EQUIPMENT

PEDALS



Angle adjust serew.



Secondary fixing screw.

P.A.T.

Taiwan No.113206040 / 113206042

China No.202421339745.6 / 202421339739.0

NEW

AR-ADJ-GM1

71-01



Angle adjustable design.
5mm spacer style computer mount.
Fits 1-1/8" steerer tube.

Base / Extension arm

MATERIAL: AL6061-T6

Tray

MATERIAL: Nylon



GM-GRA

71-02

Computer mount for integrated bar stem.
Main arm angle adjustable.
Compatible with Garmin Edge 1050.

MATERIAL: AL 6061-T6

Extension arm / PA66

FEATURES: Extension arm angle adjustable.
Dual fixing bolt system.
Interchangeable tray system.



GM-GR-CX2

71-03

CNC bracket available in interchangeable trays.
Fit stem screw distance : 25mm- 34mm
Compatible with Garmin Edge 1050.

MATERIAL: Base / AL6061-T6

Extension arm / PA66

FEATURES: Extension arm angle adjustable.
Dual fixing bolt system.
Interchangeable tray system.

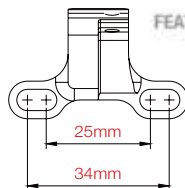

Fit stem screw distance



GR-MOUNT-SL-R

71-04

Best computer mount solution when use areo handlebar with barbore Ø31.8 stem.
Cap fit Giant® CONTACT SL AERO STEM and CONTACT SLR AERO STEM.
Compatible with Garmin Edge 1050.

MATERIAL: Cap / AL-6061-T6

Extension arm / PA66

FEATURES: Extension arm angle adjustable.
Dual fixing bolt system.
Interchangeable tray system.

Stem cap customsize available.





THRU AXLE

QUICK
RELEASE

SEAT CLAMP

TOP CAP

HEADSETS
PARTS

CRANK SET

CHAINRING
SYSTEMROLLER KIT
SERIES

BMX SERIES

CHAINRING
PARTSCHAIN GUIDE
SYSTEM

BRAKE SYSTEM

SEATPOST

STEM SYSTEM

HANDLEBAR

AEROBAR
SYSTEMCOMPUTER
MOUNT

CAGE

ACCESSORIES

FITTING
EQUIPMENT

PEDALS



GR-MOUNT-AEROLIGHT

72-01

Best computer mount solution when use aero handlebar with bar bore Ø31.8 stem.
Cap fit Giant® CONTACT AEROLIGHT STEM.
Compatible with Garmin Edge 1050.

MATERIAL: Cap / AL-6061-T6
Extension arm / PA66

FEATURES: Extension arm angle adjustable.
Dual fixing bolt system,
Interchangeable tray system.

Stem cap customize available.



GMX-MY23

72-02

Computer mount for integrated bar stem.
Main arm angle adjustable.
Compatible with Garmin Edge 1050.

MATERIAL: AL6061
WEIGHT: 46g/set
Not available in Japan



AC-MTB35

72-03

Clamping type for MTB and cyclocross cycling
computer mount.
Place cycling computer above the stem.

MATERIAL: AL6061
SPEC: Clamp Ø35mm with SHIM Ø31.8mm
WEIGHT: 39g/set



ADP-BCM-P

72-04

For handlebar cycling computer mount.
With removable GoPro® interface.
Simple and fast installation.
CNC bracket, available in interchangeable trays.
Compatible with Garmin Edge 1050.

MATERIAL: AL6061-T6
SPEC: Clamp Ø31.8mm
WEIGHT: 57g/set



ADP-RSCAP 73-01

P.A.T ED
OPTION: With GoPro® mount (-GO).
CNC bracket, available in interchangeable trays.

SCREW CENTER DISTANCE: 23 - 40mm
ANGLE ADJUSTABLE: 20°
WEIGHT: ADP-RSCAP: 33.5g/set (without adapter)
 ADP-RSCAP-GO: 42g/set (with adapter)

ADP-COMPGR 73-02

Computer mount of stem cap.
CNC bracket, available in interchangeable trays.

MATERIAL: AL6061-T6
SCREW CENTER DISTANCE: 11- 33mm
WEIGHT: 40g/set (with out adapter)

ADP-GM1-TT 73-03

For Triathlon armrest Ø22.2mm tube.
CNC bracket, available in interchangeable trays.

MATERIAL: AL6061-T6 body
 Plastic adapter
WEIGHT: 42.5g/set (without adapter)

TK-GM1-DX 73-04

Top cap cycling computer mount.
CNC bracket, available in interchangeable trays.

MATERIAL: AL6061-T6

THRU AXLE

QUICK RELEASE

SEAT CLAMP

TOP CAP

HEADSETS PARTS

CRANK SET

CHAINRING SYSTEM

ROLLER KIT SERIES

BMX SERIES

CHAINRING PARTS

CHAIN GUIDE SYSTEM

BRAKE SYSTEM

SEATPOST

STEM SYSTEM

HANDLEBAR

AEROBAR SYSTEM

COMPUTER MOUNT

CAGE

ACCESSORIES

FITTING EQUIPMENT

PEDALS



THRU AXLE

QUICK
RELEASE

SEAT CLAMP

TOP CAP

HEADSETS
PARTS

CRANK SET

CHAINRING
SYSTEMROLLER KIT
SERIES

BMX SERIES

CHAINRING
PARTSCHAIN GUIDE
SYSTEM

BRAKE SYSTEM

SEATPOST

STEM SYSTEM

HANDLEBAR

AEROBAR
SYSTEMCOMPUTER
MOUNT

CAGE

ACCESSORIES

FITTING
EQUIPMENT

PEDALS

**GM-GO (GoPro®)**

74-01

Compatible with GARMIN Edge® interface, for GoPro® mount.**MATERIAL:** Plastic**ADP-INT-GM1**

74-02

Computer mount for integrated bar stem.**MATERIAL:** AL6061-T6**OPTION:** GPO7 mount compatible**ADP-GMSP1**

74-03

Compatible for GoPro® for Ø31.6 seatpost. With Ø27.2 shim.**MATERIAL:** AL6061-T6 body**WEIGHT:** 59.5g/set (without adapter)**ADP-GPL**

74-04

GoPro® mount convert to light holder.**MATERIAL:** AL6061-T6



THRU AXLE

QUICK
RELEASE

SEAT CLAMP

TOP CAP

HEADSETS
PARTS

CRANK SET

CHAINRING
SYSTEMROLLER KIT
SERIES

BMX SERIES

CHAINRING
PARTSCHAIN GUIDE
SYSTEM

BRAKE SYSTEM

SEATPOST

STEM SYSTEM

HANDLEBAR

AEROBAR
SYSTEMCOMPUTER
MOUNT

CAGE

ACCESSORIES

FITTING
EQUIPMENT

PEDALS

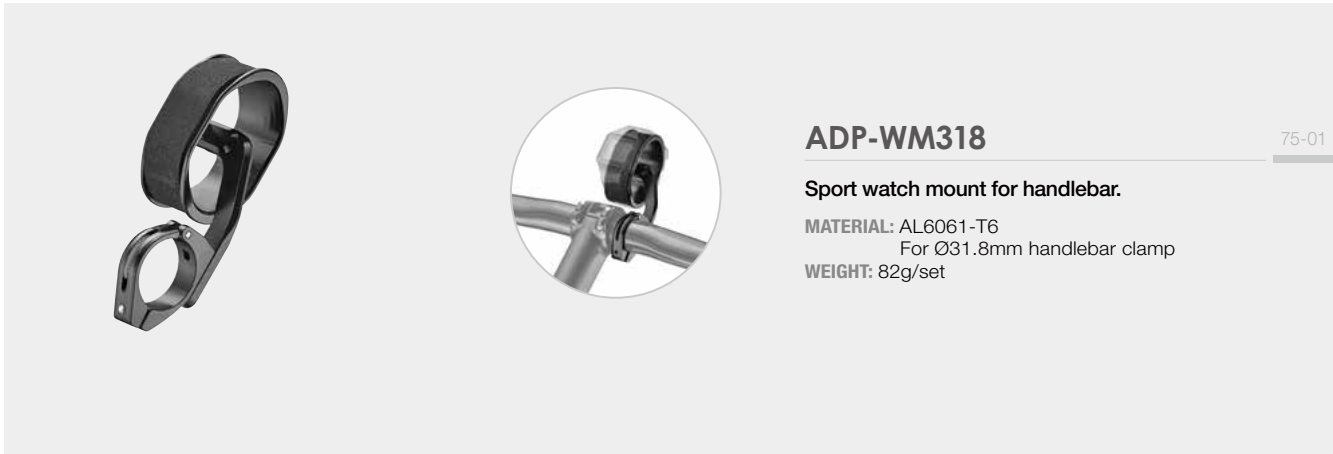

ADP-WM318

75-01

Sport watch mount for handlebar.

MATERIAL: AL6061-T6
For Ø31.8mm handlebar clamp
WEIGHT: 82g/set



ADP-ORG26-SI-L

ADP-ORG26-SI-L ADP-ORG26-R

75-02

Single clamp type with alloy extension bar.
Easy assembly shift on gravel bike.

SPEC: Ø31.8 x Ø22.2mm Extension bar
C-C: 52mm
COLOR: As Order

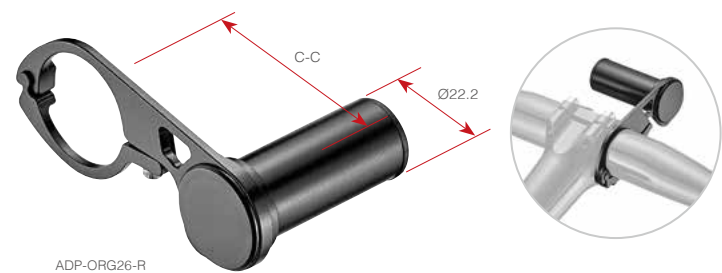

ADP-ORG26-R



ADP-3RL-2X32

75-03

Double clamp for Ø31.8 extension bar,
create extra space for bike packing gear.

MATERIAL: AL6061-T6
SPEC: Clamp Ø31.8 mm
TUBE: Ø31.8 x 200L



THRU AXLE

QUICK
RELEASE

SEAT CLAMP

TOP CAP

HEADSETS
PARTS

CRANK SET

CHAINRING
SYSTEMROLLER KIT
SERIES

BMX SERIES

CHAINRING
PARTSCHAIN GUIDE
SYSTEM

BRAKE SYSTEM

SEATPOST

STEM SYSTEM

HANDLEBAR

AEROBAR
SYSTEMCOMPUTER
MOUNT

CAGE

ACCESSORIES

FITTING
EQUIPMENT

PEDALS

**ADP-3R**

76-01

Alloy clamp & tube.**WITH SHIM:** R051 (Ø31.8 x Ø25.4mm x 11w)
R056 (Ø31.8 x Ø26mm x 11w)**SPEC:** Ø31.8 x Ø22.2mm**ADP-3RC**

76-02

Alloy clamp + Carbon tube.**WITH SHIM:** R051 (Ø31.8 x Ø25.4mm x 11w)
R056 (Ø31.8 x Ø26mm x 11w)**SPEC:** Ø31.8 x Ø22.2mm**ADP-3RL**

76-03

**Double alloy clamp with length 200mm tube.
Adjustable clamp spacing.****MATERIAL:** AL6061- T6**SPEC:** Ø31.8mm**TUBE:** Ø22.2 x 200L**WEIGHT:** 43g/ set**COLOR:** As Order**NEW****ADP-ORG32-SSM**

76-04

**Create extra space for handlebar. Integrated computer
mount and light. Adequate lighting. Angle adjustable.
Best provide for heat dissipation.
(Light not included.)****MATERIAL:** AL6061-T6**SPEC:** Ø31.8mm**W:** 58mm**WEIGHT:** 100g

Light holder compatible with SUPERNOVA® Starstream mini

**ADP-ORG26**

76-05

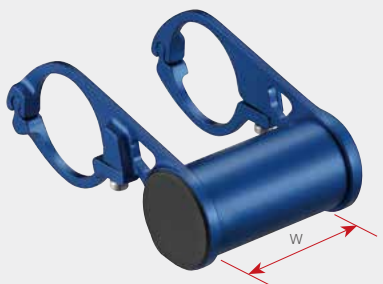
**Create extra space for handlebar.
Double clamp with Carbon tube Ø26mm.****MATERIAL:** AL6061-T6**SPEC:** Ø31.8mm**W:** 46mm / 59mm**WEIGHT:** 32g/set (46mm)**ADP-ORG26-A**

76-06

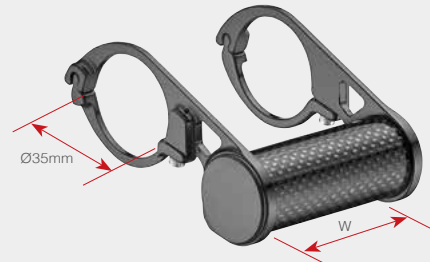
**Create extra space for handlebar.
Double clamp with AL6061-T6 tube Ø26mm.****MATERIAL:** AL6061-T6**SPEC:** Ø31.8mm**W:** 46mm / 59mm**WEIGHT:** 43g/set (46mm)**COLOR:** As Order**ADP-ORG26-35
ADP-ORG26-35-A**

76-07

**Create extra space for handlebar.
Double clamp with tube Ø26mm.****MATERIAL:** AL6061-T6 clamp

ADP-ORG26-35: 3K CARBON tube

ADP-ORG26-35-A: AL6061-T6 tube

SPEC: Ø35mm**W:** 46mm / 59mm



THRU AXLE

QUICK RELEASE

SEAT CLAMP

TOP CAP

HEADSETS PARTS

CRANK SET

CHAINRING SYSTEM

ROLLER KIT SERIES

BMX SERIES

CHAINRING PARTS

CHAIN GUIDE SYSTEM

BRAKE SYSTEM

SEATPOST

STEM SYSTEM

HANDLEBAR

AEROBAR SYSTEM

COMPUTER MOUNT

CAGE

ACCESSORIES

FITTING EQUIPMENT

PEDALS



NEW
ADP-KIOX-INT200

77-01

Compatible with KIOX Intuvia 200 display,
Allows angle and side adjustment for clear rider
display visibility.

MATERIAL: Nylon
SPEC: For Ø31.8mm handlebar



ADP-KIOX-FBE-32 / 35

77-02

For new generation KIOX bracket.
Install KIOX display in front of the stem position.

MATERIAL: Nylon
SPEC: For Ø31.8mm / Ø35mm handlebar



ADP-KIOX-FBE-BAR-32 / 35

77-03

For new generation KIOX bracket include extension bar
for control unit.

MATERIAL: Nylon
SPEC: For Ø31.8mm / Ø35mm handlebar



ADP-KIOX-MBE-32 / 35

77-04

For new generation KIOX bracket.
Install KIOX display rear and left of the handlebar
position.

MATERIAL: Nylon
SPEC: For Ø31.8mm / Ø35mm handlebar



THRU AXLE

QUICK
RELEASE

SEAT CLAMP

TOP CAP

HEADSETS
PARTS

CRANK SET

CHAINRING
SYSTEMROLLER KIT
SERIES

BMX SERIES

CHAINRING
PARTSCHAIN GUIDE
SYSTEM

BRAKE SYSTEM

SEATPOST

STEM SYSTEM

HANDLEBAR

AEROBAR
SYSTEMCOMPUTER
MOUNT

CAGE

ACCESSORIES

FITTING
EQUIPMENT

PEDALS

**ADP-KIOX-GR-32 / 35**

78-01

Clamp type computer mount for KIOX on-board computer.**MATERIAL:** Nylon**SPEC:** For Ø31.8mm / Ø35mm handlebar**ADP-KIOX-GRBAR-32 / 35**

78-02

Clamp type computer mount for KIOX on-board computer.**MATERIAL:** Nylon**SPEC:** For Ø31.8mm / Ø35mm handlebar**ADP-KIOX-TOP**

78-03

Top cap type computer mount. For Kiox.**MATERIAL:** Nylon**SPEC:** For Ø28.6mm steerer tube**ADP-KIOX-GR-MB-32 / 35**

78-04

Clamp type computer mount for KIOX on-board computer.**MATERIAL:** Nylon**SPEC:** For Ø31.8mm / Ø35mm handlebar**ADP-KIOX-BWP**

78-05

Clamp type computer mount for Kiox on-board computer. For MTB bike.**MATERIAL:** Nylon**SPEC:** For Ø31.8mm handlebar clamp**ADP-KIOX-FP**

78-06

Clamp type computer mount for Kiox on-board computer. For Road bike / City bike.**MATERIAL:** Nylon**SPEC:** For Ø31.8mm handlebar clamp



THRU AXLE

QUICK RELEASE

SEAT CLAMP

TOP CAP

HEADSETS PARTS

CRANK SET

CHAINRING SYSTEM

ROLLER KIT SERIES

BMX SERIES

CHAINRING PARTS

CHAIN GUIDE SYSTEM

BRAKE SYSTEM

SEATPOST

STEM SYSTEM

HANDLEBAR

AEROBAR SYSTEM

COMPUTER MOUNT

CAGE

ACCESSORIES

FITTING EQUIPMENT

PEDALS



Extra space for quick-link.



Easy to access bottle sideward or upward.

WB-R1-20C WB-R1-20C-L

79-01

Unique geometric design of the bottle cage keeps the bottle securely in place during aggressive riding situations.

SPEC:

WB-R1-20 for right side to access water bottle.

WB-R1-20-L for left side to access water bottle.

MATERIAL: Carbon composite

WEIGHT: 32g/pcs



WB-R1-17C

79-02

Carbon long fiber with nylon injection.

MATERIAL: Carbon composite

WEIGHT: 30g/pcs



THRU AXLE

QUICK
RELEASE

SEAT CLAMP

TOP CAP

HEADSETS
PARTS

CRANK SET

CHAINRING
SYSTEMROLLER KIT
SERIES

BMX SERIES

CHAINRING
PARTSCHAIN GUIDE
SYSTEM

BRAKE SYSTEM

SEATPOST

STEM SYSTEM

HANDLEBAR

AEROBAR
SYSTEMCOMPUTER
MOUNT

CAGE

ACCESSORIES

FITTING
EQUIPMENT

PEDALS

**WB-STP52**

80-01

Excellent solution for extra parts storage.

MATERIAL: Bracket/ AL6061-T6
Strap/ Plastic+ Velcro

SPEC: Strap 25 x 250mm

**AR-STP34**

80-02

Extra storage spacer in stem area.

MATERIAL: Spacer/ AL6061-T6
Strap/ Plastic+ Velcro

SPEC: Spacer/ H 4mm, ID Ø28.6mm
Strap/ 25 x 250mm

**WB-EXT-M**

80-03

Bottle cage adapter.
Used to change the position of the
water bottle cage.
Adjustable range 46mm.

MATERIAL: AL6061-T6



PU-8705-TP02

81-01

For Road Bike (700C).

Besides tires and tubes, rim Tape is the third most important factor for puncture protection. The rim tape effectively protects the tube
SPEC: (W) 20 x (L) 2090mm

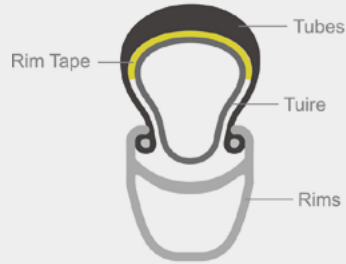
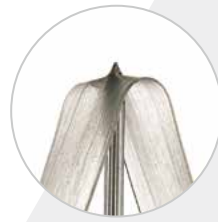

THRU AXLE

QUICK RELEASE

SEAT CLAMP

TOP CAP

HEADSETS PARTS

CRANK SET

CHAINRING SYSTEM

ROLLER KIT SERIES

BMX SERIES

CHAINRING PARTS

CHAIN GUIDE SYSTEM

BRAKE SYSTEM

SEATPOST

STEM SYSTEM

HANDLEBAR

AEROBAR SYSTEM

COMPUTER MOUNT

CAGE

ACCESSORIES

FITTING EQUIPMENT

PEDALS



PU-8705-TM01-26 PU-8705-TM01-29

81-02

For MTB.

Besides tires and tubes, rim Tape is the third most important factor for puncture protection. The rim tape effectively protects the tube against mechanical damage
SPEC: (W) 31 x (L) 2100mm (TM01-26)
 (W) 31 x (L) 2350mm (TM01-29)



PU-8703T2-100-1500

81-03

High modulus PU
 High puncture
 High string through resistance
SPEC: (W) 100 x (L) 1500mm



PU-8703-T2

81-04

High modulus PU
 High wear resistance
 High puncture resistance
SPEC: (W) 31 x (L) 230mm x 2pcs



PU-8703-T12

81-05

High modulus PU
 High wear resistance
 High puncture resistance
SPEC: 1. (W) 88 x (L) 92mm
 2. Ø30 x 30mm x 5pcs
 3. Ø50 x 20mm x 5pcs
 4. (W) 31 x (L) 230 mm x 1 pcs

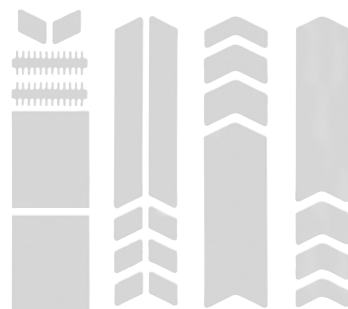

PU-8703-T22

81-06

The function of protector is to provide the best Friction resistance and protection for the frame, it keeps your frame new and clean.

MATERIAL: PVC
SPEC: Top tube protection x1
 Down tube protection x1
 Chainstay protection x2
 Frame or other protection x6
COLOR: 50% Transparent
WEIGHT: 31g

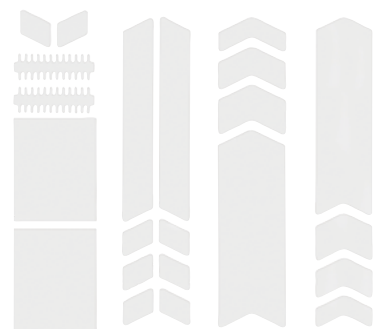

PU-9000-T22

81-07

The function of protector is to provide the best Friction resistance and protection for the frame, it keeps your frame new and clean.

MATERIAL: PU
SPEC: Top tube protection x1
 Down tube protection x1
 Chainstay protection x2
 Frame or other protection x6
H: 0.25mm
COLOR: Transparent
WEIGHT: 29g



THRU AXLE

QUICK
RELEASE

SEAT CLAMP

TOP CAP

HEADSETS
PARTS

CRANK SET

CHAINRING
SYSTEMROLLER KIT
SERIES

BMX SERIES

CHAINRING
PARTSCHAIN GUIDE
SYSTEM

BRAKE SYSTEM

SEATPOST

STEM SYSTEM

HANDLEBAR

AEROBAR
SYSTEMCOMPUTER
MOUNT

CAGE

ACCESSORIES

FITTING
EQUIPMENT

PEDALS



TL-BB-EXT56
TL-BB-EXT50
TL-BB-EXT48
TL-BB-EXT43

82-01

The **BOTTOM BRACKET TOOL** is made by high precision CNC machine to provide better contact area and stability of operation.

It can suitable for different specifications of BB and prevent tool slippage during use.

MATERIAL: AL7075

WEIGHT: **EXT56** 109g / **EXT50** 91g
EXT48 82g / **EXT43** 66g

COLOR: **EXT56** Silver / **EXT50** Gold
EXT48 Green / **EXT43** Gray

TL-BB-AXLE 2224
TL-BB-AXLE 2829
TL-BB-AXLE 2830

82-02

Suitable for different specifications of BB and prevent tool slippage during use.

MATERIAL: AL6061

WEIGHT: **AXLE2224** 59g / **AXLE2829** 117g
AXLE2830 125g

COLOR: **AXLE2224** Blue / **AXLE2829** Black
AXLE2830 Red



TL-BB-SET

82-03

Both sides of the tool are available to BB of different sizes, and the different colors make it easy to distinguish the sizes.

MATERIAL: AL7075 / AL6061

SPEC: Bottom bracket tool & Axle





M-FX-F / M-FX-R

83-01

For fixed gear axle.

MATERIAL: AL7075-T651
SPEC: M9 x 1.0, M10 x 1.0
LENGTH: 14mm, 18mm



RL-85V

83-02

Canti brake rear hanger



RL-85EC

83-03

Canti brake rear hanger



SHIM-R051 SHIM-R056

83-04

With flange.

SPEC: R051 (Ø31.8 x Ø25.4mm)
 R056 (Ø31.8 x Ø26mm)
H: 50mm or As Order



SHIM-11 / SHIM-21

83-05

Custom request available.

SPEC: SM11 (Ø31.8 x Ø25.4mm)
 SM21 (Ø28.6 x Ø25.4mm)
H: 50m



SHIM-21S

83-06

Custom request available.

SPEC: Ø28.6 x Ø25.4mm
H: 40m



TIP-4 / TIP-5

83-07

Rubber cover helps prevent dust and water.

MATERIAL: TPR
SPEC: 4mm, 5mm
COLOR: Black



1257A

83-08

Front cable hanger.

SPEC: With tube Ø25.4, Ø28.6
COLOR: Black & Silver

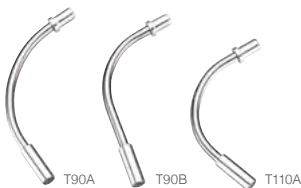

T90A / T90B / T110A

83-09

Stainless tube for V-brake.



1244A

83-10

MATERIAL: AL6061-T6

THRU AXLE

QUICK RELEASE

SEAT CLAMP

TOP CAP

HEADSETS PARTS

CRANK SET

CHAINRING SYSTEM

ROLLER KIT SERIES

BMX SERIES

CHAINRING PARTS

CHAIN GUIDE SYSTEM

BRAKE SYSTEM

SEATPOST

STEM SYSTEM

HANDLEBAR

AEROBAR SYSTEM

COMPUTER MOUNT

CAGE

ACCESSORIES

FITTING EQUIPMENT

PEDALS



THRU AXLE

QUICK RELEASE

SEAT CLAMP

TOP CAP

HEADSETS PARTS

CRANK SET

CHAINRING SYSTEM

ROLLER KIT SERIES

BMX SERIES

CHAINRING PARTS

CHAIN GUIDE SYSTEM

BRAKE SYSTEM

SEATPOST

STEM SYSTEM

HANDLEBAR

AEROBAR SYSTEM

COMPUTER MOUNT

CAGE

ACCESSORIES

FITTING EQUIPMENT

PEDALS



1270-L-F

1270-F-B

1270-F-A

1270-L-F / 1270-F-B / 1270-F-A

84-01

Cable hanger (bend tube) with adjustable screw. / Cold forged.

SPEC: Ø28.6mm Front
LONG-LEG: 34mm
COLOR: Black



MG-PR17

84-02

Durable, all-weather polypropylene material Smart-Fix construction for quick removal. For front fork.

MATERIAL: Polypropylene (PP)
THICKNESS: 1.2mm
COLOR: Black



MG-PF27

84-03

Durable, all-weather polypropylene material Smart-Fix construction for quick removal. For saddle rail.

MATERIAL: Polypropylene (PP)
THICKNESS: 1.2mm
COLOR: Black



MG-PR02

84-04

Durable, all-weather polypropylene material Smart-Fix construction for quick removal. For front fork.

MATERIAL: Polypropylene (PP)
THICKNESS: 0.8mm
COLOR: Black, Apple Green, Orange, Red, White, Yellow



NOT AVAILABLE IN EURO

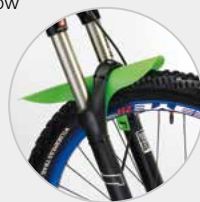

MG-PF12

84-05

Durable, all-weather polypropylene material Smart-Fix construction for quick removal. For saddle rail.

MATERIAL: Polypropylene (PP)
THICKNESS: 0.8mm
COLOR: Black, Apple Green, Orange, Red, White, Yellow



NOT AVAILABLE IN U.S.A

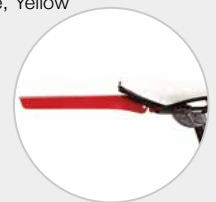



Property	Specification
Remanence	>1.3T
Polarization	Towards Sensor
Dimensions	Thickness > 0.5 x Diameter (h > 0.5 d) Diameter > Thickness (d > h)
Volume*	$V = \pi \times h \times (d / 2)^2$ Depending

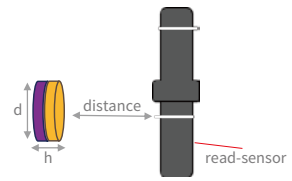
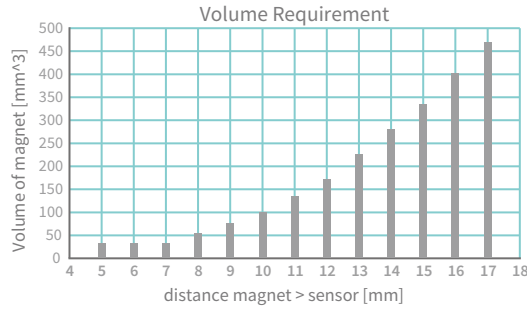

► 6-Bolt Magnet

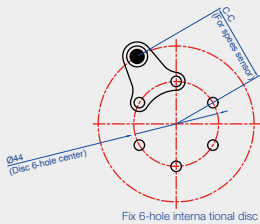

ADP-SHE8-1S



ADP-SHE8-2S



ADP-SHE8-3S



ADP-SHE8-W60S

► 5-Bolt Magnet

Fix SM-RTC60

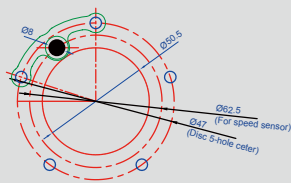

ADP-SHE8-P74S

► Center Lock Magnet

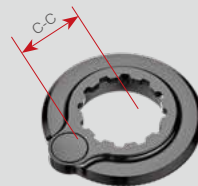

ADP-SHE8-MSH44-19

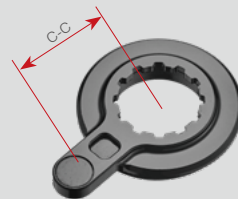

ADP-SHE8-MSH44-32

► Center Lock Magnet

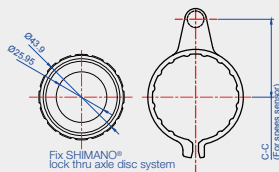

ADP-M-SHE8-32CS



ADP-M-SHE8-40CS



ADP-SHE8-P74S

85-01

For E-bike speed sensor adapter, can fix SHIMANO® SM-RTC60.

MATERIAL: Stainless washer with N45 SH magnet

SPEC: C-C 40mm



ADP-SHE8-1S
ADP-SHE8-2S / ADP-SHE8-3S
ADP-SHE8-W60S

85-02

For E-bike speed sensor adapter.

MATERIAL: Stainless washer with N45 SH magnet
SPEC:

ADP-SHE8-1S: C-C 32mm with 1mm magnet

ADP-SHE8-2S: C-C 32mm with 2mm magnet

ADP-SHE8-3S: C-C 40mm with 2mm magnet

ADP-SHE8-W60S: C-C 60mm with 2mm magnet

THRU AXLE

QUICK RELEASE

SEAT CLAMP

TOP CAP

HEADSETS PARTS

CRANK SET

CHAINING SYSTEM

ROLLER KIT SERIES

BMX SERIES

CHAINING PARTS

CHAIN GUIDE SYSTEM

BRAKE SYSTEM

SEATPOST

STEM SYSTEM

HANDLEBAR

AEROBAR SYSTEM

COMPUTER MOUNT

CAGE

ACCESSORIES

FITTING EQUIPMENT

PEDALS

- 
- THRU AXLE
- QUICK RELEASE
- SEAT CLAMP
- TOP CAP
- HEADSETS PARTS
- CRANK SET
- CHAINRING SYSTEM
- ROLLER KIT SERIES
- BMX SERIES
- CHAINRING PARTS
- CHAIN GUIDE SYSTEM
- BRAKE SYSTEM
- SEATPOST
- STEM SYSTEM
- HANDLEBAR
- AEROBAR SYSTEM
- COMPUTER MOUNT
- CAGE
- ACCESSORIES
- FITTING EQUIPMENT
- PEDALS



ADP-SHE8-WS 86-01

Washer of SHIMANO® disc rotor.
MATERIAL: Stainless steel
THICKNESS: 0.5mm



ADP-SHE8-HS 86-02

For E-bike speed sensor adapter.
MATERIAL: Stainless washer with N45 SH magnet
SPEC: C-C 32mm with 1mm magnet

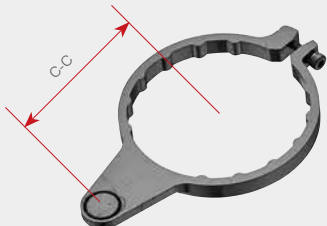

ADP-M-SHE8-32CS
ADP-M-SHE8-40CS 86-03

Locking adapter for E-bike speed sensor.
MATERIAL: AL6061 washer with N45 SH magnet
SPEC:
ADP-M-SHE8-1: C-C 32mm with 2mm magnet
ADP-M-SHE8-2: C-C 40mm with 2mm magnet



ADP-SH2 86-04

SHIMANO® center-lock disc hub adapter
 Stainless steel washer with alloy nut



ADP-SH1 86-05

SHIMANO® center-lock disc hub adapter
 Stainless steel washer with alloy nut



ADP-SH1220 86-06

SHIMANO® center-lock 12 / 20mm thru-axle disc hub adapter.
 With alloy locking (M-SH3611)
OPTION: Cr-Mo lock ring (M-SH1521-CR)

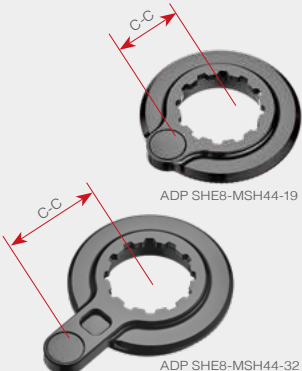

ADP SHE8-MSH44-19
ADP SHE8-MSH44-32 86-07

Center lock with integrated N45 SH magnet for E-BIKE speed sensor .
MATERIAL: AL6061-T6 /N45 SH magnet
 Center lock OD/44MM
SPEC:
ADP SHE8-MSH44-19: C-C 19mm with 3mm magnet
ADP SHE8-MSH44-32: C-C 32mm with 3mm magnet



ADP-DISC-SH-F 86-08

Center lock system.
 With alloy locking.
 Front 15mm boost hub adapter for 100mm transform to 110mm hub.



ADP-DISC-SH-R 86-09

Center lock system.
 With alloy locking.
 Rear 12mm boost hub adapter for 142mm transform to 148mm hub.



ADP-DISC-R6 86-10

Rear 12mm boost hub adapter for 142mm transform to 148mm hub.



ADP-DISC-F 86-11

Front 15mm boost hub adapter for 100mm transform to 110mm hub.



THRU AXLE

QUICK RELEASE

SEAT CLAMP

TOP CAP

HEADSETS PARTS

CRANK SET

CHAINRING SYSTEM

ROLLER KIT SERIES

BMX SERIES

CHAINRING PARTS

CHAIN GUIDE SYSTEM

BRAKE SYSTEM

SEATPOST

STEM SYSTEM

HANDLEBAR

AEROBAR SYSTEM

COMPUTER MOUNT

CAGE

ACCESSORIES

FITTING EQUIPMENT

PEDALS



CL-ISPEC-2 87-01

SHIMANO® SL-RS700 I-SPEC-2 flat bar shift lever to clamp type.

MATERIAL: AL6061-T6
SPEC: I-SPEC-2
COLOR: Sand blast black



EV-CLAMP-21 87-02

Shifter (shift lever) I-SPEC-EV mount.

MATERIAL: AL6061-T6
COMPATIBILITY HANDLEBAR: 22.2mm
COMPATIBILITY SHIFT LEVER: SHIMANO®



ADP-ISPEC2 87-03

SHIMANO® disc brake lever can fit SRAM® shift lever.

MATERIAL: AL6061-T6
WEIGHT: 16.2g/set

NEW
ADP-EV-POD-L 87-04

Adapter for SRAM® POD electronic controller mount on SHIMANO® I-SPEC-EV system disc brake lever.

MATERIAL: AL6061-T6
SPEC: I-SPEC-EV(L SIDE)
WEIGHT: 12g



NEW
ADP-EV-POD-R 87-05

Adapter for SRAM® POD electronic controller mount on SHIMANO® I-SPEC-EV system disc brake lever.

MATERIAL: AL6061-T6
SPEC: I-SPEC-EV(R SIDE)
WEIGHT: 12g



ADP-EVMX22 87-06

Adapter for SRAM® disc brake lever to SHIMANO® shift lever with screw and nut.

MATERIAL: Forged AL6061T6
SPEC: SRAM® MMX system to SHIMANO® I-SPEC-EV system
COLOR: Sand blast black

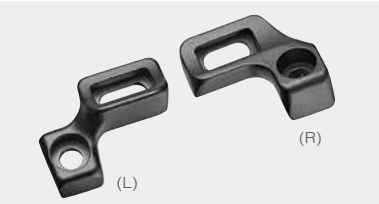

ADP-ISPEC-EV 87-07

SHIMANO® disc brake lever can fit SRAM® shift lever. With special screw and nut.

MATERIAL: AL6061 -T6
SPEC: I-SPEC-EV

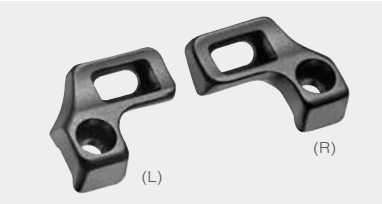

ADP-ISPEC-EV-21 87-08

SHIMANO® disc brake lever can fit SRAM® shift lever. With special screw and nut. **Left & right same angle.**

MATERIAL: AL6061 -T6
SPEC: I-SPEC-EV

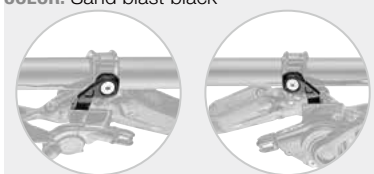

CL-STEMDR1 87-09

Down tube shifter mount to stem tube.

SPEC: Ø28.6, Ø22.2
Fit SHIMANO® 9 speed & 10 speed

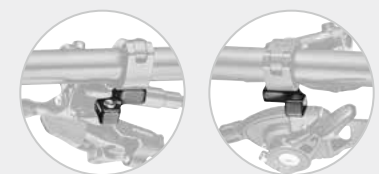

CL-HBDR1 87-10

Down tube shifter mount to handlebar.

SPEC: Clamp Ø26 with Ø24 & Ø22.2 Shim
Fit SHIMANO® 9 speed & 10 speed

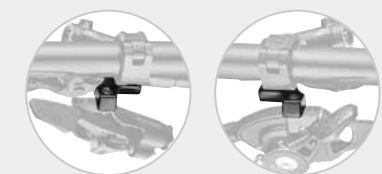

CL-DTDR1 87-11

Down tube shifter mount.

SPEC: Ø31.8 (With Ø28.6 Shim)
Fit SHIMANO® 9 speed & 10 speed



CL-ST22/CL-ST24 87-12

Clamp for ROAD bike lever.

MATERIAL: stainless
SPEC: CL-ST22: Ø22.2 × 12.5L, M5
CL-ST24: Ø24 × 14.9L, M6



CS-38 / CS-38B 87-13

Cable adjustable.

MATERIAL: AL6061-T6



THRU AXLE

QUICK RELEASE

SEAT CLAMP

TOP CAP

HEADSETS PARTS

CRANK SET

CHAINRING SYSTEM

ROLLER KIT SERIES

BMX SERIES

CHAINRING PARTS

CHAIN GUIDE SYSTEM

BRAKE SYSTEM

SEATPOST

STEM SYSTEM

HANDLEBAR

AEROBAR SYSTEM

COMPUTER MOUNT

CAGE

ACCESSORIES

FITTING EQUIPMENT

PEDALS



14T



12T

PUL-SR-EG1214 88-01

Fix SRAM® X01 Eagle pulley.

MATERIAL: AL7075 CNC made
TEETH: 12T upper / 14T bottom
BEARING OPTION:
 With 607R
 Cr-Mo steel seal bearing
 Ceramic ball seal bearing



PUL-SH-1313 88-02

MATERIAL: AL7075 CNC made
TEETH: 13T
BEARING OPTION:
 With 607R
 Cr-Mo steel seal bearing
 Ceramic ball seal bearing



PUL-J1-13 88-03

For SHIMANO® 1x12 speed, with Cr-Mo steel bearing.

MATERIAL: Nylon
TEETH: 13T



PUL-75W1 88-04

The wave shape design increases contact surface.
 Not for chain connectors.

MATERIAL: AL7075-T651 CNC made
TEETH: 11T
BEARING OPTION:
 Cr-Mo steel seal bearing
 Ceramic ball seal bearing
 Customized design CNC parts available



PUL-10 88-05

MATERIAL: AL6061 CNC made
BEARING OPTION:
 With 607R
 Cr-Mo steel seal bearing
 Ceramic ball seal bearing
TEETH: 10T



PUL-75C5 88-06

MATERIAL: AL7075-T651 CNC made
TEETH: 11T
BEARING OPTION:
 Cr-Mo steel seal bearing
 Ceramic ball seal bearing
 Customized design CNC parts available
OPTION: 12T / 13T /14T / 15T



PUL-02 88-07

MATERIAL: AL6061
BEARING OPTION:
 With 607R
 Cr-Mo steel seal bearing
 Ceramic ball seal bearing
TEETH: 10T



PUL-75C1 88-08

MATERIAL: AL7075-T651 CNC made
TEETH: 11T
BEARING OPTION:
 Cr-Mo steel seal bearing
 Ceramic ball seal bearing
 Customized design CNC parts available
OPTION: 12T / 13T /14T / 15T



PUL-110 88-09

MATERIAL: AL6061 CNC made
BEARING OPTION:
 With 607R
 Cr-Mo steel seal bearing
 Ceramic ball seal bearing
TEETH: 11T



PUL-P11 88-10

MATERIAL: Nylon
TEETH: 11T



THRU AXLE

QUICK RELEASE

SEAT CLAMP

TOP CAP

HEADSETS PARTS

CRANK SET

CHAINRING SYSTEM

ROLLER KIT SERIES

BMX SERIES

CHAINRING PARTS

CHAIN GUIDE SYSTEM

BRAKE SYSTEM

SEATPOST

STEM SYSTEM

HANDLEBAR

AEROBAR SYSTEM

COMPUTER MOUNT

CAGE

ACCESSORIES

FITTING EQUIPMENT

PEDALS



M5A10K

89-01

Special shape of the screw which can cover the bottle cage hole on the frame.

MATERIAL: AL7075
SPEC: M5 x 0.8
LENGTH: 10mm
WEIGHT: 1.4g/pcs



M517-F

89-02

For water bottle cage.

MATERIAL: AL7075 forged
SPEC: M5 x 0.8
LENGTH: 12mm or 16mm
COLOR: As Order
MAX: 6N.m
OPTION: Torx 25 available
WEIGHT: 1g/pcs (12mm)



M630-F

89-03

For top cap.

MATERIAL: AL7075-T73
SPEC: M6 x 1.0
LENGTH: 30mm
COLOR: As Order
WEIGHT: 2.8g/pcs



M512 / M515 M517

89-04

For water bottle cage.

MATERIAL: AL7075 CNC made
SPEC: M5 x 0.8
LENGTH: 12mm / 15mm / 17mm
MAX: 6N.m
WEIGHT: 1.3g/pcs



MCK-10

89-05

Chainring bolt.

MATERIAL: AL7075 CNC made
W: 5mm or 7mm
OPTION: 1. Torx 30 available
2. AR-12 x 10 (H: 2.5mm)
WEIGHT: 2g (5mm)



M103

89-06

Pivot nut for frame.

SPEC: M10 x 1.0
OPTION: M103E (M10 x 1.25)



M083

89-07

Pivot nut for front fork.

SPEC: M8 x 1.25



PLUG-IST-P01-MTB

89-08

Expander end cap for MTB.
For handlebar ID: Ø17 - Ø21mm.

MATERIAL:
Plastic body with stainless screw



PLUG-IST-P01-RC

89-09

Expander end cap for Road bike.
For handlebar ID: Ø17 - Ø21mm.

MATERIAL:
Plastic body with stainless screw



PLUG-PAN015

89-10

CNC bar end cap for Road bike.

MATERIAL: AL6061-T6 cap & silicone insert
WEIGHT: 37.5g/set
Not available in Japan



PLUG-24C

89-11

For Road bike.

MATERIAL: Plastic & Carbon fiber
SPEC: Ø22.2

ACCESSORIES



Post mount disc brake adapter SPEC list:

ITEM / SPEC	140-160mm	160-180mm	160-203mm	160-220mm	180-203mm	203-220mm
ADP-PM1622				•		
ADP-PM1820					•	
ADP-PM20-220						•
ADP-STD1618		•				
ADP-PM1618	•	•				
ADP-PM1620			•			



ADP-FA-P16 90-01

For flat mount fork adapter to post mount caliper.

MATERIAL: AL 6061-T6
SPEC: For 160m/m rotor
WEIGHT: 42g/pcs



ADP-FAPOST 90-02

Flat mount to post mount adapter.

MATERIAL: AL6061-T6
WEIGHT: 33g/pcs



ADP-FA1416 90-03

For mounting SHIMANO® flat mount calipers on flat mount fork.

MATERIAL: AL6061-T6
Fits 140mm / 160mm rotor



ADP-FA-R16 90-04

For mounting SHIMANO® flat mount calipers on flat mount frame.

MATERIAL: AL6061-T6
Fits 160mm rotor



ADP-RFA-P14 90-05

For flat mount frame adapter to post mount caliper.

MATERIAL: AL 6061-T6
SPEC: For 140m/m rotor
WEIGHT: 16g/pcs



ADP-RFA-P16 90-06

For flat mount frame adapter to post mount caliper.

MATERIAL: AL 6061-T6
SPEC: For 160m/m rotor
WEIGHT: 23g/pcs



ADP-RFA-P18 90-07

For flat mount frame adapter to post mount caliper.

MATERIAL: AL 6061-T6
SPEC: For 180m/m rotor
WEIGHT: 26g/pcs



ADP-PM1622 90-08

Post mount disc brake adapter. Adapter for 160mm to 220mm disc rotor.

MATERIAL: AL6061-T6
POST MOUNT: 74mm



ADP-PM1820 90-09

Post mount disc brake adapter. Adapter for 180mm to 203mm disc rotor.

MATERIAL: AL6061-T6
POST MOUNT: 74mm
WEIGHT: 14g/pcs



ADP-PM20-220 90-10

Post mount disc brake adapter. Adapter for 203mm to 220mm disc rotor.

MATERIAL: AL6061-T6
POST MOUNT: 74mm



ADP-STD1618 90-11

Post mount disc brake adapter. Adapter for 160mm to 180mm disc.

MATERIAL: AL6061-T6
WEIGHT: 18.5g/pcs



ADP-PM1618 90-12

Post mount disc brake adapter. Adapter for 140mm to 160mm / 160mm to 180mm disc.

MATERIAL: AL6061-T6
POST MOUNT: 74mm
WEIGHT: 10.5g/pcs

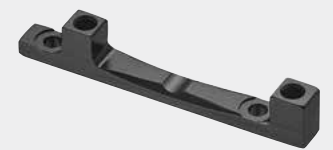

ADP-PM1620 90-13

Post mount to post mount for 203mm rotor only. Adapter for 160mm rotor to 203mm disc.

MATERIAL: AL6061-T6
POST MOUNT: 74mm
WEIGHT: 23g/pcs

THRU AXLE

QUICK RELEASE

SEAT CLAMP

TOP CAP

HEADSETS PARTS

CRANK SET

CHAINRING SYSTEM

ROLLER KIT SERIES

BMX SERIES

CHAINRING PARTS

CHAIN GUIDE SYSTEM

BRAKE SYSTEM

SEATPOST

STEM SYSTEM

HANDLEBAR

AEROBAR SYSTEM

COMPUTER MOUNT

CAGE

ACCESSORIES

FITTING EQUIPMENT

PEDALS



THRU AXLE

QUICK RELEASE

SEAT CLAMP

TOP CAP

HEADSETS PARTS

CRANK SET

CHAINRING SYSTEM

ROLLER KIT SERIES

BMX SERIES

CHAINRING PARTS

CHAIN GUIDE SYSTEM

BRAKE SYSTEM

SEATPOST

STEM SYSTEM

HANDLEBAR

AEROBAR SYSTEM

COMPUTER MOUNT

CAGE

ACCESSORIES

FITTING EQUIPMENT

PEDALS



PU-TLR 91-01

For tubeless ready rims tape.



MATERIAL: PET
SPEC: 19mm x 50M
 22mm x 50M
 33mm x 50M



NZ-TUSH-F 91-02

The multi-vent valve allows users to pump up tyres quickly and also works with most the foam-inserted tubeless tyres.

MATERIAL: AL6061-T6 with NBR taper cone spacer
SPEC: Presta valve
LENGTH: 47, 52, 62, 72, 87, 107mm







NZ-TUS-F 91-03

Tubeless valve.

MATERIAL: AL6061 with NBR tapped spacer
SPEC: Presta valve
LENGTH: 40, 45, 60, 70mm
 With NZ-CN5







NZ-GH 91-04

Tubeless valve (removable type) extender, can easily fixed by outer threaded nut.

MATERIAL: AL6061
SPEC: Tubeless Valve
LENGTH: 40, 60mm
OPTION: NZ-HF-TL





NZ-TL-TUS 91-05

Valve tool.

MATERIAL: Nylon, Alloy
COLOR: Black

NZ-CN5 91-06

Tubeless Valve cap.

MATERIAL: Nylon
SPEC: Presta Valve



NZ-AMTUS-F 91-07

Tubeless Valve for USA valve.

MATERIAL: AL6061 with NBR tappor spacer
SPEC: USA Valve
LENGTH: 40mm



NZ-NUT5 91-08

Special nut for tubeless presta valve, compatible with NZ-TL-TUS.

MATERIAL: AL6061
COLOR: BK
WITH: O-ring



Tubeless SET 91-09

Tubeless ready kit contains everything you need to complete your tubeless set-up.

SPEC: RIM TAPE (PU-TLR) x 1 roll
 WIDTH OPTION: 19mm x 50M / 22mm x 50M / 33mm x 50M
 TUBELESS VALVE (NZ-TUS-F) x 2 pcs
 LENGTH OPTION: 40mm / 45mm / 60mm / 70mm
 VALVE TOOL (NZ-TL-TUS) x 1 pcs
 VALVE CAP (NZ-CN5) x 2 pcs
OPTION: NZ-GH



THRU AXLE

QUICK RELEASE

SEAT CLAMP

TOP CAP

HEADSETS PARTS

CRANK SET

CHAINRING SYSTEM

ROLLER KIT SERIES

BMX SERIES

CHAINRING PARTS

CHAIN GUIDE SYSTEM

BRAKE SYSTEM

SEATPOST

STEM SYSTEM

HANDLEBAR

AEROBAR SYSTEM

COMPUTER MOUNT

CAGE

ACCESSORIES

FITTING EQUIPMENT

PEDALS

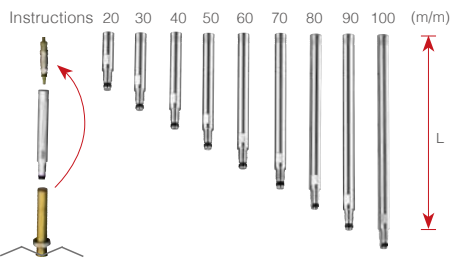

NZ-HF

92-01

MATERIAL: AL6061-T6
SPEC: Presta valve
LENGTH: 20 - 100mm
OPTION: NZ-HF-TL



NZ-F

92-02

MATERIAL: AL6061-T6
SPEC: Presta valve
LENGTH: 25, 38, 50 - 100mm



NZ-HF-TL

92-03

Valve tool.
MATERIAL: AL6061
COLOR: As Order



ADP-CO2-A1

92-04

Fits presta & USA valve without adapter. The simple threaded valve allows easy inflation.

MATERIAL: AL6061-T6 full CNC made



NZ-DISC

92-05

MATERIAL: AL6061-T6
SPEC: Disc wheel 90 degree adapter

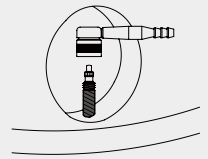

NZ-UF

92-06

MATERIAL: Copper or AL6061-T6
SPEC: Presta change to USA valve



NZ-KUF

92-07

With key ring.
MATERIAL: Copper or AL6061-T6
SPEC: Presta change to USA valve



NZ-01

93-01

MATERIAL: AL6061-T6
SPEC: USA valve

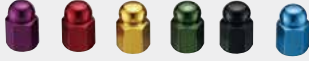

NZ-B5-WE

93-02

MATERIAL: AL6061-T6
SPEC: Presta valve



NZ-B1

93-03

MATERIAL: AL6061-T6
SPEC: USA valve



NZ-B2

93-04

MATERIAL: AL6061-T6
SPEC: USA valve



NZ-B3

93-05

MATERIAL: AL6061-T6
SPEC: USA valve

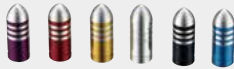

NZ-B4F

93-06

MATERIAL: AL6061-T6
SPEC: Presta valve

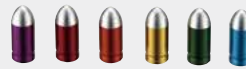

NZ-KULO

93-07

MATERIAL: Nylon plastic
SPEC: USA valve



NZ-KN

93-08

MATERIAL: Nylon plastic
SPEC: USA valve



NZ-18

93-09

MATERIAL: AL6061-T6
SPEC: USA valve



NZ-B6

93-10

MATERIAL: AL6061-T6
SPEC: USA valve



NZ-08

93-11

MATERIAL: AL6061-T6
SPEC: USA valve



NZ-FT

93-12

MATERIAL: AL6061-T6
SPEC: USA valve

THRU AXLE

QUICK RELEASE

SEAT CLAMP

TOP CAP

HEADSETS PARTS

CRANK SET

CHAINRING SYSTEM

ROLLER KIT SERIES

BMX SERIES

CHAINRING PARTS

CHAIN GUIDE SYSTEM

BRAKE SYSTEM

SEATPOST

STEM SYSTEM

HANDLEBAR

AEROBAR SYSTEM

COMPUTER MOUNT

CAGE

ACCESSORIES

FITTING EQUIPMENT

PEDALS



THRU AXLE

QUICK RELEASE

SEAT CLAMP

TOP CAP

HEADSETS PARTS

CRANK SET

CHAINRING SYSTEM

ROLLER KIT SERIES

BMX SERIES

CHAINRING PARTS

CHAIN GUIDE SYSTEM

BRAKE SYSTEM

SEATPOST

STEM SYSTEM

HANDLEBAR

AEROBAR SYSTEM

COMPUTER MOUNT

CAGE

ACCESSORIES

FITTING EQUIPMENT

PEDALS

RS

Option One Option two
Not available in Japan

Can be adjusted

For aero seatpost

NAME-AER017
NAME-AER017-RS 94-01

With bolt.
For easy drill card hold.
For aero seatpost.

WEIGHT: 14g/set

NAME-P
NAME-P-RS 94-02

With bolt.
For easy drill card hold.

WEIGHT: 15g/set

NAME-AERO
NAME-AERO-RS 94-03

Special design available.

WEIGHT: 12.5g/set

WG-24F 94-04

Cold forged.

MATERIAL: AL6061-T6
SPEC: Ø34.9mm
COLOR: As Order
Custom design available

RS-MINI BAR 94-05

Create an additional hand position on the handlebar. Minimizes hand numbness, carpal and ulnar issues.

MATERIAL: Nylon
SPEC: ID Ø22.2mm
WEIGHT: 17.8g/set

RS-MINI BAR-02 94-06

New design can combination with lock-on grip.

MATERIAL: Nylon
WEIGHT: 30.4g/set

► TL-101-1 Features: Combo pliers content

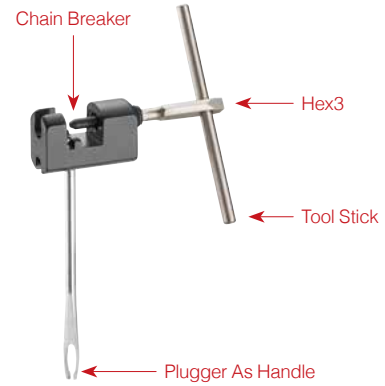
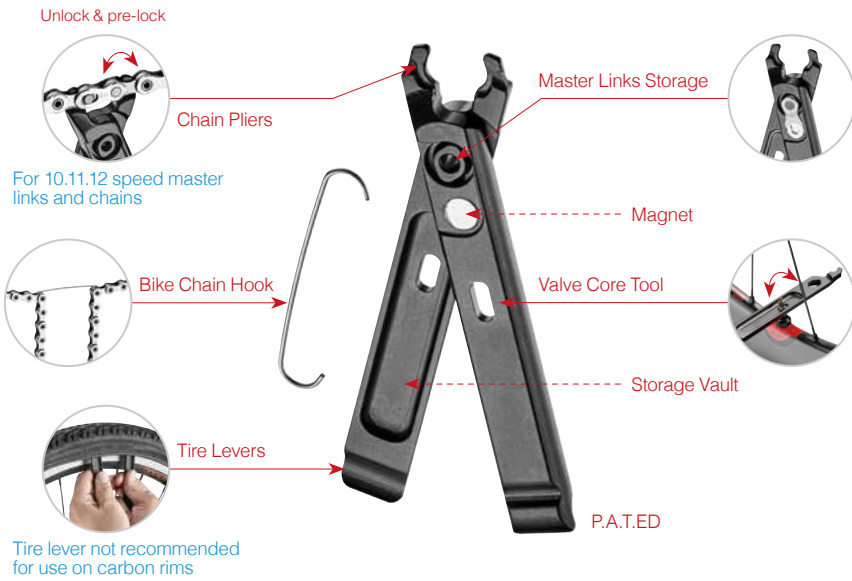

► TL-102-1 Features: Tubeless repair kit



Chain breaker

P.A.T.E.D

Front

Back

TL-500

95-01

End cap style storage for MTB alloy handle bar.

COMBO PLIER FEATURES:
Master link tool / Master link storage / Valve core tool / Tire lever / Bike chain hook / Storage vault
Patent in multiple countries
MATERIAL: Forged alloy and CNC machined
WEIGHT: 38.5g
TUBELESS REPAIR KIT CONTENT:
Reamer / Pluggers / Tire seal strip
6 PCS BITS CONTENT:
Hex3 / 4 / 5 / 6 / PH1 / T25 with tool stick

- THRU AXLE
- QUICK RELEASE
- SEAT CLAMP
- TOP CAP
- HEADSETS PARTS
- CRANK SET
- CHAINRING SYSTEM
- ROLLER KIT SERIES
- BMX SERIES
- CHAINRING PARTS
- CHAIN GUIDE SYSTEM
- BRAKE SYSTEM
- SEATPOST
- STEM SYSTEM
- HANDLEBAR
- AEROBAR SYSTEM
- COMPUTER MOUNT
- CAGE
- ACCESSORIES
- FITTING EQUIPMENT
- PEDALS



THRU AXLE

QUICK RELEASE

SEAT CLAMP

TOP CAP

HEADSETS PARTS

CRANK SET

CHAINRING SYSTEM

ROLLER KIT SERIES

BMX SERIES

CHAINRING PARTS

CHAIN GUIDE SYSTEM

BRAKE SYSTEM

SEATPOST

STEM SYSTEM

HANDLEBAR

AEROBAR SYSTEM

COMPUTER MOUNT

CAGE

ACCESSORIES

FITTING EQUIPMENT

PEDALS



Compatible with the CO2 Cartridge or the ADP-CO2-A1-T / ADP-CO2-A1-C (optional).



Option ADP-CO2-A1-T



Threaded CO2 cartridges

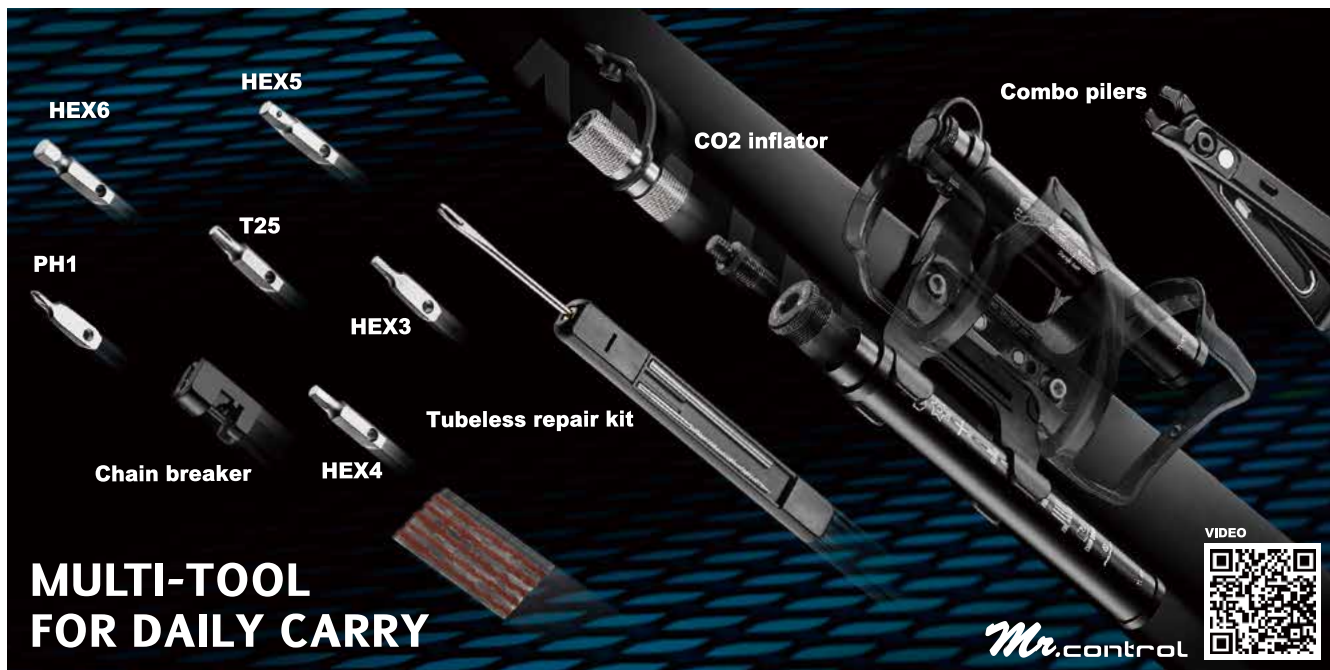

MULTI-TOOL FOR DAILY CARRY

Mr. CONTROL



P.A.T.ED

Front Back

TL-600

96-01

Multi tool storage tube with CO2 cartridges thread.

COMBO PLIER FEATURES:

Master link tool / Master link storage / Valve core tool / Tire lever / Bike chain hook / Storage vault Patent in multiple countries

MATERIAL: Forged alloy and CNC machined
WEIGHT: 38.5g

TUBELESS REPAIR KIT CONTENT:

Reamer / Plugger / Tire seal strip

6 PCS BITS CONTENT:

Hex3 / 4 / 5 / 6 / PH1 / T25 with tool stick



P.A.T.ED

Front Back

TL-700

96-02

Multi tool storage tube with CO2 cartridges thread. compatible ADP-CO2-A1-T.

Include tube holder WB-UHD-22 for two pieces.

COMBO PLIER FEATURES:

Master link tool / Master link storage / Valve core tool / Tire lever / Bike chain hook / Storage vault Patent in multiple countries

MATERIAL: Forged alloy and CNC machined
WEIGHT: 38.5g

TUBELESS REPAIR KIT CONTENT:

Reamer / Plugger / Tire seal strip

6 PCS BITS CONTENT:

Hex3 / 4 / 5 / 6 / PH1 / T25 with tool stick





THRU AXLE

QUICK RELEASE

SEAT CLAMP

TOP CAP

HEADSETS PARTS

CRANK SET

CHAINRING SYSTEM

ROLLER KIT SERIES

BMX SERIES

CHAINRING PARTS

CHAIN GUIDE SYSTEM

BRAKE SYSTEM

SEATPOST

STEM SYSTEM

HANDLEBAR

AEROBAR SYSTEM

COMPUTER MOUNT

CAGE

ACCESSORIES

FITTING EQUIPMENT

PEDALS



TL-750

97-01

Multi tool storage tube with CO2 cartridges thread. compatible ADP-CO2-A1-T. Include tube holder WB-UHD-22 for two pieces and end cap style storage TL-501 for MTB alloy handle bar.

COMBO PLIER FEATURES:

Master link tool / Master link storage / Valve core tool / Tire lever / Bike chain hook / Storage vault Patent in multiple countries

MATERIAL: Forged alloy and CNC machined

WEIGHT: 38.5g

TUBELESS REPAIR KIT CONTENT:

Reamer / Plugger / Tire seal strip

6 PCS BITS CONTENT:

Hex3 / 4 / 5 / 6 / PH1 / T25 with tool stick



TL-801

97-02

Multi tool storage long tube with CO2 cartridges thread. compatible ADP-CO2-A1-T. Include tube holder WB-UHD-22 for two pieces. Bicycle pump compatible Presta and Schrader valve.

COMBO PLIER FEATURES:

Master link tool / Master link storage / Valve core tool / Tire lever / Bike chain hook / Storage vault Patent in multiple countries

MATERIAL: Forged alloy and CNC machined

WEIGHT: 38.5g

TUBELESS REPAIR KIT CONTENT:

Reamer / Plugger / Tire seal strip

6 PCS BITS CONTENT:

Hex3 / 4 / 5 / 6 / PH1 / T25 with tool stick



TL-800

97-03

Multi tool storage long tube with CO2 cartridges thread. compatible ADP-CO2-A1-T. Include tube holder WB-UHD-22 for two pieces. Bicycle pump compatible Presta and Schrader valve.

COMBO PLIER FEATURES:

Master link tool / Master link storage / Valve core tool / Tire lever / Bike chain hook / Storage vault Patent in multiple countries

MATERIAL: Forged alloy and CNC machined

WEIGHT: 38.5g

TUBELESS REPAIR KIT CONTENT:

Reamer / Plugger / Tire seal strip

6 Pcs bits content:

Hex3 / 4 / 5 / 6 / PH1 / T25 with tool stick

ADP-CO2-A1-T:

Connect with storage tube through adapter

Fits Presta & USA valve

The simple threaded valve allows easy inflation



ACCESSORIES

- 
- THRU AXLE
- QUICK RELEASE
- SEAT CLAMP
- TOP CAP
- HEADSETS PARTS
- CRANK SET
- CHAINRING SYSTEM
- ROLLER KIT SERIES
- BMX SERIES
- CHAINRING PARTS
- CHAIN GUIDE SYSTEM
- BRAKE SYSTEM
- SEATPOST
- STEM SYSTEM
- HANDLEBAR
- AEROBAR SYSTEM
- COMPUTER MOUNT
- CAGE
- ACCESSORIES
- FITTING EQUIPMENT
- PEDALS

NEW

ADP-GR-LHSOS

98-01

Light holder with integrated tubeless repair kit.

MATERIAL: AL6061-T6
TUBELESS REPAIR KIT CONTENT
 Reamer/Plugger/Tire seal strip
COLOR: AS ORDER
WEIGHT: 45g



NEW

ADP-GR-LHTL

98-02

Light holder with integrated tool bits.

MATERIAL: AL6061-T6
3PCS BITS CONTENT
 HEX 5MM/4MM/T25
COLOR: AS ORDER
WEIGHT: 60g



NEW

ADP-GR-LH

98-03

Light holder for gravel bike to mount on the fork or thru axle with M5 thread.

MATERIAL: AL6061-T6
COLOR: AS ORDER
WEIGHT: 24g

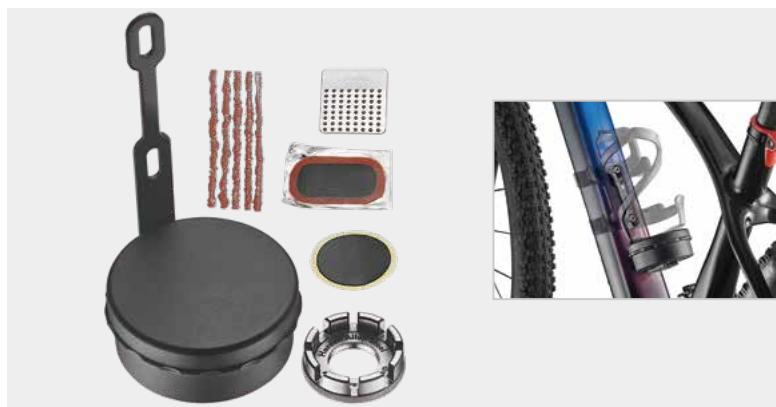

TL-105

98-04

Stainless steel plate nylon container.

CONTENT:
 Spoke wrench x 1pcs / Patch x 12pcs
 Tire seal strip x 5pcs / Self-adhesive patch x12pcs
 Grinder x 1pcs



TL-105-E

98-05

CONTENT:
 Stainless steel Bracket x 1pc / Nylon container x 1pc



F-STRAP-BAG

98-06

Quick and easy to carry repair kits when long distance riding, include mounting bag to helpful for sorting kit.

VELCRO LENGTH: 58cm



Spare part are not included.



F-STRAP

98-07

Quick and easy to carry repair kits when long distance riding.

VELCRO LENGTH: 58cm



Spare part are not included.



SDM-HANGER-001

99-01

FIT 2023 GIANT® TCR & PROPEL & DEFY.

MATERIAL: AL6061-T6
Customized available



NEW

UDH-HANGER-SH

99-02

Universal Derailleur Hanger for SHIMANO® system.

MATERIAL: AL6061-T6 BODY / 6066-T6 BOLT
COLOR: Black
WEIGHT: 34.5g/set



UDH-HANGER

BEST SELLER

99-03

The Universal Derailleur Hanger.

MATERIAL: AL6066-T6 BODY / NYLON FRAME
WEIGHT: 27g/pcs



NEW

UDH-HANGER-AL

99-04

Hanger never get damaged.

MATERIAL:
Hanger and Washer: AL6061-T6
Bolt : AL6066-T6



NEW

UDH-HANGER-P2

99-05

Featuring an aluminum alloy axle with the original nylon plastic styling outline preserved.

MATERIAL:
Body / Bolt: AL6066-T6
Frame shape: Nylon



R2 / R2-X

99-06

Rear derailleur protector.

R2: Compatible quickrelease dropout.
R2-X: Compatible SHIMANO® shadow derailleur.



R2

R2-X



RG-AK1

99-07

Stem spacer ring bell OD Ø28.6mm



RG-ARK

99-08

Stem spacer ring bell OD Ø28.6mm

THRU AXLE

QUICK RELEASE

SEAT CLAMP

TOP CAP

HEADSETS PARTS

CRANK SET

CHAINRING SYSTEM

ROLLER KIT SERIES

BMX SERIES

CHAINRING PARTS

CHAIN GUIDE SYSTEM

BRAKE SYSTEM

SEATPOST

STEM SYSTEM

HANDLEBAR

AEROBAR SYSTEM

COMPUTER MOUNT

CAGE

ACCESSORIES

FITTING EQUIPMENT

PEDALS



THRU AXLE

QUICK
RELEASE

SEAT CLAMP

TOP CAP

HEADSETS
PARTS

CRANK SET

CHAINRING
SYSTEMROLLER KIT
SERIES

BMX SERIES

CHAINRING
PARTSCHAIN GUIDE
SYSTEM

BRAKE SYSTEM

SEATPOST

STEM SYSTEM

HANDLEBAR

AEROBAR
SYSTEMCOMPUTER
MOUNT

CAGE

ACCESSORIES

FITTING
EQUIPMENT

PEDALS



1. Choose a suitable fixing hole for the strap when the quick-release handle is in the open position.



2. Secure the straps completely into the mounting bracket.



3. Assembly is complete by closing the quick-release handle.

NEW
CL-CRZ

100-01

Seatpost-mounted connector designed for single-stay rear racks, featuring quick installation and secure attachment.

Compatible with various shapes and different sizes seatposts.

MATERIAL: Nylon lever and bracket.
Rubber strape.

Patent pending.



THRU AXLE

QUICK RELEASE

SEAT CLAMP

TOP CAP

HEADSETS PARTS

CRANK SET

CHAINING SYSTEM

ROLLER KIT SERIES

BMX SERIES

CHAINING PARTS

CHAIN GUIDE SYSTEM

BRAKE SYSTEM

SEATPOST

STEM SYSTEM

HANDLEBAR

AEROBAR SYSTEM

COMPUTER MOUNT

CAGE

ACCESSORIES

FITTING EQUIPMENT

PEDALS



ADP-BT-S

101-01

Holder for SRAM® AXS/ ETAP battery.

MATERIAL: Nylon66
COLOR: Black
With cable tie
Battery not included



TK-ATG01

101-02

Top cap with Air Tag holder, special locking tool include.

MATERIAL: Top cap: AL6061
Tool: Nylon
WEIGHT: 28g/set
Air Tag not included



WB-ATG-02

101-03

Air Tag holder that mount on the bike frame water bottle attachment point, and zip tip under the bike saddle rail.

MATERIAL: Nylon66
COLOR: Black
WEIGHT: 23g/pcs (With bolt)
Air Tag not included



TL-3X-65 / TL-3X-80 TL-3X-B65 / TL-3X-B80

BEST SELLER

101-04

MATERIAL: Heat treated steel (ASM 6150)
Nylon body
LENGTH: 65mm, 80mm
ALLENKEY TYPE: 4mm, 5mm, 6mm
Customer with logo available

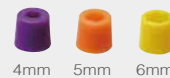

M-BOT-A / M-BOT-C

101-05

Lamp peg & R.D protector.

MATERIAL:
M-BOT-A: AL6061-T6
M-BOT-C: Carbon



M-BOT-A
(Only for front wheel)



M-BOT-C
(For front and rear wheel)



M-BOT-A



M-BOT-C

ANTI NUT CO-L(AM)

101-06

MATERIAL: STEEL NUT / AL6061T6 CONE
SPEC: M9*1.0, M10*1.0, 3/8*26T
LENGTH: 30mm
With special allen key



ANTI NUT CO-E(OE)

101-07

MATERIAL: STEEL
SPEC: M9*1.0, M10*1.0, 3/8*26T
LENGTH: 23mm / 28mm
With special allen key





THRU AXLE

QUICK RELEASE

SEAT CLAMP

TOP CAP

HEADSETS PARTS

CRANK SET

CHAINRING SYSTEM

ROLLER KIT SERIES

BMX SERIES

CHAINRING PARTS

CHAIN GUIDE SYSTEM

BRAKE SYSTEM

SEATPOST

STEM SYSTEM

HANDLEBAR

AEROBAR SYSTEM

COMPUTER MOUNT

CAGE

ACCESSORIES

FITTING EQUIPMENT

PEDALS



ADP-FIT-WR

102-01

Quick and easy to change position for trainer or fitting. Angle adjustment from 0 to 12 degrees. Three wheels allow it to adjust itself.

HEIGHT RANGE: 80- 290 mm

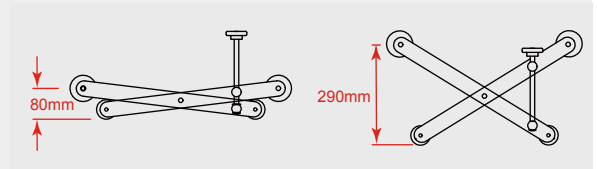



ADP-FIT-RHB

103-01

Allow you to find the most appropriate handlebar width swiftly and painlessly. Ease your physical fatigue for long distance riding.

MATERIAL: AL6061
SPEC: 320~440mm
DROP: 125mm
REACH: 70mm

Only for fitting setting not for outdoor riding.



Find your perfect handlebar width swiftly.



ADP-FIT-E220

103-02

Adjustable welding stem.

MATERIAL: AL6066
ANGLE: ±8°
CLAMP HEIGHT: 50mm
C-C: 205mm
STEM TUBE SIZE: Ø28.6mm



Only for fitting setting not for outdoor riding.

ADP-FIT-SA

103-03

FORK STACK HIGH: Ø40mm, Ø31.8mm with shim Ø28.6mm
HANDLEBAR CLAMP: Ø31.8mm
LENGTH: 50 - 150mm
ANGLE: ±25°
OPTION: Ø35mm Clamp



ADP-FIT-XYA

103-04

Stem slimmension inspection platform.

MATERIAL: AL6061-T6
SPEC:

HANDLEBAR STEM: Ø31.8 x Ø34.9 x (H)50mm x 1pcs
SPACER: IDØ28.6 x ODØ34.2 x (H)3mm x 2pcs
 IDØ28.6 x ODØ34.2 x (H)5mm x 2pcs
 IDØ28.6 x ODØ34.2 x (H)10mm x 1pcs
 IDØ31.8 x ODØ38.8 x (H)2.5mm x 2pcs
 IDØ31.8 x ODØ38.8 x (H)5mm x 2pcs
 IDØ31.8 x ODØ38.8 x (H)10mm x 1pcs
SHIM-CC-AL: IDØ28.6 x ODØ31.8 x (H)38mm x 1pcs
 IDØ31.8 x ODØ34.9 x (H)58mm x 1pcs
WEIGHT: 2.515kg/set

ADP-FIT-CZ

103-05

Precision CNC machines fitting bike sizing cranks.

CRANK LENGTH: 145, 150, 155, 160, 165, 167.5, 170, 172.5, 175, 177.5, 180mm

AXLE: 24mm / 30mm
MATERIAL: Crank: AL6061-T6
 Axle: AL7075-T651
CHAINRING: Single 46T



Specifications are subject to change without notice.

THRU AXLE

QUICK RELEASE

SEAT CLAMP

TOP CAP

HEADSETS PARTS

CRANK SET

CHAINRING SYSTEM

ROLLER KIT SERIES

BMX SERIES

CHAINRING PARTS

CHAIN GUIDE SYSTEM

BRAKE SYSTEM

SEATPOST

STEM SYSTEM

HANDLEBAR

AEROBAR SYSTEM

COMPUTER MOUNT

CAGE

ACCESSORIES

FITTING EQUIPMENT

PEDALS



THRU AXLE

QUICK
RELEASE

SEAT CLAMP

TOP CAP

HEADSETS
PARTS

CRANK SET

CHAINRING
SYSTEM

ROLLER KIT
SERIES

BMX SERIES

CHAINRING
PARTS

CHAIN GUIDE
SYSTEM

BRAKE SYSTEM

SEATPOST

STEM SYSTEM

HANDLEBAR

AEROBAR
SYSTEM

COMPUTER
MOUNT

CAGE

ACCESSORIES

FITTING
EQUIPMENT

PEDALS

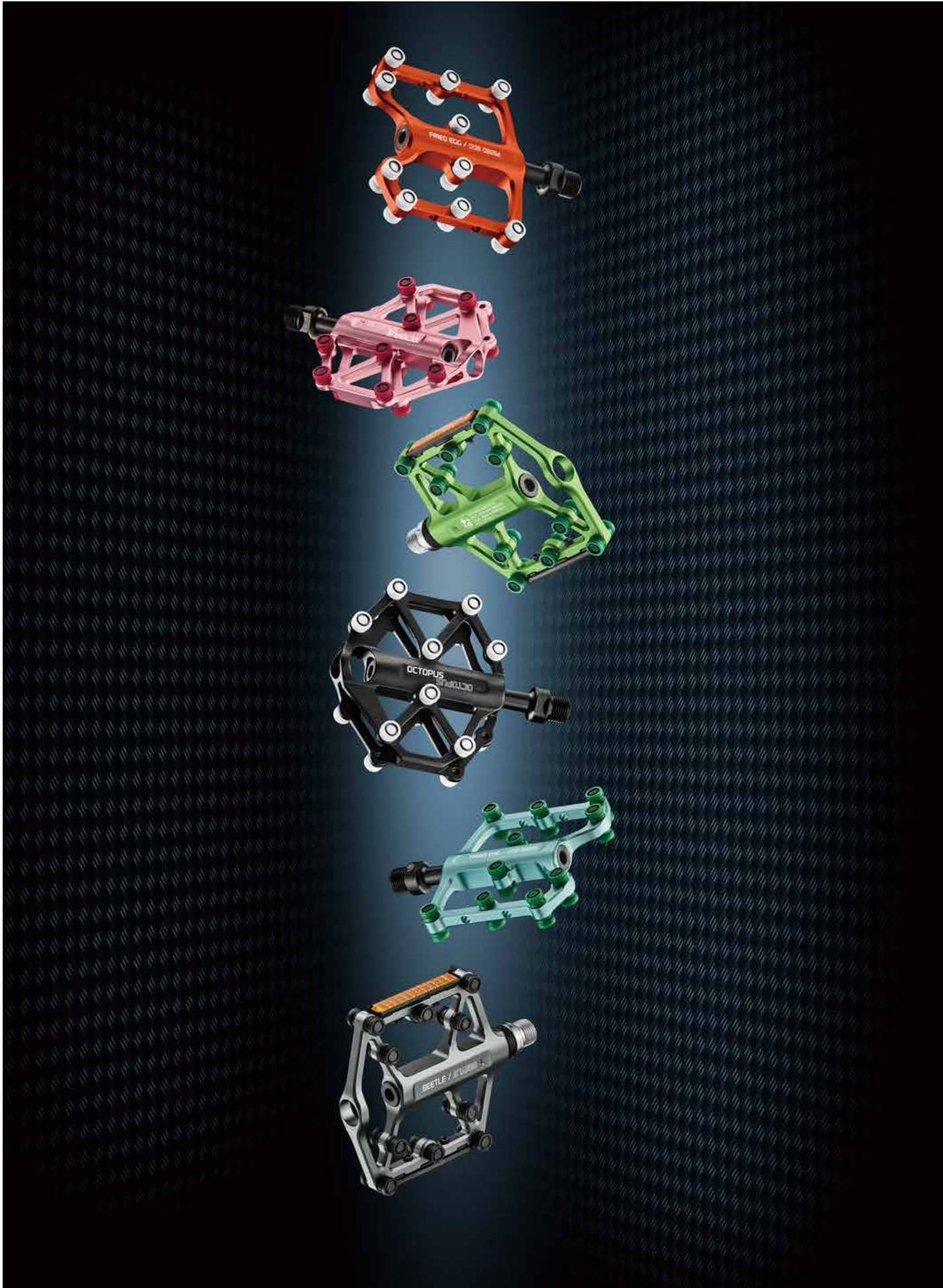

Safety & Anti-slip & Comfort.
Innovation concept combine function and safety, let your ride with confidence.

R-PIN:



Traditional Pins.



R-PIN

PATENTED,M658172,CN, ZL 2024 2 0439842.6, CN, ZL 2024 2 0148501.3,P.C.T...

Made by heat treatment carbon steel and multi-tool to replace your damaged pins.

T-PIN:

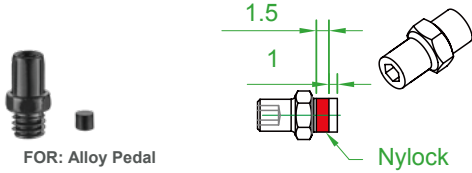

FOR: Alloy Pedal



2 functions:
Hex socket 2mm
External hex 5mm



Six different colors Aluminium body :

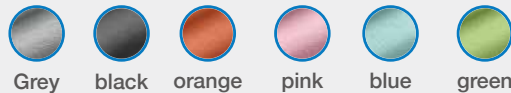

NEW

**PD-FOUR-CLOVER (R-PIN)
PD-FOUR-CLOVER-2 (T-PIN)**

105-01



S

Safety & Anti-slip & Comfort
Innovation concept combine function and safety, let your ride with confidence.

MATERIAL:
Body: AL6061T6 CNC made
Axle: Cr-Mo Cold-Forged
PLATFORM SIZE: 75 x 90 x 83 (L2xWxL1)
PIN: 24 per side
WEIGHT:
PD-FOUR-CLOVER PEDAL 377g/pair REFLECTORS 8.8g/set
PD-FOUR-CLOVER-2 PEDAL 355g/pair REFLECTORS 8.8g/set

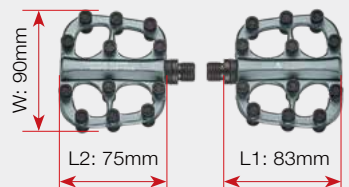

NEW

**PD-MODEL-Y80 (R-PIN)
PD-MODEL-Y80-2 (T-PIN)**

105-02



M

Safety & Anti-slip & Comfort
Innovation concept combine function and safety, let your ride with confidence.

MATERIAL:
Body: AL6061T6 CNC made
Axle: Cr-Mo Cold-Forged
PLATFORM SIZE: 100 x 80 x 108 (L2xWxL1)
PIN: 20 per side
WEIGHT:
PD-MODEL Y80 PEDAL 350g/pair REFLECTORS 8.8g/set
PD-MODEL Y80-2 PEDAL 332g/pair REFLECTORS 8.8g/set

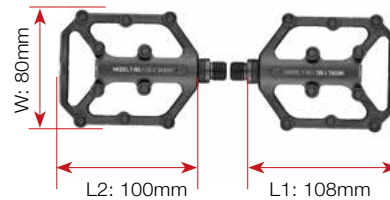

NEW

**PD-ROCKET (R-PIN)
PD-ROCKET-2 (T-PIN)**

105-03



L

Safety & Anti-slip & Comfort
Innovation concept combine function and safety, let your ride with confidence.

MATERIAL:
Body: AL6061T6 CNC made
Axle: Cr-Mo Cold-Forged
PLATFORM SIZE: 82 x 100 x 106.5 (L2xWxL1)
PIN: 16 per side
WEIGHT: PD-ROCKET PEDAL 278g/pair REFLECTORS 8.8g/set
PD-ROCKET-2 PEDAL 266g/pair REPAEZTORS 8.8g/set

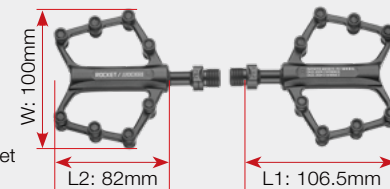

THRU AXLE

QUICK RELEASE

SEAT CLAMP

TOP CAP

HEADSETS PARTS

CRANK SET

CHAINRING SYSTEM

ROLLER KIT SERIES

BMX SERIES

CHAINRING PARTS

CHAIN GUIDE SYSTEM

BRAKE SYSTEM

SEATPOST

STEM SYSTEM

HANDLEBAR

AEROBAR SYSTEM

COMPUTER MOUNT

CAGE

ACCESSORIES

FITTING EQUIPMENT

PEDALS

- THRU AXLE
- QUICK RELEASE
- SEAT CLAMP
- TOP CAP
- HEADSETS PARTS
- CRANK SET
- CHAINRING SYSTEM
- ROLLER KIT SERIES
- BMX SERIES
- CHAINRING PARTS
- CHAIN GUIDE SYSTEM
- BRAKE SYSTEM
- SEATPOST
- STEM SYSTEM
- HANDLEBAR
- AEROBAR SYSTEM
- COMPUTER MOUNT
- CAGE
- ACCESSORIES
- FITTING EQUIPMENT
- PEDALS**



L

NEW

PD-BEETLE (R-PIN)
PD-BEETLE-2 (T-PIN)

106-01

Safety & Anti-slip & Comfort
Innovation concept combine function and safety, let you ride with confidence.

MATERIAL:
Body: AL6061T6 CNC made
Axle: Cr-Mo Cold-Forged
PLATFORM SIZE: 100 x 100 x 110 (L2xWxL1)
PIN: 20 per side
WEIGHT:
PD-BEETLE
PEDAL: 370g/pair
REFLECTORS 8.8g/set
PD-BEETLE-2
PEDAL: 338g/pair
REFLECTORS 8.8g/set





W: 100mm
L2: 100mm

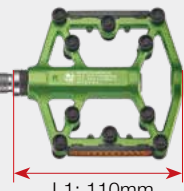

L1: 110mm



L

NEW

PD-FRIED-EGG (R-PIN)
PD-FRIED-EGG-2 (T-PIN)

106-02

Safety & Anti-slip & Comfort
Innovation concept combine function and safety, let you ride with confidence.

MATERIAL:
Body: AL6061T6 CNC made
Axle: Cr-Mo Cold-Forged
PLATFORM SIZE: 86 x 100 x 109 (L2xWxL1)
PIN: 20 per side
WEIGHT:
PD-FRIED EGG
PEDAL: 340g/pair
REFLECTORS 8.8g/set
PD-FRIED EGG-2
PEDAL: 322g/pair
REFLECTORS 8.8g/set





W: 100mm
L2: 86mm



L1: 109mm



L

NEW

PD-OCTOPUS (R-PIN)
PD-OCTOPUS-2 (T-PIN)

106-03

Safety & Anti-slip & Comfort
Innovation concept combine function and safety, let you ride with confidence.

MATERIAL:
Body: AL6061T6 CNC made
Axle: Cr-Mo Cold-Forged
PLATFORM SIZE: 89 x 98 x 114 (L2xWxL1)
PIN: 16 per side
WEIGHT:
PD-OCTOPUS
PEDAL: 330g/pair
REFLECTORS 8.8g/set
PD-OCTOPUS-2
PEDAL: 318g/pair
REFLECTORS 8.8g/set



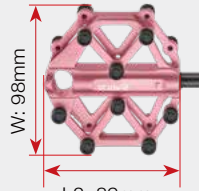

W: 98mm
L2: 89mm

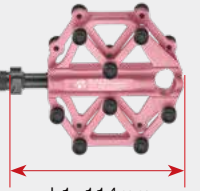

L1: 114mm



L

NEW

PDP-110-01

106-04

High-strength nylon pedals with multiple optional pin combinations meet the needs of different riders. The wide platform design enhances pedaling comfort, providing greater stability while riding.

MATERIAL:
Body: Nylon Composite
Axle: Cr-Mo Cold-Forged
PLATFORM SIZE: 108 x 116 x 116 (L2xWxL1)





W: 116mm
L2: 108mm



L1: 116mm





2XL

NEW

PD-RIB-125 (R-PIN)
PD-RIB-125-2 (T-PIN)

106-05

Safety & Anti-slip & Comfort
Innovation concept combine function and safety, let your ride with confidence.

MATERIAL:
Body: AL6061T6 CNC made
Axle: Cr-Mo Cold-Forged
PLATFORM SIZE: 100 x 125 x 108 (L2xWxL1)
PIN: 24 per side
WEIGHT:
PD-RIB PEDAL: 437g/pair REFLECTORS 8.8g/set
PD-RIB-2 PEDAL: 417g/pair REFLECTORS 8.8g/set





W: 125mm
L2: 100mm



L1: 108mm



THRU AXLE

QUICK RELEASE

SEAT CLAMP

TOP CAP

HEADSETS PARTS

CRANK SET

CHAINING SYSTEM

ROLLER KIT SERIES

BMX SERIES

CHAINING PARTS

CHAIN GUIDE SYSTEM

BRAKE SYSTEM

SEATPOST

STEM SYSTEM

HANDLEBAR

AEROBAR SYSTEM

COMPUTER MOUNT

CAGE

ACCESSORIES

FITTING EQUIPMENT

PEDALS



NEW

PD-PEACE-125 (R-PIN) PD-PEACE-125-2 (T-PIN)

107-01

Safety & Anti-slip & Comfort
Innovation concept combine function and safety, let you ride with confidence.

MATERIAL:
Body: AL6061T6 CNC made
Axle: Cr-Mo Cold-Forged
PLATFORM SIZE: 100 x 124 x 108 (L2xWxL1)
PIN: 24 per side
WEIGHT:
PD-PEACE PEDAL: 410g/pair REFLECTORS 8.8g/set
PD-PEACE-2 PEDAL: 391g/pair REFLECTORS 8.8g/set

2XL

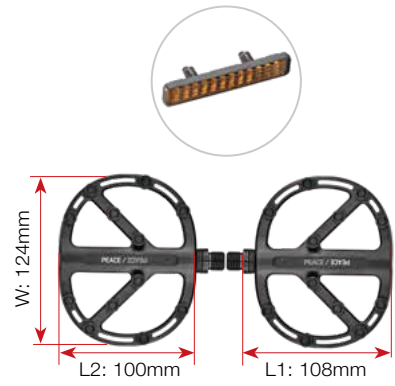

NEW

PD-FOUR-CLOVER-125 (R-PIN) PD-FOUR-CLOVER-125-2 (T-PIN)

107-02

Safety & Anti-slip & Comfort
Innovation concept combine function and safety, let you ride with confidence.

MATERIAL:
Body: AL6061T6 CNC made
Axle: Cr-Mo Cold-Forged
PLATFORM SIZE: 100 x 125 x 108 (L2xWxL1)
PIN: 28 per side
WEIGHT:
PD-FOUR-CLOVER 125
PEDAL: 484g/pair REFLECTORS 8.8g/set
PD-FOUR-CLOVER 125-2
PEDAL: 462g/pair REFLECTORS 8.8g/set

2XL

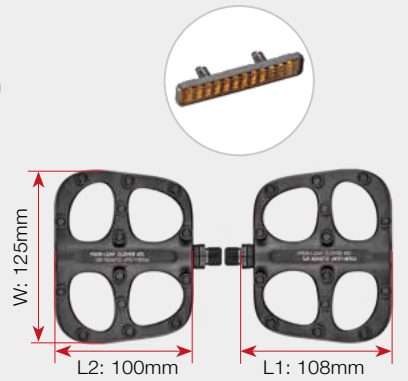

NEW

PDP-150-01

107-03

High-strength nylon pedals with multiple optional pin combinations meet the needs of different riders. The wide platform design enhances pedaling comfort, providing greater stability while riding.

MATERIAL:
Body: Nylon Composite
Axle: Cr-Mo Cold-Forged
PLATFORM SIZE: 108 x 150 x 116 (L2xWxL1)

3XL



NEW

PD-88-150 (R-PIN) PD-88-150-2 (T-PIN)

107-04

Safety & Anti-slip & Comfort
Innovation concept combine function and safety, let you ride with confidence.

MATERIAL:
Body: AL6061-6 CNC made
Axle: Cr-Mo Cold-Forged
PLATFORM SIZE: 100 x 150 x 108 (L2xWxL1)
PIN: 32 per side
WEIGHT:
PD-88-150 PEDAL: 492g/pair REFLECTORS 8.8g/set
PD-88-150-2 PEDAL: 464g/pair REFLECTORS 8.8g/set

3XL

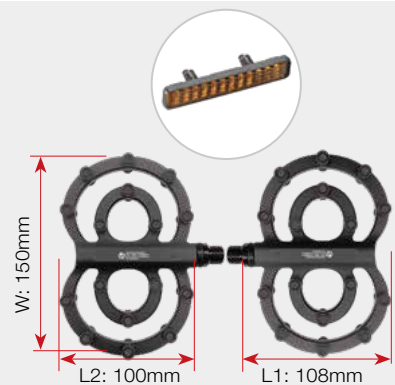

NEW

PD-MOTH-150 (R-PIN) PD-MOTH-150-2 (T-PIN)

107-05

Safety & Anti-slip & Comfort
Innovation concept combine function and safety, let you ride with confidence.

MATERIAL:
Body: AL6061-6 CNC made
Axle: Cr-Mo Cold-Forged
PLATFORM SIZE: 100 x 150 x 108 (L2xWxL1)
PIN: 28 per side
WEIGHT:
PD-MOTH-150 PEDAL: 482g/pair REFLECTORS 8.8g/set
PD-MOTH-150-2 PEDAL: 458g/pair REFLECTORS 8.8g/set

3XL

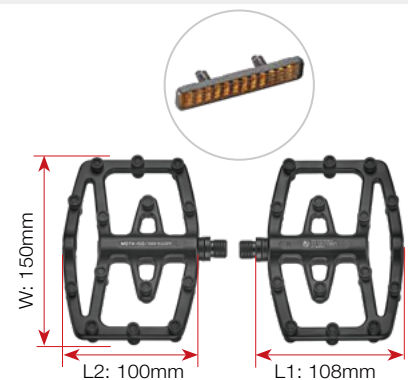

SHIMANO® SPD PLATFORM ADAPTER (ROAD/MTB BIKE)

WHEN USED WITH THE MR-CONTROL ADAPTER PLATE, THE PEDALS ARE AT A MORE REASONABLE ANGLE, MAKING IT EASIER TO ACCESS THE PEDALS.



Pedal surface (Shoes contact surface)

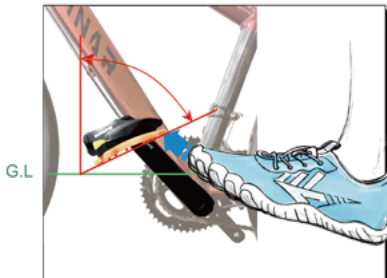

(Other) SPD Pedal Platform Adapter.

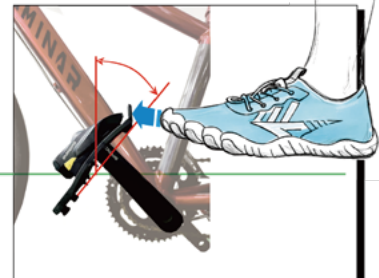

(Mr.control) SPD Pedal Platform Adapter.



NEW

**PDP-AP-2
PDP-AP-6**

108-01

The cleat body is constructed from high-strength fiber-reinforced nylon and paired with ground-contact anti-slip rubber pads to ensure stable pedaling and dependable traction. It is available in 2° and 6° float options to suit different riding styles.

MATERIAL:

Body: High-strength composite plastic / Rubber
Accessories : Carbon Steel

Float: 2° / 6°

Dimensions: 74 x 81 mm (Lx W)

NEW

PDP-AR1

108-02

The patented guide ramp allows you to quickly locate the pedal platform, while the extended, specially contoured design enables fast, easy installation and removal, improving overall pedaling efficiency.

MATERIAL:

Body: Nylon Composite
Y-Locking Plate: Stainless Steel
Counterweight Plate: AL

Dimensions: 139 x 81 mm (Lx W)

NEW

PDP-AR2

108-03

The integrated platform adapter and cleat design requires no additional cleat purchase and installs directly for immediate use; combined with a patented guide ramp, pedaling becomes more stable and efficient.

MODEL: PDP-A1

MATERIALS: High-strength composite plastic

Dimensions: 135 x 84 mm (Lx W)



NEW

PDP-2SL-6

108-04

Patented SPD platform adapter with high strength anti slip resistant cleats, keep the pedal in best optimal angle, bring greater stability and friendly riding experience during training and daily commute, the pedal that meets all your riding needs.

PLATFORM ADAPTER

MATERIAL:

Body: Nylon Composite
Y-Locking Plate: Stainless Steel
Counterweight Plate: AL

CLEAT MATERIAL:

Body: Nylon+fiber / Rubber
Accessories: Carbon Steel

Float: 6°

Dimensions: 139 x 81 mm (Lx W)



NEW

PDP-AR1-M

108-05

[Pedal Platform Adapter] x [SPD Cleats for Mountain bike].

PLATFORM ADAPTER

MATERIAL:

Body: Nylon Composite
Y-Locking Plate: Stainless Steel
Counterweight Plate:
CLEAT MATERIAL: AL
Cr-Mo Steel
(SCM 430 + Cold forged + Heat treated)

Dimensions: 139 x 81 mm (Lx W)



NEW

PDS-M001

108-06

Durable material for Shimano® (mountain bike) SPD pedals.

MATERIAL: Cr-Mo Steel

(SCM 430 + Cold forged + Heat treated)

PEDAL ALL PRODUCTS

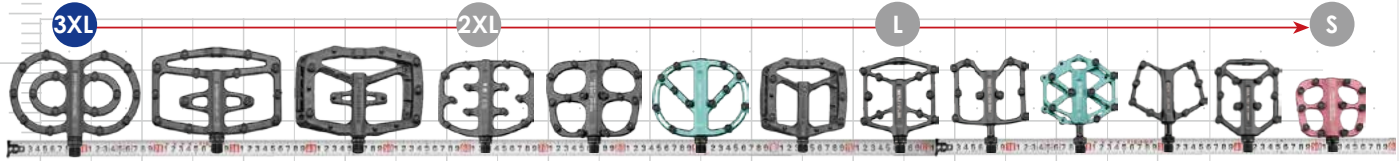

3XL PD-88-150

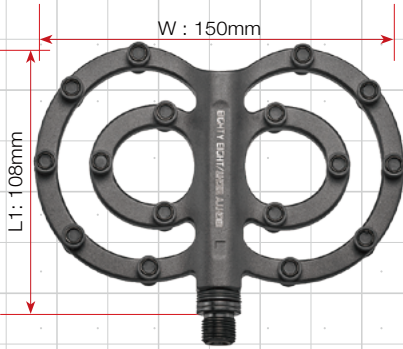

3XL PD-MOTH-150

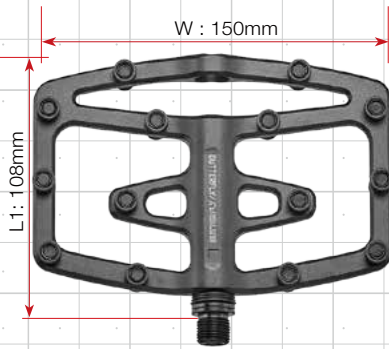

3XL PDP-150-01

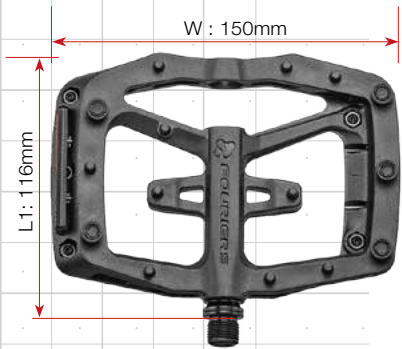

2XL PD-RIB-125

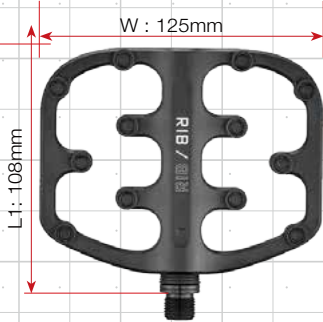

2XL PD-FOUR-CLOVER-125

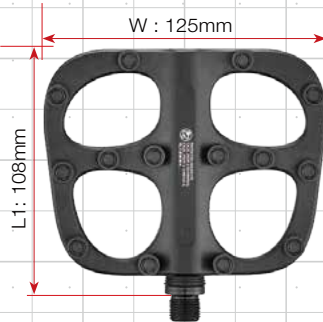

2XL PD-PEACE-125

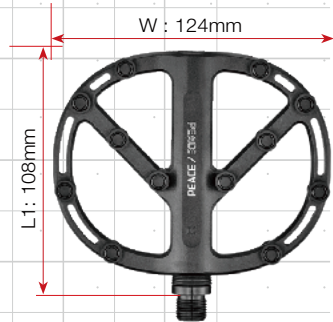

L PDP-110-01



L PD-BEETLE

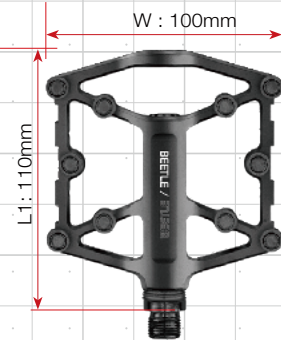

L PD-FRIED-EGG

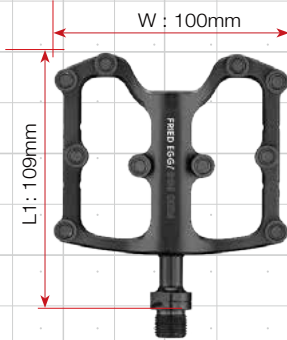

L PD-ROCKET



L PD-OCTOPUS

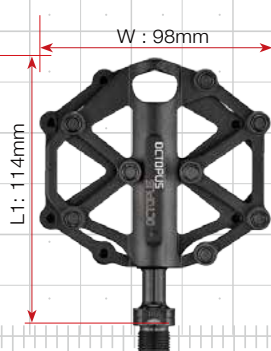

M PD-MODEL-Y80



S PD-FOUR-CLOVER

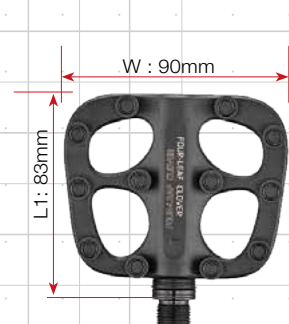

THRU AXLE

QUICK RELEASE

SEAT CLAMP

TOP CAP

HEADSETS PARTS

CRANK SET

CHAINING SYSTEM

ROLLER KIT SERIES

BMX SERIES

CHAINING PARTS

CHAIN GUIDE SYSTEM

BRAKE SYSTEM

SEATPOST

STEM SYSTEM

HANDLEBAR

AEROBAR SYSTEM

COMPUTER MOUNT

CAGE

ACCESSORIES

FITTING EQUIPMENT

PEDALS



Mr.control™

(PRIME AERO)

LAMINAR ENT. CO., LTD.

LAGEAR ENT. CO., LTD.

禾詰企業有限公司 / 上荏企業有限公司

No. 1, Aly. 207, Ln. 92, Fengnan St., Fengyuan Dist.,
Taichung City 420, Taiwan R.O.C.

Tel: +886-4-25391989 Fax: +886-4-25391973

Mail: primaero@ms35.hinet.net

www.mrcontrol-bike.com

