



1991-2026

WE ARE HERE FOR 35 YEARS MORE

- **Employees: 120**
- **Production volume: 8 assembly-lines**
- **We have 3 factorys in Taichung city of Taiwan**
- **Machines Currently in service:**
Swiss lathe, CNC Milling Machine(3 axle, 4 axle, 5 axle), 31 sets, CNC lathe
4 sets Turning & Milling Machine in the factory
- **Subcontract factorys over 100 sets CNC machine capacity**

Company Profile
(English)



Website



Catalog Download



Youtube



Your best OEM, ODM total solution partner

Design / Raw material / Assembly / Packing /Shipping



1 DESIGN

Streamlined design-to-delivery solutions for optimized supply chain performance.

2 RAW MATERIALS

- Extrusion
- Forging
- 3D Forging
- 4-way forging.

3 MACHINING

- Conventional machining
- CNC machining

4 SURFACE TREATMENT

- Sandblasting
- Anodizing
- Laser marking

5 ASSEMBLE

We assemble genuine products, ensuring quality for our customers.

6 SHIPPING

We cooperate with customers in various countries for trade exports.

▼ Aluminum raw material reserves and inventory.



▼ The machine was purchased.



Current situation

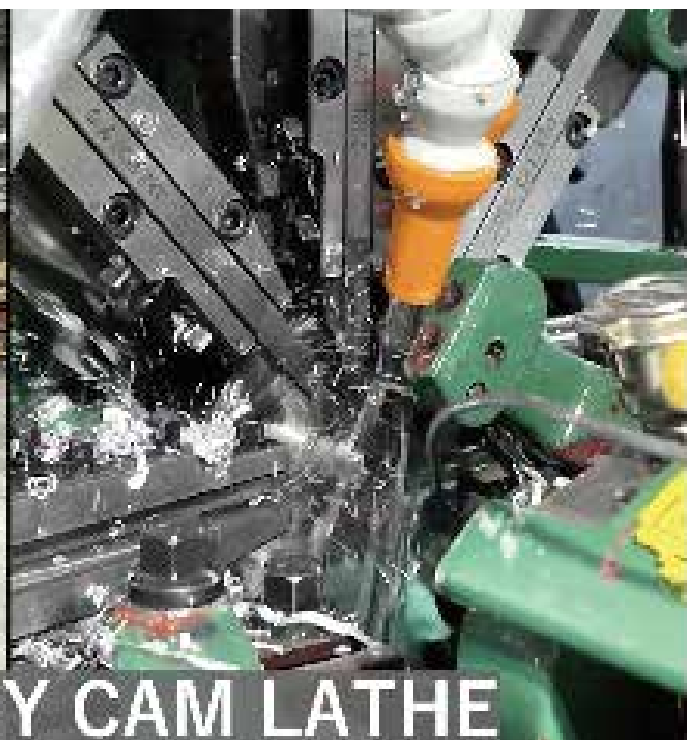

HIGH-EFFICIENCY CAM LATHE



▲ 3+2-Axis Machine



▲ 4-Axis Milling Machine



▲ Automatic assembly Star nut



▼ Automatic Cam Lathe



▼ Swiss Lathe



*Mr.*control
Since 1991



▼ CNC Turning Lathe



▼ Factory 1 located at Fengyuan Dist, Taichung city, 1000 m².





▲ Testing Machine



▲ Testing lab

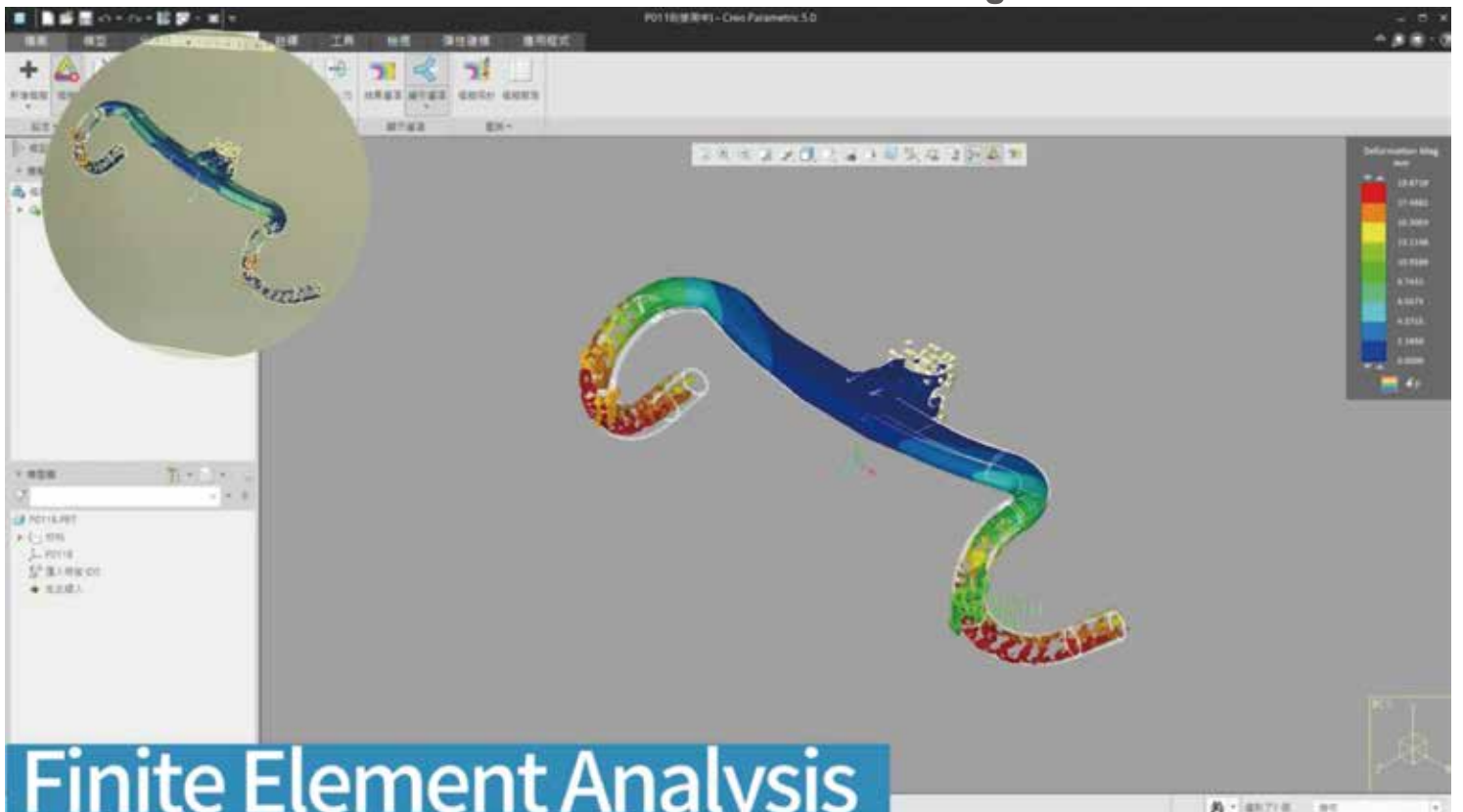

Finite Element Analysis

▼ 3D VL Scanning instrument



▼ Carbon fiber handlebar impact testing machine



▼ Pedal axis endurance testing machine



Carbon Fiber Seat Post Impact Inspection Machine ▲

Our factory 3 in Shengang Fengzhou Science and Technology Industrial Park.



The company has eight production lines capable of supplying the required production volume.



▲ Assembly line

▲ Cam lathe machine

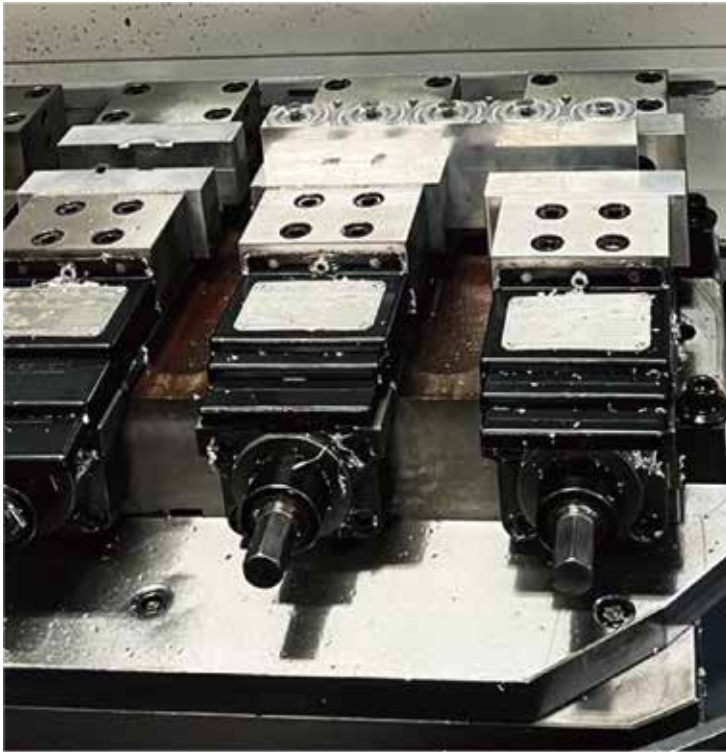

▲ Deburr machine



Sewage treatment equipments, It can separate mud and chemical water. The chemical water is reusable. Sometimes there is too much chemical water, we can use this machine to separate the chemicals from the water.

Chip compactor Advantages



1. By using a chip compactor, **the volume of waste chips can be reduced by up to 97%**, which also reduces the number of truck deliveries, thereby achieving carbon reduction goals.



2. Only less than 5% remaining oil in the compressed block, and the cutting oil can be recycled and reused, with a **recycle rate of over 95%** , thereby achieving economic benefits.



**The farm next to the factory 1,
it is offer to colleague plant vegetable and fruits for free,
and only organic materials can be used.**



THRU AXLE M5 INSIDE

Thru axle for light holder, with M5 and HEX hole in the L/R side, spiry line machined to remove dust and mud.

Custom length thread design available

Multifunctional Same cost .

PATENED, M675821, R.O.C

SPAX-12X-LH-C2

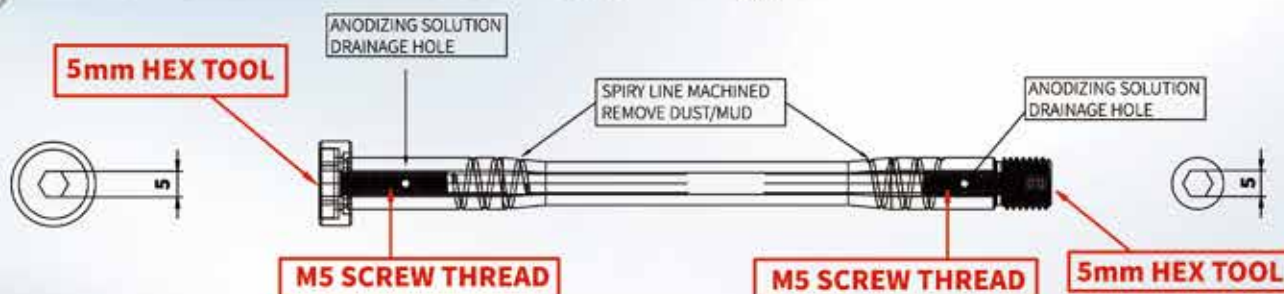

VIDEO



Mr.control

*Mr.*control



HB-STB-M1-SSM



HB-STB-M1



HB-MBR-780-SSM



HB-STB-M35-MR02



HB-STB-M35-MR060



HB-STB-M35-MR090

NEW HANDLEBAR ITEM



NEW

HB-STB-M1-SSM

2027.P65-01

Custom CNC made handlebar integrated light holder with SUPERNOVA® Starstream mini. (Light not included.)

MATERIAL: AL6061-T6

STEM ANGLE: -10°

STEM LENGTH: 70 / 90 / 110mm

WIDTH (HOOD TO HOOD)/WIDTH(DROP TO DROP):

about 380 / 413 ; 400 / 433 ; 420 / 453 ;

440 / 473 ; 460 / 493 (mm)

STEERER TUBE: Ø28.6mm

FORK STACK HEIGHT: 40mm

FLARE: 12°

DROP: 120mm

REACH: 85mm

WEIGHT: about 530g (W: 400mm; Stem L: 90mm)

HEADSET COMPATIBLE WITH TOKEN® A-BOX

CODE: TK155P



Integrated light and top cap.

SUPERNOVA® Starstream mini

Headset compatible with TOKEN® A-BOX Code: TK155P



NEW

HB-MBR-780-SSM

2027.P64-01

Handlebar with light holder. compatible with SUPERNOVA® Starstream mini.

MATERIAL: AL6061-T6

SPEC: Ø31.8 x W780mm

RISE: 20mm

BACK SWEEP: 9 degree

UP SWEEP: 5 degree

Light not include



HANDLEBAR ITEM



Integrated computer mount and top cap.

HB-STB-M1

2027.P65-02

MATERIAL: AL6061-T6
STEM ANGLE: -10°
STEM LENGTH: 70 / 90 / 110mm
WIDTH (HOOD TO HOOD)/WIDTH(DROP TO DROP):
 about 380 / 413 ; 400 / 433 ; 420 / 453 ;
 440 / 473 ; 460 / 493 (mm)
STEERER TUBE: Ø28.6mm
FORK STACK HEIGHT: 40mm
FLARE: 12°
DROP: 120mm
REACH: 85mm
WEIGHT: about 530g (W: 400mm; Stem L: 90mm)
HEADSET COMPATIBLE WITH TOKEN® A-BOX
CODE: TK155P

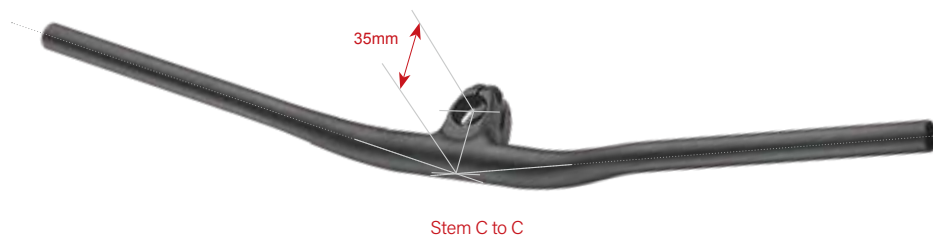

PATENTED

HB-STB-M35-MR02

2027.P64-02

MATERIAL: AL-6061-T6
SPEC: Stem length 35mm
 Bar width 800mm
 For Ø28.6 Steer tube
RISE: 20mm
BACK SWEEP: 8 degree
UP SWEEP: 5 degree

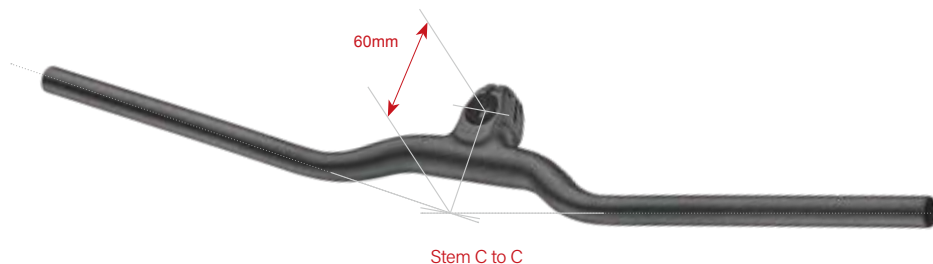

PATENTED

HB-STB-M35-MR060

2027.P64-03

MATERIAL: AL-6061-T6
SPEC: Stem length 60mm,
 Bar width 800mm, For Ø28.6 Steer tube
RISE: 15mm
BACK SWEEP: 8 degree
UP SWEEP: 5 degree

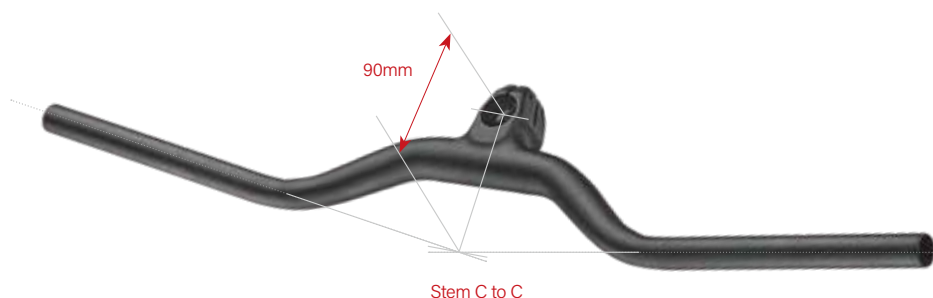

PATENTED

HB-STB-M35-MR090

2027.P64-04

MATERIAL: AL-6061-T6
SPEC: Stem length 90mm
 Bar width 800mm, For Ø28.6 Steer tube
RISE: 5mm
BACK SWEEP: 8 degree
UP SWEEP: 5 degree

PEDALS PEDALS



Traditional Pins.



R-PIN PATENTED, M658172, CN, ZL 2024 2 0439842.6, CN, ZL 2024 2 0148501.3, P.C.T...

Safety & Anti-slip & Comfort.

Innovation concept combine function and safety, let your ride with confidence.

R-PIN :



Black

Blue

Green

Purple

Red

White

Made by heat treatment carbon steel and multi-tool to replace your damaged pins.

T-PIN:



FOR: Alloy Pedal

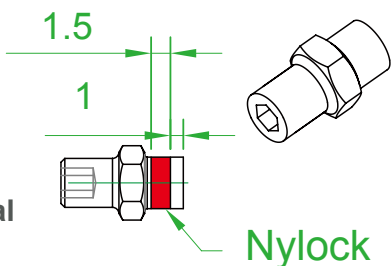

2 functions:
Hex socket 2mm
External hex 5mm

Six different colors Aluminium body :

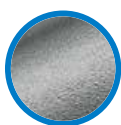

Grey



black



orange



pink

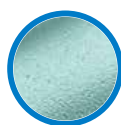

blue

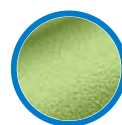

green

Website



Youtube



NEW

PD-FOUR-CLOVER (R-PIN) PD-FOUR-CLOVER-2 (T-PIN)

2027.P105-01

Safety & Anti-slip & Comfort
Innovation concept combine function and safety, let your ride with confidence.

MATERIAL:

Body: AL6061T6 CNC made

Axle: Cr-Mo Cold-Forged

PLATFORM SIZE: 75 x 90 x 83 (L2xWxL1)

PIN: 24 per side

WEIGHT:

PD-FOUR-CLOVER PEDAL 377g/pair REFLECTORS 8.8g/set

PD-FOUR-CLOVER-2 PEDAL 355g/pair REFLECTORS 8.8g/set



S

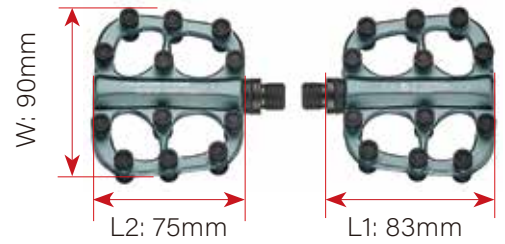

NEW

PD-MODEL-Y80 (R-PIN) PD-MODEL-Y80-2 (T-PIN)

2027.P105-02

Safety & Anti-slip & Comfort
Innovation concept combine function and safety, let your ride with confidence.

MATERIAL:

Body: AL6061T6 CNC made

Axle: Cr-Mo Cold-Forged

PLATFORM SIZE: 100 x 80 x 108 (L2xWxL1)

PIN: 20 per side

WEIGHT:

PD-MODEL Y80 PEDAL 350g/pair REFLECTORS 8.8g/set

PD-MODEL Y80-2 PEDAL 332g/pair REFLECTORS 8.8g/set



M

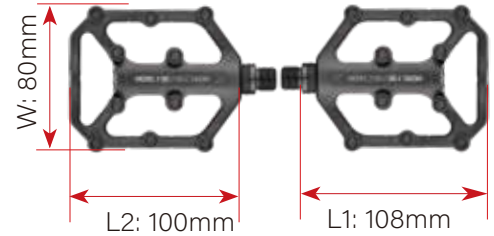

NEW

PD-ROCKET (R-PIN) PD-ROCKET-2 (T-PIN)

2027.P105-03

Safety & Anti-slip & Comfort
Innovation concept combine function and safety, let your ride with confidence.

MATERIAL:

Body: AL6061T6 CNC made

Axle: Cr-Mo Cold-Forged

PLATFORM SIZE: 82 x 100 x 106.5 (L2xWxL1)

PIN: 16 per side

WEIGHT: PD-ROCKET PEDAL 278g/pair REFLECTORS 8.8g/set

PD-ROCKET-2 PEDAL 266g/pair REFLECTORS 8.8g/set



L

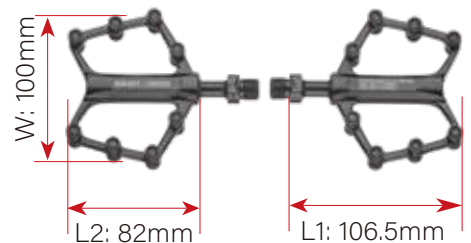

NEW

PD-BEETLE (R-PIN)

PD-BEETLE-2(T-PIN) 2027.P106-01

Safety & Anti-slip & Comfort
Innovation concept combine function and safety, let you ride with confidence.

MATERIAL:

Body: AL6061T6 CNC made

Axle: Cr-Mo Cold-Forged

PLATFORM SIZE: 100 x 100 x 110 (L2xWxL1)

PIN: 20 per side

WEIGHT:

PD-BEETLE

PEDAL: 370g/pair

REFLECTORS 8.8g/set

PD-BEETLE-2

PEDAL: 338g/pair

REFLECTORS 8.8g/set



L

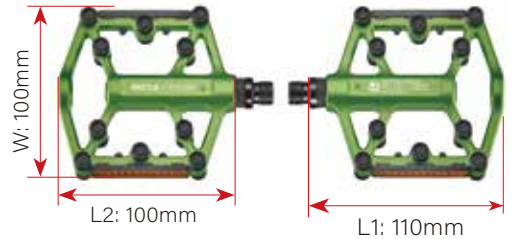

NEW

PD-FRIED-EGG (R-PIN)

PD-FRIED-EGG-2 (T-PIN) 2027.P106-02

Safety & Anti-slip & Comfort
Innovation concept combine function and safety, let you ride with confidence.

MATERIAL:

Body: AL6061T6 CNC made

Axle: Cr-Mo Cold-Forged

PLATFORM SIZE: 86 x 100 x 109 (L2xWxL1)

PIN: 20 per side

WEIGHT:

PD-FRIED EGG

PEDAL: 340g/pair

REFLECTORS 8.8g/set

PD-FRIED EGG-2

PEDAL: 322g/pair

REFLECTORS 8.8g/set



L

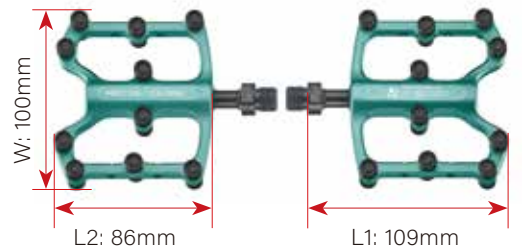

NEW

PD-OCTOPUS (R-PIN)

PD-OCTOPUS-2 (T-PIN) 2027.P106-03

Safety & Anti-slip & Comfort
Innovation concept combine function and safety, let you ride with confidence.

MATERIAL:

Body: AL6061T6 CNC made

Axle: Cr-Mo Cold-Forged

PLATFORM SIZE: 89 x 98 x 114 (L2xWxL1)

PIN: 16 per side

WEIGHT:

PD-OCTOPUS

PEDAL: 330g/pair

REFLECTORS 8.8g/set

PD-OCTOPUS-2

PEDAL: 318g/pair

REFLECTORS 8.8g/set



L

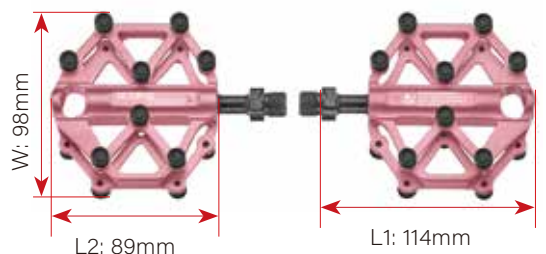

NEW

PDP-110-01

2027.P106-04

High-strength nylon pedals with multiple optional pin combinations meet the needs of different riders. The wide platform design enhances pedaling comfort, providing greater stability while riding.

MATERIAL:

Body: Nylon Composite

Axle: Cr-Mo Cold-Forged

PLATFORM SIZE: 108 x 116 x 116 (L2xWxL1)



NEW

PD-RIB-125 (R-PIN) PD-RIB-125-2 (T-PIN)

2027.P106-05

Safety & Anti-slip & Comfort
Innovation concept combine function and safety, let your ride with confidence.

MATERIAL:

Body: AL6061T6 CNC made

Axle: Cr-Mo Cold-Forged

PLATFORM SIZE: 100 x 125 x 108 (L2xWxL1)

PIN: 24 per side

WEIGHT:

PD-RIB PEDAL: 437g/pair REFLECTORS 8.8g/set

PD-RIB-2 PEDAL: 417g/pair REFLECTORS 8.8g/set



NEW

PD-PEACE-125 (R-PIN) PD-PEACE-125-2 (T-PIN)

2027.P107-01

Safety & Anti-slip & Comfort
Innovation concept combine function and safety, let you ride with confidence.

MATERIAL:

Body: AL6061T6 CNC made

Axle: Cr-Mo Cold-Forged

PLATFORM SIZE: 100 x 124 x 108 (L2xWxL1)

PIN: 24 per side

WEIGHT:

PD-PEACE PEDAL: 410g/pair REFLECTORS 8.8g/set

PD-PEACE-2 PEDAL: 391g/pair REFLECTORS 8.8g/set

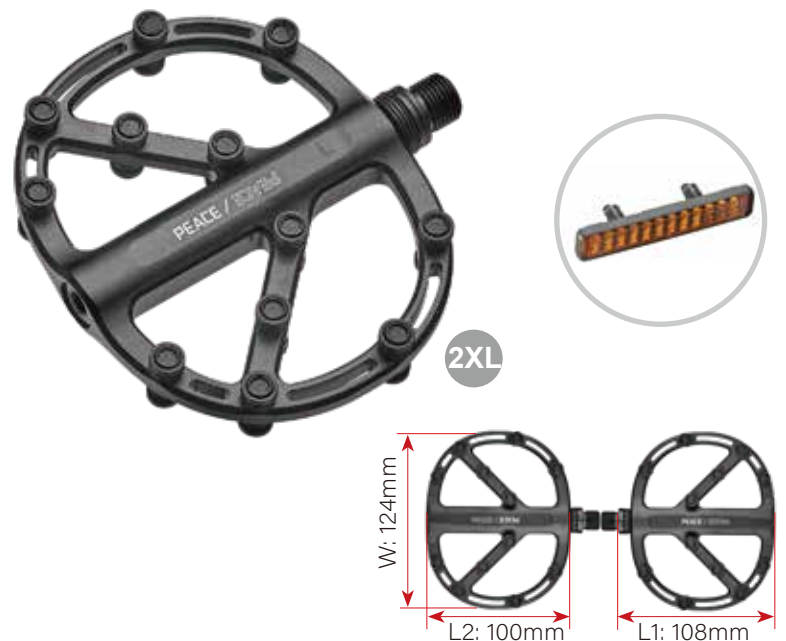

NEW

PD-FOUR-CLOVER-125 (R-PIN) PD-FOUR-CLOVER-125-2(T-PIN)

2027.P107-02

Safety & Anti-slip & Comfort
Innovation concept combine function
and safety, let you ride with confidence.

MATERIAL:

Body: AL6061T6 CNC made

Axle: Cr-Mo Cold-Forged

PLATFORM SIZE: 100 x 125 x 108 (L2xWxL1)

PIN: 28 per side

WEIGHT:

PD-FOUR-CLOVER 125

PEDAL: 484g/pair REFLECTORS 8.8g/set

PD-FOUR-CLOVER 125-2

PEDAL: 462g/pair REFLECTORS 8.8g/set



2XL

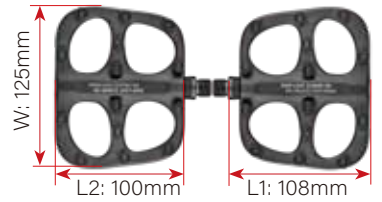

NEW

PDP-150-01

2027.P107-03

High-strength nylon pedals with multiple optional pin combinations meet the needs of different riders. The wide platform design enhances pedaling comfort, providing greater stability while riding.

MATERIAL:

Body: Nylon Composite

Axle: Cr-Mo Cold-Forged

PLATFORM SIZE: 108 x 150 x 116 (L2xWxL1)



3XL

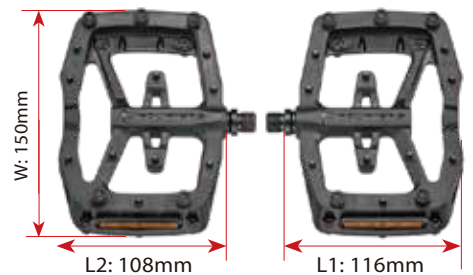



3XL



NEW

PD-88-150 (R-PIN)
PD-88-150-2(T-PIN)

2027.P107-04

Safety & Anti-slip & Comfort
 Innovation concept combine function
 and safety, let you ride with confidence.

MATERIAL:

Body: AL6061-6 CNC made

Axle: Cr-Mo Cold-Forged

PLATFORM SIZE: 100 x 150 x 108 (L2xWxL1)

PIN: 32 per side

WEIGHT:

PD-88-150 PEDAL: 492g/pair REFLECTORS 8.8g/set

PD-88-150-2 PEDAL: 464g/pair REFLECTORS 8.8g/set

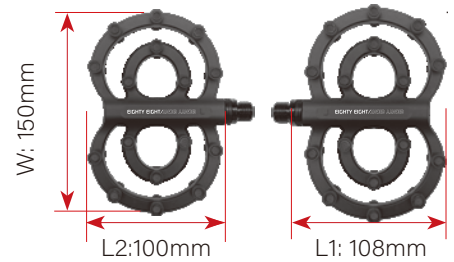

3XL



NEW

PD-MOTH-150 (R-PIN)
PD-MOTH-150-2(T-PIN)

2027.P107-05

Safety & Anti-slip & Comfort
 Innovation concept combine function
 and safety, let you ride with confidence.

MATERIAL:

Body: AL6061-6 CNC made

Axle: Cr-Mo Cold-Forged

PLATFORM SIZE: 100 x 150 x 108 (L2xWxL1)

PIN: 28 per side

WEIGHT:

PD-MOTH-150 PEDAL: 482g/pair REFLECTORS 8.8g/set

PD-MOTH-150-2 PEDAL: 458g/pair REFLECTORS 8.8g/set

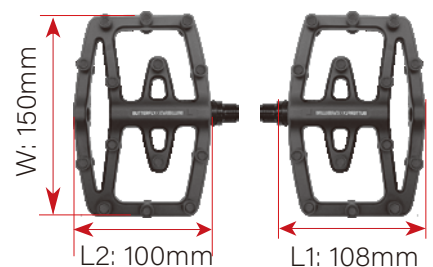

SHIMANO® SPD PLATFORM ADAPTER (ROAD/MTB BIKE)

WHEN USED WITH THE MR-CONTROL ADAPTER PLATE, THE PEDALS ARE AT A MORE REASONABLE ANGLE, MAKING IT EASIER TO ACCESS THE PEDALS.



Pedal surface (Shoes contact surface)

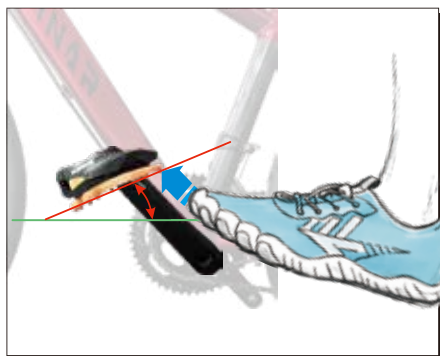

(Other) SPD Pedal Platform Adapter.

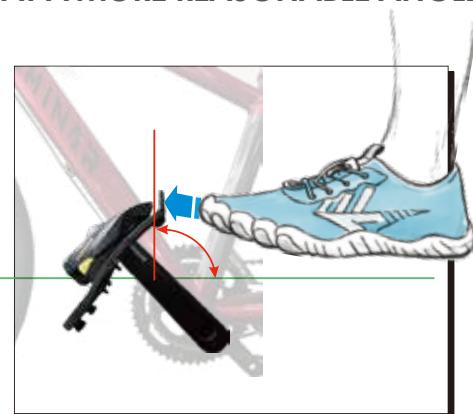

(Mr.control) SPD Pedal Platform Adapter.

NEW

PDS-M001

2027.P108-06

Durable material for Shimano® (mountain bike) SPD pedals.

MATERIAL: Cr-Mo Steel
(SCM 430 + Cold forged + Heat treated)



NEW

PDP-LK-4.5

2027.NEW

Durable material for Look® KEO pedals, and paired with ground-contact anti-slip rubber pads traction.

MATERIAL:
Body: Nylon+Fiber / Rubber
Accessories: Carbon Steel
FLOAT: 4.5°
DIMENSIONS: 68x70(LxW)



NEW

PDP-AP-2
PDP-AP-6

2027.P108-01

The cleat body is constructed from high-strength fiber-reinforced nylon and paired with ground-contact anti-slip rubber pads to ensure stable pedaling and dependable traction. It is available in 2° and 6° float options to suit different riding styles.

MATERIAL:
Body: High-strength composite plastic / Rubber
Accessories : Carbon Steel
FLOAT: 2° / 6°
DIMENSIONS: 74 x 81 mm (LxW)



NEW

PDP-2KEO-4.5

2027.NEW

[Pedal Platform Adapter]x[Look® KEO Cleats]

PLATFORM ADAPTER

MATERIAL:
Body: Nylon Composite
Y-Locking Plate: Stainless Steel
Counterweight Plate: AL
CLEAT MATERIAL
Body: Nylon+Fiber / Rubber
Accessories: Carbon Steel
FLOAT: 4.5°
DIMENSIONS: 139x81(LxW)



New spd platform adapter

NEW

PDP-AR1

2027.P108-02

The patented guide ramp allows you to quickly locate the pedal platform, while the extended, specially contoured design enables fast, easy installation and removal, improving overall pedaling efficiency.

MATERIAL:

Body: Nylon Composite

Y-Locking Plate: Stainless Steel

Counterweight Plate: AL

DIMENSIONS: 139 x 81 mm (Lx W)



NEW

PDP-AR2

2027.P108-03

The integrated platform adapter and cleat design requires no additional cleat purchase and installs directly for immediate use; combined with a patented guide ramp, pedaling becomes more stable and efficient.

MATERIAL: High-strength composite plastic

DIMENSIONS: 135 x 84 mm (Lx W)

COMPATIBILITY: Shimano SPD-SL



NEW

PDP-AR3

2027.NEW

The integrated platform adapter and cleat design requires no additional cleat purchase and installs directly for immediate use; combined with a patented guide ramp, pedaling becomes more stable and efficient.

MATERIAL: High-strength composite plastic

DIMENSIONS: 133 x 83 mm (Lx W)

COMPATIBILITY: Look KEO



NEW

PDP-2SL-6

2027.P108-04

Patented SPD platform adapter with high strength anti slip resistant cleats, keep the pedal in best optimal angle, bring greater stability and friendly riding experience during training and daily commute, the pedal that meets all your riding needs.

PLATFORM ADAPTER

MATERIAL:

Body: Nylon Composite

Y-Locking Plate: Stainless Steel

Counterweight Plate: AL

CLEAT MATERIAL:

Body: Nylon+fiber / Rubber

Accessories: Carbon Steel

Float: 6°

DIMENSIONS: 139 x 81 mm (Lx W)



NEW

PDP-AR1-M

2027.P108-05

[Pedal Platform Adapter] x [SPD Cleats for Mountain bike].

PLATFORM ADAPTER

MATERIAL:

Body: Nylon Composite

Y-Locking Plate: Stainless Steel

Counterweight Plate: AL

CLEAT MATERIAL:

Cr-Mo Steel

(SCM 430 + Cold forged + Heat treated)

DIMENSIONS: 139 x 81 mm (Lx W)



PEDAL ALL PRODUCTS



3XL

PD-88-150

W : 150mm

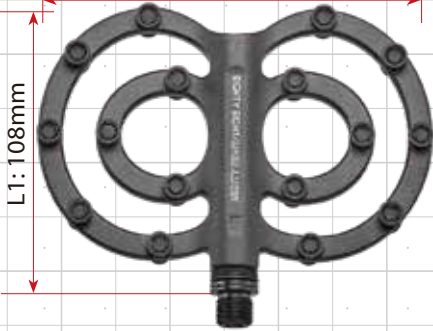

3XL

PD-MOTH-150

W : 150mm

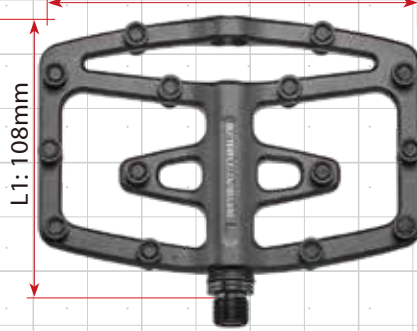

3XL

PDP-150-01

W : 150mm



2XL

PD-RIB-125

W : 125mm



2XL

PD-FOUR-CLOVER-125

W : 125mm

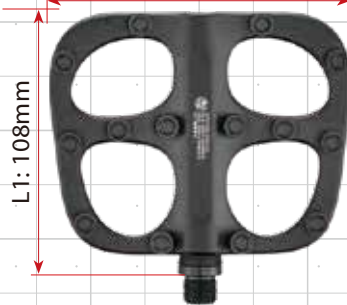

2XL

PD-PEACE-125

W : 124mm

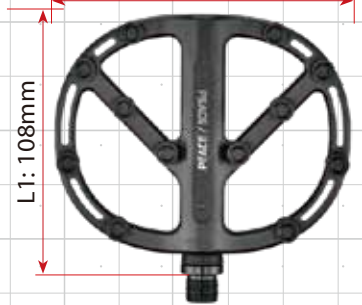

L

PDP-110-01

W : 116mm



L

PD-BEETLE

W : 100mm



L

PD-FRIED-EGG

W : 100mm



L

PD-ROCKET

W : 100mm



L

PD-OCTOPUS

W : 98mm

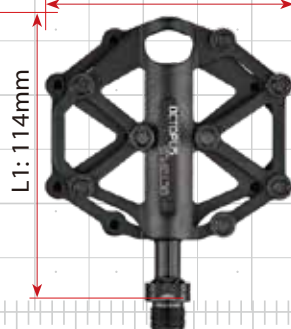

M

PD-MODEL-Y80

W : 80mm

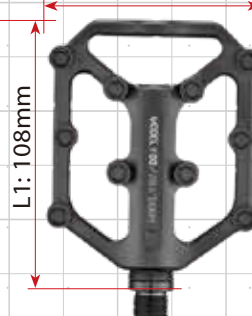

S

PD-FOUR-CLOVER

W : 90mm



TOP SALE ITEM

THRU AXLE

NEW PATENED, M675821, R.O.C

SPAX-12X-LH-C2

2027.P07-01

Thru axle for light holder, with M5 and HEX hole in the L/R side, spiry line machined to remove dust and mud.

MATERIAL: AXLE AL6066-T6

SPEC: Refer to the specification table.

OPTION: THREAD M12X1.0/M12X1.5/M12X1.75

Custom length thread design available



Not include light holder.



Axle length	Thread	Thread length
160.8mm	M12*1.5	12mm
165mm-170mm	M12*1.5	15mm
165mm-170mm	M12*1.0	15mm
160mm-165mm	M12*1.5	15mm
160mm-165mm	M12*1.0	15mm
162.5mm	M12*1.5	13mm
165.5mm	M12*1.0	12mm

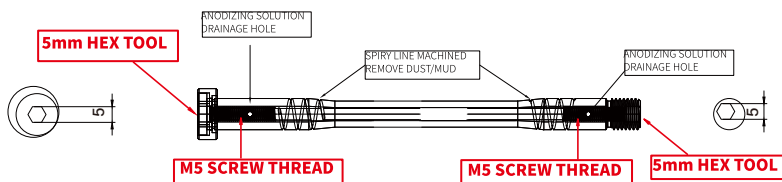

BEST SELLER

SPAX-12X-M0-C2

2027.P07-03

MATERIAL: AL6066-T6

SPEC: Refer to the specification table.

OPTION: Thread M12 x 1.0 / M15 x 1.5

Custom length thread design available



BEST SELLER

SPAX-M16-12X-C2

2027.P07-04

MATERIAL: AL6066-T6

SPEC: Refer to the specification table.

OPTION: Thread M12 x 1.0 / M12 x 1.5 / M12 x 1.75

Custom length thread design available



SPAX-121-C2

SPAX-66-C2

2027.P07-05

MATERIAL: AL7075-T6 / AL6066-T6

SPEC: Refer to the specification table.

OPTION: Thread M12 x 1.0 / M15 x 1.5

Custom length thread design available

12mm / 15mm axle custom design available



2025/10

NEW

QR-SPL-LHF

2027.P13-06

QR axle with light holder for hollow front thru axle system.

MATERIAL : AL6061-T6

AXLE: Cr-Mo axle

COLOR : AS ORDER

Custom length thread design available.



QR-TAK-12X

2027.P08-02

Step-in System Lever removable.

With 4mm allen key for stem bolt / clamp bolt.

MATERIAL OF LEVER: Carbon Injection

MATERIAL OF AXLE: AL6066-T6

SPEC: Refer to the specification table.

OPTION: Thread M12 x 1.0 / M15 x 1.5

Custom length thread design available



QR-11-E

2027.P14-03

With plastic nut + steel.

QR-11-SE for seattube

QR-11-EF / 100 for front

QR-11-ER / 135 for MTB rear

QR-11-ERC / 130 for Road bike rear



BEST SELLER

QR-72E

2027.P15-01

Cr-Mo axle / Alloy lever.

WEIGHT: 125g/pair (ROAD) / 126.5g/pair (MTB) / 41.5g/pcs (S)

QR-72E-S / for seattube

QR-72E-F / 100 for front

QR-72E-R / 135 for MTB rear

QR-72E-RC / 130 for Road bike rear

* The product's price is Ex Works price (EXW).



TOP SALE ITEM

SEAT CLAMP



OVER SIZE **BEST SELLER**

CL-CV

2027.P17-01

Extend rubber cover, to prevent dust permeate in to seattube.
Chamfer edge & oval hole design to protect carbon frame & seatpost.

MATERIAL: AL6061-T6 clamp with NBR cover

SPEC:

Ø27.2 seatpost - Ø31.8 seattube
Ø31.6 seatpost - Ø34.9 seattube
Ø27.2 seatpost - Ø34.9 seattube
Ø30.9 seatpost - Ø34.9 seattube
Ø33.9 seatpost - Ø38.1 seattube
Ø34.9 seatpost - Ø38.6 seattube
H: 16mm (12mm insert)

COLOR:

Clamp: Black anodize
Cover: Black, Red, Blue, Apple Green, Orange, Pink, White, Yellow



OVER SIZE **BEST SELLER**

CL-FJ21

2027.P17-02

MATERIAL: AL6066 CNC made
SPEC: Ø28.6, Ø31.8, Ø34.9, Ø38.6
H: 14mm

COLOR: As Order

STANDARD: Blast anodize

OPTION: H 16.5mm

Oval hole design for carbon fiber



OVER SIZE **BEST SELLER**

CL-9872E-QT

2027.P25-02

MATERIAL: AL6061

With longer lever (72mm)

SPEC: Ø28.6, Ø31.8, Ø34.9,
Ø38.6, Ø40

H: 13mm

COLOR: As Order



OVER SIZE **BEST SELLER**

CL-07P

2027.P18-02

MATERIAL: AL6061 CNC made
SPEC: Ø25.4, Ø28.6, Ø31.8,
Ø34.9, Ø38.1, Ø38.6

H: 15mm

COLOR: As Order

WEIGHT: 22.5g

OPTION: Oval hole for carbon

Special chamfer for carbon frame



OVER SIZE **BEST SELLER**

CL-96QT

2027.P25-03

MATERIAL: AL6061

SPEC: Ø25.4, Ø28.6, Ø31.8,
Ø34.9, Ø37, Ø38.1, Ø38.6, Ø40

H: 13mm

COLOR: As Order



BEST SELLER

CL-FR

2027.P20-08

MATERIAL: AL6061

SPEC: Ø28.6, Ø29.8, Ø31.8, Ø34.9
H: 13.5mm

COLOR: As Order

STANDARD: Blast anodize

M5 Thread for carrier



BEST SELLER

CL-98QT

2027.P25-04

MATERIAL: AL6061

SPEC: Ø25.4, Ø28.6, Ø31.8, Ø34.9
H: 13mm

COLOR: As Order

TOP SALE ITEM

TOP CAP

BEST SELLER

TK-001S

2027.P27-01



MATERIAL: AL6061-T6
WEIGHT: 17.5g/pcs (W/O star nut)
SIZE: 1" , 1-1/8" or 1-1/2"
OPTION: 1. Stainless screw
2. Star nut



BEST SELLER

AR-28.6-H

2027.P30-02

Alloy spacer.

SPEC: AR-28.6-H (ID $\varnothing 28.8 \pm 0.2$ x OD $\varnothing 32.5, \varnothing 33, \varnothing 34, \varnothing 35, \varnothing 36$)
H: As Order
COLOR: As Order



BEST SELLER

TK-TD18

2027.P27-04

MATERIAL: AL6061-T6
WEIGHT: 13.3g/pcs (W/O star nut)
SIZE: 1-1/8"
COLOR: Sand blast anodize with star nut
OPTION: AL7075-T73 screw



BEST SELLER

AC-28.6-H

2027.P30-04

Carbon spacer.

SPEC: AC-28.6-H (ID $\varnothing 28.8 \pm 0.2$ x OD $\varnothing 34$)
H: As Order
COLOR: 3K, UD



TK-TD-C

2027.P27-03

MATERIAL: Carbon
WEIGHT: 11.5g/pcs (W/O star nut)
SIZE: 1-1/8"
With star nut



BEST SELLER

LIGHT WEIGHT

AE-28.6-H

2027.P30-01

Alloy spacer.

P.A.T ED
SPEC: AE-28.6-H (ID $\varnothing 28.8 \pm 0.2$ x OD $\varnothing 34$)
H: As Order
COLOR: As Order



STAR NUT-29

2027.P27-10



For $\varnothing 31.8$ Alloy / Cr-Mo fork.

SPEC: $\varnothing 28.8$
WEIGHT: 10.5g/pcs



BEST SELLER

ACE-28.6-H

2027.P31-02

Carbon spacer.

P.A.T ED
SPEC: ACE-28.6-H (ID $\varnothing 28.8$ x OD $\varnothing 34$)
H: As Order
COLOR: 3K, UD



* The product's price is Ex Works price (EXW).

TOP SALE ITEM

SPAX-UA-1-142 (168mm)

BEST SELLER

SPAX-UA-1-148 (176mm)

2027.P7-02

Thru axle with UDH hanger set.

MATERIAL: Axle / High Strength AL6066-T6
Hanger / High Strength AL6066-T6
/ Nylon12+Glass Fiber

Custom length thread design available.



BEST SELLER

UDH-HANGER

2027.P99-03

The Universal Derailleur Hanger.

MATERIAL: AL6066-T6 BODY / NYLON FRAME
WEIGHT: 27g/pcs



▲ Main body Alloy co-molded with Nylon destructive test.
"Passed the torque test of 40N.m"

NEW

UDH-HANGER-SH

2027.P99-02

Universal Derailleur Hanger for SHIMANO system.

MATERIAL: AL6061-T6 BODY / 6066-T6 BOLT
COLOR: Black
WEIGHT: 34.5g /set



NEW

UDH-HANGER-AL

2026.P99-04

Hanger never get damaged.

Material : Hanger and Washer:AL-6061-T6
Bolt: AL-6066-T6



NEW

UDH-HANGER-P2

2027.P99-05

Featuring an aluminum alloy axle with the original nylon plastic styling outline preserved.

MATERIAL:
Body / Bolt: AL6066-T6
Frame shape: Nylon



UDH-HANGER

SUITABLE FOR SHIMANO[®] SPEC

NEW

SPAX-DM-1 (Shimano[®] Bike frame width was underleased.)

2027.NEW



Thru axle with UDH-HANGER-SDA set.

MATERIAL: Axle / High Strength AL6066-T6
Hanger and Washer / AL6061-T6
Bolt / High Strength AL6066-T6

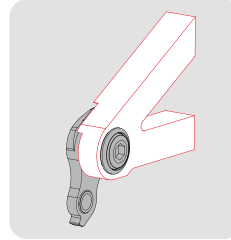

NEW

UDH-HANGER-SDA

2027.NEW

Compatible with SHIMANO[®] upcoming UDH interface. For road and gravel bike.

MATERIAL:
Hanger and Washer: AL6061-T6
Bolt: AL6066-T6



NEW

UDH-HANGER-SDM

2027.NEW

Compatible with SHIMANO[®] upcoming UDH direct mount interface. For road and gravel bike.

MATERIAL:
Hanger and Washer: AL6061-T6
Bolt: AL6066-T6



BEST SELLER

SPAX-12X-M0-C2

2027.P7-03

MATERIAL: AL6066-T6 axle
SPEC: Refer to the specification table.
OPTION: Thread M12 x 1.0 // M14 x 1.5 // M15 x 1.5
Custom length thread design available

12mm axle with CNC cut to save weight and spiral helicoid cut to prevent axle stuck with dust and mud and prevent the axle stuck in the hub.



Riveting workieces



Click Me

32

禾植企業有限公司
LAMINAR ENT. CO., LTD.

台中市豐原區豐原路42巷367-1號
TEL: 886-4-25319189 FAX: 886-4-25319173
Email: palmen@ms35.hinet.net

材料測試試驗報告

- | | |
|-----------------------------|-------------------------------------|
| 1. 公司名稱: 禾植企業有限公司 | 8. 試件名稱: sample |
| 2. 操作者: Sam | 9. 標距距離: 50.000mm |
| 3. 試驗機號: SPAX 12X-M0-Sample | 10. 試件表面: 不規則 |
| 4. 試驗日期: 2021年3月12日 | 11. 試件厚度: 不規則 |
| 5. 試驗溫度: 25C | 12. 試件厚度: 400.000mm ² |
| 6. 試驗型態: 拉力試驗 | 13. 標距: 50 |
| 7. 試驗標準: 心軸拉力破壞 | 14. 變形係數: 148.850kg/mm ² |
| | 15. 備註: |

	荷重(kg)	伸長(mm)	應力(kg/mm ²)	應變(%)
最大	1828.9	1.82	4.572	3.64
斷裂	1111.7	1.86	2.779	3.72
編次	00	0.00	0.000	0.00

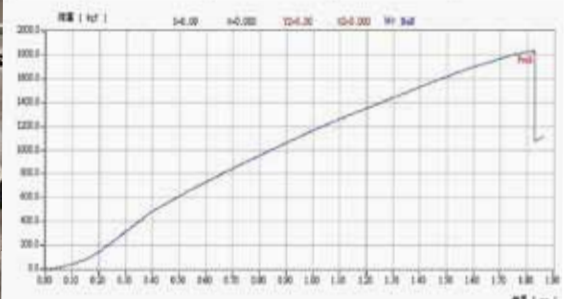

NEW

SPAX-12X-R2RL

2027.P9-01

For direct mount hanger protector, protect the dropout from side impacts, strengthens interface between derailleur and frame, with custom length thru axle.

MATERIAL: AL6061-T6
COLOR: Sand blast black
SPEC: Custom length thread design available
Axle length 160.8mm pitch M12*1.5 fit 2023 Giant® TCR/PROPEL/DEFY.



BEST SELLER

QR-TAK-12X/15X-C2

2027.P8-02

Step-in System Lever removable.
With 4mm allen key for stem bolt / clamp bolt.

MATERIAL OF LEVER: Carbon Injection
MATERIAL OF AXLE: AL6066-T6
SPEC: Refer to the specification table.
OPTION: Thread M12 x 1.0 / / M14 x 1.5 / M15 x 1.5
Custom length thread design available

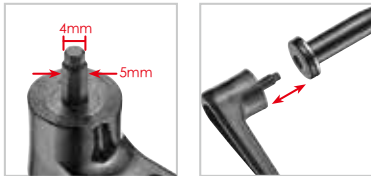

P. A. T. ED



BEST SELLER

SPAX-M16-12X-C2

2027.P7-04

MATERIAL: AL6066-T6
SPEC: Refer to the specification table.
OPTION: Thread M12 x 1.0/ M12 x 1.5 / M12 x 1.75
Custom length thread design available



SPAX-TL-12X

BEST SELLER

2027.P8-01

Integrated 6mm allen key system with 12mm / 15mm hollow axle, with cover to keep tool in position.

MATERIAL: AL6066-T6 axle
SPEC: Refer to the specification table.
OPTION: Thread M12 x 1.0 / / M14 x 1.5 / M15 x 1.5
Custom length thread design available
12mm / 15mm axle custom design available



P.A.T. ED

SPAX-12X-R2R

2027.P9-02

Protects the dropout from side impacts,
Strengthens interface between derailleur
and frame, with Custom length thru axle.

MATERIAL: AL6061-T6
COLOR: Sandblast black
SPEC: Custom length thread design available
Axle length 160.8mm Pitch M12*1.5
fit 2023 Giant TCR & PROPEL & DEFY.



UDH-R2R

2027.P9-03

For UDH hanger system, protects the dropout
from side impacts, strengthen interface
between derailleur and frame.

Hanger material : High strength AL 6066-T6
Nylon12+Glass Fiber

Protector material : AL 6061T6

Color : black

Weight : 66g



UDH-R2R

QR-SM-TAR

2027.P11-02

For rear $\varnothing 12$ mm thru axle.
Include width adjuster: 142, 148, 150mm.

MATERIAL: AL6061-T6

WEIGHT: 91g/set (with adapter)



BEST SELLER

QR-SM-PLR-142E/ 148E / 150E

2027.P11-01

Handy chain tension device for travelling.
For rear $\varnothing 12$ mm thru axle frame.

MATERIAL: Nylon

SPEC: Width 142 / 148 / 150mm

WEIGHT: 46g/pcs (142E)



QR-SM-TAF012 /TAF015/ TAF0151/TAF020

2027.P11-03

For fork $\varnothing 12 \times 100$ thru axle
 $\varnothing 15 \times 100$ thru axle
 $\varnothing 15 \times 110$ thru axle
 $\varnothing 20 \times 110$ thru axle

MATERIAL: AL6061-T6

WEIGHT: 33g/pcs (TAF015)

44g/pcs (TAF020)



NEW

CH-ES3-LW

2027.P49-01

Light weight design bash guard for single speed.

MATERIAL: AL6061-T6
SPEC: ISCG-05
RANGE: 28T-36T
COLOR: AS ORDER
WEIGHT: 45g



CH-G23-MED2

2027.P48-04

For MTB 1X system drivetrain with bash guard.

MATERIAL: AL6061-T6/ Nylon
SPEC: ISCG 05
TEETH: 28-34T
COLOR: As Order



CH-DLG9T

2027.P48-01

Chain guard with pulley style and bashguard.

MATERIAL: AL6061-T6
SPEC: ISCG 05
TEETH: 28-34T
COLOR: Black



CH-DLR

2027.P48-02

Chain guard with roller style and bashguard.

MATERIAL: AL6061-T6/ NYLON
SPEC: ISCG 05
TEETH: 28-34T
COLOR: Black



CH-CLD

2027.P51-01

MATERIAL: AL6061-T6
SPEC: Clamp \varnothing 34.9,
 \varnothing 31.8, \varnothing 28.6 mm
COLOR: Black



NEW
CH-MTS-MED2

2027.P47-03

Chain guide for 1X system ,
BB mount version.

MATERIAL: ARM AL6061T6 / UPPER
GUARD GV5H
SPEC: SB BLACK
RANGE: 30T-38T

Include spacers for chainline adjust.



CH-BOSCX-MED2
CH-BOSCX-MED
CH-BOSCX-MINI

2027.P46-02

For BOSCH® CX chain guide.

MATERIAL: AL6061-T6
SPEC: BOSCH® CX
RANGE: 32T-38T
COLOR: As Order
OPTION: Spacer thickness



CH-BOSCX-MED2 CH-BOSCX-MED CH-BOSCX-MINI

CH-R1-MINI

2027.P47-01

Design for mtb 1x system drivetrain.

Carbon long fibers with nylon Injection.

Without ADP-N.

Easy to set up the top guide position.

MATERIAL: Carbon with nylon

SPEC: ISCG-05

RANGE: 30T - 36T

WEIGHT: 28g/set



NEW **CH-FD-SH-MED2**

2027.P51-02

Upper guide for single speed FD mount system frame .

MATERIAL:AL6061-T6 arm/nylon cage

SPEC:FD mount system

RANGE:42T-68T

COLOR: AS ORDER

WEIGHT:30g



NEW **CH-FD-SHF**

2027.P51-03

Inner guide for single speed FD mount system frame .

MATERIAL:AL6061T6 arm/nylon cage

SPEC:FD mount system

RANGE:42T-68T

COLOR: AS ORDER

WEIGHT:20g



CH-EX-FD

2027.P51-04

Low-profile, FD mount chain guard for 1X drivetrains.

Alloy body, with a nylon guide that is easy to adjust
and quiet on your chain.

MATERIAL: AL6066-T651 body / nylon cage

SPEC: FD mount system

RANGE: 32T - 58T

COLOR: Black

WEIGHT: 25g/set



CH-ES-LD

2027.P47-05

Low-profile, low direct mount chain guard for 1X drivetrains.

Carbon injection body, with a nylon guide that is easy to
adjust and quiet on your chain.

MATERIAL: Carbon body / nylon cage

SPEC: Low direct mount system

RANGE: 32T - 36T

COLOR: Black

WEIGHT: 17g/set



CH-CM1

2027.P52-03

Chain guard for 1 by 9, 10, 11 speed.

With plastic upper guard.

MATERIAL: AL6061-T6

DIA: Ø34.9 With adapter to Ø31.8

COLOR: Black



NEW

ADP-KIOX-INT200

2027.P77-01

Compatible with KIOX Intuvia 200 display,
Allows angle and side adjustment for clear rider
display visibility.

MATERIAL: Nylon
SPEC: For Ø31.8mm handlebar



ADP-KIOX-GR-MB-32 / 35

2027.P78-04

Clamp type computer mount for KIOX on-board computer.

MATERIAL: Nylon
SPEC: For Ø31.8mm / Ø35mm handlebar



Ø31.8
or
Ø35

ADP-KIOX-FBE-32 / 35

2027.P77-02

For new generation KIOX bracket.
Install KIOX display in front of the stem position.

MATERIAL: Nylon
SPEC: For Ø31.8mm / Ø35mm handlebar



ADP-KIOX-MBE32 / 35

2027.P77-04

For new generation KIOX bracket.
Install KIOX display rear and left of the handlebar position.

MATERIAL: Nylon
SPEC: For Ø31.8mm / Ø35mm handlebar



ADP-KIOX-FBE-BAR-32 / 35

2027.P78-02

For new generation KIOX bracket include
extension bar for control unit.

MATERIAL: Nylon
SPEC: For Ø31.8mm / Ø35mm handlebar



22.2mm

ADP-KIOX-GRBAR-32 / 35

2027.P78-02

ADP-KIOX-GR-32 / 35

2027.P78-01

Clamp type computer mount for
KIOX on-board computer.

MATERIAL: Nylon
SPEC: For Ø31.8mm /
Ø35mm handlebar



Ø31.8
or
Ø35

22.2mm

ADP-KIOX-BWP

2027.P78-05

Clamp type computer mount for Kiox
on-board computer.
For MTB bike.

MATERIAL: Nylon
SPEC: For Ø31.8mm handlebar clamp



Ø31.8

ADP-KIOX-TOP

2027.P78-03

Top cap type computer mount.
For Kiox.

MATERIAL: Nylon
SPEC: For Ø28.6mm steerer tube



37

ADP-KIOX-FP

2027.P78-06

Clamp type computer mount for Kiox
on-board computer.
For Road bike / City bike.

MATERIAL: Nylon
SPEC: For Ø31.8mm handlebar clamp



Ø31.8

NEW

CX-DA12S/CX-UT12S/CX-10512S

2027.P44-01

Narrow wide chainring for SHIMANO® 12 speed crank. With mud remove design on teeth shape.

Fix SHIMANO® crankset with special bolt.

MATERIAL: AL7075-T651 full CNC made

P.C.D: Ø110mm

TEETH SPEC: 56T/58T/60T/62T/64T/66T

CRANK COVER CAP MATERIAL AL7075-T651

CHAINRING BOLT MATERIAL AL7075-T651

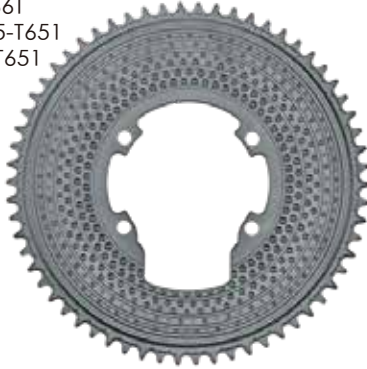

Option



CX-DA12S For SHIMANO® FC-R9200 crank
CX-UT12S For SHIMANO® FC-R8100 crank
CX-10512S For SHIMANO® FC-R7100 crank

NEW

CX-XTR12S-DI2

2027.P43-01

Narrow wide chainring for new XTR/XT DI2 12speed direct mount crank.

MATERIAL: AL7075-T651

TEETH: 30T/32T/34T/36T/38T/40T/42T

SPEC: XTR/XT DI2 12speed

COLOR: As order

WEIGHT: 70G(36T)



NEW

CX-G12S

2027.NEW

Narrow wide chainring for SHIMANO GRX. With mud remove design on teeth shape.

MATERIAL: AL7075-T651 full CNC made

P.C.D: Ø110mm

TEETH: 40T/42T/44T



CX-CR-L

2027.P44-02

MATERIAL: CR-MO steel heat treatment

TEETH SPEC: 25T / 28T / 30T

HIGHT: 3mm

COLOR: ED BK



CX-E-MOTO

2027.P44-03

E motor chainring with mud remove design on teeth shape.

FIT: 420 chain

MATERIAL: AL7075-T651

P.C.D: Ø68.5 Hole

TEETH: 58T / 60T / 62T / 64T

COLOR: As Order

Custom design available



CX-XTR-DIR

2027.P43-03

Narrow Wide chainring for XTR / XT 12 speed crank.

MATERIAL: AL7075-T651

TEETH: 30T / 32T / 34T / 36T

SPEC: XTR/XT Direct mount



CX-TD-DIR

2027.P43-02

Narrow wide chainring for SRAM® T type crank.

MATERIAL: AL7075-T651

TEETH: 30T / 32T / 34T / 36T

SPEC: SRAM® T type direct mount 8-bolt

OFFSET: 3mm for chainline 55mm



Property	Specification
----------	---------------

Remanence	>1.3T
Polarization	Towards Sensor
Dimensions	Thickness > 0.5 x Diameter (h > 0.5d) Diameter > Thickness(d > h)
Volume*	$V = \pi \times h \times (d / 2)^2$ Depending

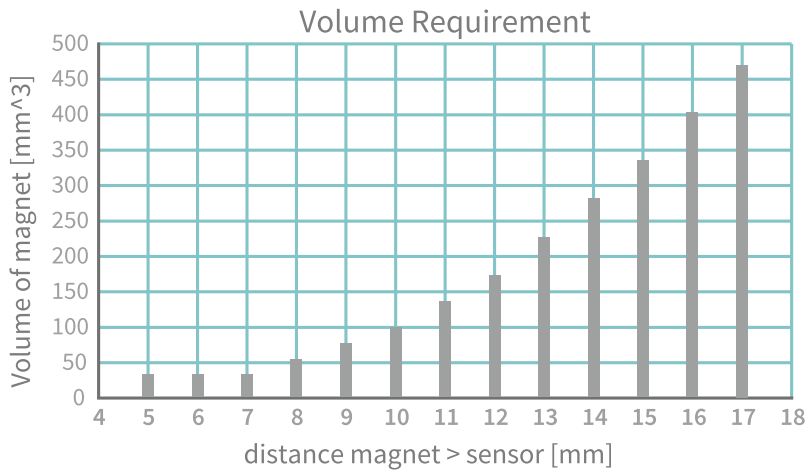
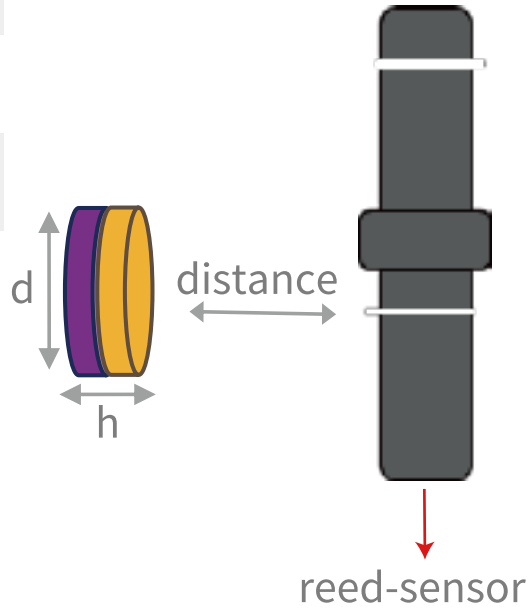

► **6-Bolt Magnet**

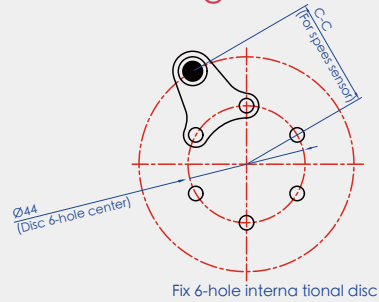

ADP-SHE8-1S



ADP-SHE8-2S



ADP-SHE8-3S



ADP-SHE8-W60S

► **5-Bolt Magnet**

Fix SM-RTC60

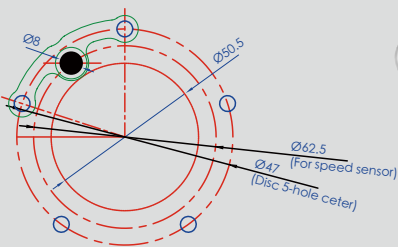

ADP-SHE8-P74S

SHIMANO® SM-RTC60:
5-hole disc with 74mm pitch circle diameter.
SHIMANO® SG-C6061-8CD:
5-hole disc with 74mm pitch circle diameter.

► **Center Lock Magnet**

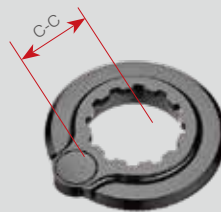

ADP-SHE8-MSH44-19

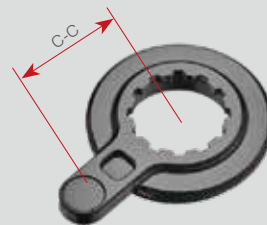

ADP-SHE8-MSH44-32

► **Center Lock Magnet**

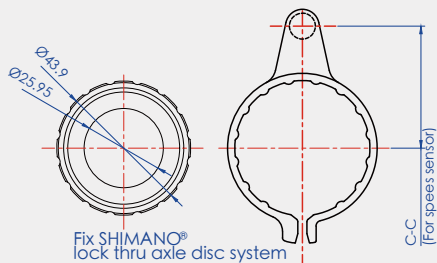

Fix SHIMANO® lock thru axle disc system

ADP-M-SHE8-32CS



ADP-M-SHE8-40CS



ADP-SHE8-P74S

2027.P85-01

For E-bike speed sensor adapter, can fix SHIMANO® SM-RTC60.

MATERIAL: Stainless washer with N45 SH magnet
SPEC: C-C 40mm



ADP-SHE8-1S

ADP-SHE8-2S

ADP-SHE8-3S

ADP-SHE8-W56S/ADP-SHE8-W60S

2027.P85-02

For E-bike speed sensor adapter.

MATERIAL: Stainless washer with N45 SH magnet

SPEC: ADP-SHE8-1S: C-C 32mm with 1mm magnet
ADP-SHE8-2S: C-C 32mm with 2mm magnet
ADP-SHE8-3S: C-C 40mm with 2mm magnet
ADP-SHE8-W56S: C-C 56mm with 2mm magnet
ADP-SHE8-W60S: C-C 60mm with 2mm magnet



ADP-SHE8-WS

2027.P86-01

Washer of SHIMANO® disc rotor.

MATERIAL: Stainless steel
THICKNESS: 0.5mm



ADP-SHE8-HS

2027.P86-02

For E-bike speed sensor adapter.

MATERIAL: Stainless washer with N45 SH magnet
SPEC: C-C 32mm with 1mm magnet



ADP-M-SHE8-32CS ADP-M-SHE8-40CS

2027.P86-03

Lockring adapter for E-bike speed sensor.

MATERIAL: AL6061 washer with N45 SH magnet

SPEC:
ADP-M-SHE8-1: C-C 32mm with 2mm magnet
ADP-M-SHE8-2: C-C 40mm with 2mm magnet



NEW

ADP SHE8-MSH44-19

ADP SHE8-MSH44-32

2027.P86-07

Center lock with integrated N45 SH magnet for E-BIKE speed sensor .

MATERIAL: AL6061-T6 /N45 SH magnet Center lock OD/44MM

SPEC:
ADP SHE8-MSH44-19: C-C 19mm with 3mm magnet
ADP SHE8-MSH44-32: C-C 32mm with 3mm magnet

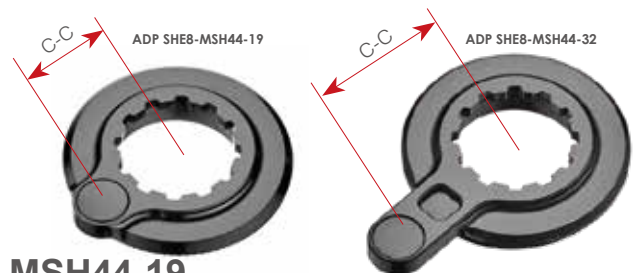

ADP-SH2

2027.P86-04

SHIMANO® center-lock disc hub adapter.
Stainless steel washer with alloy nut



ADP-SH1

2027.P86-05

SHIMANO® center-lock disc hub adapter.
Stainless steel washer with alloy nut



ADP-SH1220

2027.P86-06

SHIMANO® center-lock 12 / 20mm thru-axle disc hub adapter.
With alloy locking (M-SH3611)

OPTION: Cr-Mo lock ring (M-SH1521-CR)



ADP-DISC-SH-F

2027.P86-08

Center lock system / With alloy locking.
Front 15mm boost hub adapter for 100mm transform to 110mm hub.



ADP-DISC-SH-R

2027.P86-09

Center lock system / With alloy locking.
Rear 12mm boost hub adapter for 142mm transform to 148mm hub.



ADP-DISC-F

2027.P86-11

Front 15mm boost hub adapter for 100mm transform to 110mm hub.



ADP-DISC-R6

2027.P86-10

Rear 12mm boost hub adapter for 142mm transform to 148mm hub.





P.A.T.E.D. WORLD WIDE



PATENTED

CL-CV OVER SIZE

2027.P17-01

SPEC: Ø27.2 seatpost - Ø31.8 seattube / Ø31.6 seatpost - Ø34.9 seattube
 Ø27.2 seatpost - Ø34.9 seattube / Ø30.9 seatpost - Ø34.9 seattube
 Ø33.9 seatpost - Ø38.1 seattube / Ø34.9 seatpost - Ø38.6 seattube

TK-MG-CO

2027.P26-01

Top cap with full cover.

Material: AL-6061T6

COLOR: As order

WEIGHT: 9g

Custom logo design available



TK-001S

TK-001S-38.1

2027.P27-01

MATERIAL: AL6061-T6

WEIGHT: 17.5g/pcs (W/O star nut)

SIZE: 1" , 1-1/8" or 1-1/2"

OPTION: 1. Stainless screw
 2. Star nut



NEW

STAR NUT-030

2027.P27-11

For internal routing of front brake hose and front electrical cable.

SPEC: 1-1/8 steere tube.

WEIGHT:9.5g



TK-BEERA

2027.P27-02

With TK-001S

Material: AL6061-T6 CNC finished

COLOR: As order

WEIGHT: 23g (W/O star nut)

Size: 1-1/8"



TK-TD-C

2027.P27-03

MATERIAL: Carbon

WEIGHT: 11.5g/pcs (W/O star nut)

SIZE: 1-1/8"

With star nut



TK-TD18

BEST SELLER

2027.P27-04

MATERIAL: AL6061-T6

WEIGHT: 13.3g/pcs (W/O star nut)

SIZE: 1-1/8"

COLOR: Sandblasting anodize with star nut

OPTION: AL7075-T73 screw

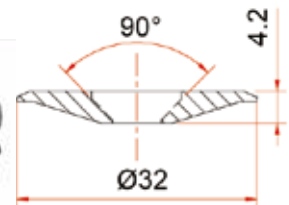

TK-TD12-E

2027.P27-05

MATERIAL: AL6061-T6

WEIGHT: 16.5g/pcs (W/O star nut)

SIZE: 1-1/8"

COLOR: Sandblasting anodize

Stainless screw

OPTION: AL7075-T73 screw

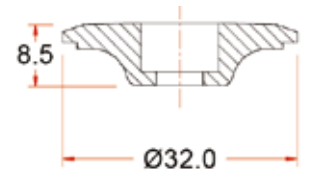

TK-TD01

2027.P27-06

MATERIAL: AL6061-T6

WEIGHT: 13g/pcs (W/O star nut)

SIZE: 1-1/8"

COLOR: Sandblasting anodize with star nut

OPTION: AL7075-T73 screw

Stainless screw

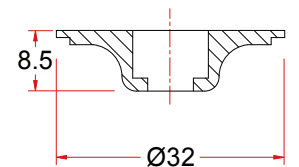

TK-001D

2027.P27-08

MATERIAL: AL6061-T6

WEIGHT: 14.5g/pcs (W/O star nut)

SIZE: 1" , 1-1/8"

OPTION: 1. Stainless screw

2. Star nut



AC-25.4-H / AC-28.6-H
AC-31.8-H / AC-38.1-H



2027.P30-04

Carbon spacer.

Spec: AC-25.4-H (ID $\varnothing 25.6 \pm 0.2$ x OD $\varnothing 31.5$)
AC-28.6-H (ID $\varnothing 28.8 \pm 0.2$ x OD $\varnothing 34$)
AC-31.8-H (ID $\varnothing 32.0 \pm 0.2$ x OD $\varnothing 38.8$)
AC-38.1-H (ID $\varnothing 38.3 \pm 0.2$ x OD $\varnothing 45.2$)

H: As Order
Color: 3K, UD



ACE-28.6-H
ACE-31.8-H

2027.P31-02

Carbon spacer.

P.A.T ED

Spec: ACE-28.6-H (ID $\varnothing 28.8$ x OD $\varnothing 34$)
ACE-31.8-H (ID $\varnothing 32.0$ x OD $\varnothing 38.8$)

H: As Order
Color: 3K, UD



AR-25.4-H / AR-28.6-H
AR-31.8-H / AR-38.1-H



2027.P30-02

Alloy spacer.

Spec: AR-25.4-H (ID $\varnothing 25.6 \pm 0.2$ x OD $\varnothing 32$)
AR-28.6-H (ID $\varnothing 28.8 \pm 0.2$ x OD $\varnothing 32.5$,
 $\varnothing 33$, $\varnothing 34$, $\varnothing 35$, $\varnothing 36$)
AR-31.8-H (ID $\varnothing 32.0 \pm 0.2$ x OD $\varnothing 38.8$)
AR-38.1-H (ID $\varnothing 38.3 \pm 0.2$ x OD $\varnothing 44$)

H: As Order
Color: As Order



AE-28.6-H



2027.P30-01

Alloy spacer.

P.A.T ED

Spec: AE-28.6-H (ID $\varnothing 28.8 \pm 0.2$ x OD $\varnothing 34$)

H: As Order
Color: As Order



AR-28.6-H

2027.P31-01

Alloy spacer for Ø28.6 fork.

Carbon fiber steering tube please notify.

MATERIAL: AL6061-T6

SPEC: ID 28.6+0.1+0.4 x OD Ø34mm

ID 28.6+0.1+0.4 x OD Ø36mm

H: OD Ø34/ 50, 100, 110, 120, 130, 140, 150, 160, 180, 200 mm

OD Ø36/ 50, 100, 110, 120, 130, 140, 150, 170, 200 mm

COLOR: Sand blast black, silver, Black, Silver, As Order



SHIM -1012

BEST SELLER

2027.P60-01

MATERIAL: AL6061-T6

SPEC: OD Ø30.0 x ID Ø27.2 x (H) 100mm

OD Ø30.2 x ID Ø27.2 x (H) 100mm

OD Ø30.6 x ID Ø27.2 x (H) 100mm

OD Ø30.9 x ID Ø27.2 x (H) 100mm

OD Ø31.6 x ID Ø27.2 x (H) 100mm

OD Ø33.9 x ID Ø30.9 x (H) 110mm

OD Ø34.9 x ID Ø30.9 x (H) 110mm

OD Ø33.9 x ID Ø31.6 x (H) 110mm

OD Ø34.9 x ID Ø31.6 x (H) 110mm

OD Ø40.0 x ID Ø33.9 x (H) 120mm

OD Ø40.0 x ID Ø34.9 x (H) 120mm

COLOR: As Order

Customized service design available.



ADP-STEM

2027.P29-02

Steering tube extend.

For Ø28.6mm fork.

MATERIAL: AL6061-T6

LENGTH: 50mm, 90mm, 120mm

With top cap & long screw x2pcs
for custom to assemble

Adjust the height (mm)

	MIN	MAX
50	47.5	65.5
90	47.5	105.5
120	47.5	135.5





NEW DROPPER POST

NEW SPA-DP

2027.P58-01

Lightweight design and precision manufacturing.
More drop options available

Diameter: 30.9 or 31.6
Drop options: 100/125/150/175/200mm
WEIGHT: 482g (OD 31.6 / 100mm)
Internal cable routing.



DROPPER LEVER



SIZE

- 30.9 or 31.6 x T100
- 30.9 or 31.6 x T125
- 30.9 or 31.6 x T150
- 30.9 or 31.6 x T175
- 30.9 or 31.6 x T200



NEW SPA-SDP

2027.P58-02

Simplify design and precision manufacturing. Adjustable seat height.

MATERIAL: AL6061-T6/AL7075-T651
Diameter: 30.9 or 31.6
Drop: 150mm
OFFSET: 18mm
WEIGHT: 605.5g



SPA-35A

2027.P59-01

MATERIAL: 3D forged AL6061-T6
SPEC: $\varnothing 31.8$ or $\varnothing 34.9\text{mm}$
LENGTH: 450mm/ 600mm/ 700mm
OFFSET: 20mm
WEIGHT: 626g ($\varnothing 34.9 \times 450\text{mm}$)



NEW

SPA-SL7

2027.P59-02

Aluminum tube with cold drawn process, easy of adjustment and lightweight and stiffness.

MATERIAL: AL7075-T73
Size : $\varnothing 34 \times 630\text{L}$
OFFSET: 0mm
WEIGHT: 395g
COLOR: Sand blast anodize



NEW

SPA-SF1

2027.P59-03

Lightweight Aluminum Tube.

MATERIAL: Clamp base: Steel
Tube: AL6061-T6 PG

SPEC: $\varnothing 31.8 \times 610\text{L}$
THICKNESSES: 2.5T
WEIGHT: 605g
COLOR: Clamp base: ED/Black
Tube: Sand blast anodized



NZ-TUSH-F

2027.P91-02

The multi-vent valve allows users to pump up tyres quickly and also works with most the foam-inserted tubeless tyres.

MATERIAL: AL6061-T6 with NBR taper cone spacer
SPEC: Presta valve
LENGTH: 47, 52, 62, 72, 87, 107mm



NEW

SSP-SREICO-1218

2027.P39-01

12T/18T Carbon pulley with carbon/alloy cage for SRAM® AXS RED E1/FORCE E1.

MATERIAL: Carbon/Alloy Cage/Carbon pulley
SPEC: 12T+18T
FOR: SRAM® AXS RED E1/FORCE E1.
COLOR: UD Carbon
OPTION: Ceramics ball bearing



NEW

SSP-SR71CO-1218

2027.P39-02

12T/18T Carbon pulley with carbon/alloy cage for RD-R7150 12S (105 DI2)/RD R7100 12S.

MATERIAL: Carbon/Alloy Cage/Carbon fiber pulley
SPEC: 12T+18T
FOR: SHIMANO® R7150 12S (105 DI2)/RD R7100 12S
COLOR: UD Carbon
OPTION: Ceramics ball bearing



NEW

SSP-SR71A-1218

2027.P39-03

12T/18T AL7075-T651 Pulley with carbon 3k cage for RD-R7150 12S (105 DI2)/RD R7100 12S.

MATERIAL: Carbon 3k Cage/AL7075-T651 Pulley
SPEC: 12T+18T
FOR: SHIMANO® R7150 12S (105 DI2)/RD R7100 12S
COLOR: 3K Carbon
OPTION: Ceramics ball bearing.



NEW

SSP-SR98A-1218

2027.P39-04

12T/18T AL7075-T651 Pulley with carbon cage for RD-R9250 12S (DURA-ACE DI2)/RD-R8150 12S (ULTEGRA DI2).

MATERIAL: Carbon Cage/AL7075-T651 Pulley
SPEC: 12T+18T
FOR: SHIMANO® RD-R9250 12S (DURA-ACE DI2)/RD-R8150 12S (ULTEGRA DI2)
COLOR: 3K Carbon



NEW

SSP-SR71N-1218

2027.P39-05

12T/18T Carbon pulley with carbon 3k cage for RD-R7150 12S (105 DI2)/RD R7100 12S.

MATERIAL: Carbon 3k Cage/Carbon pulley
SPEC: 12T+18T
FOR: SHIMANO® R7150 12S (105 DI2)/RD R7100 12S
COLOR: 3K Carbon
OPTION: Ceramics ball bearing.



NEW

SSP-SR98N-1218

2027.P39-06

12T/18T Carbon pulley with carbon cage for RD-R9250 12S (DURA-ACE DI2)/RD-R8150 12S (ULTEGRA DI2) .

MATERIAL: Carbon Cage/Carbon pulley
SPEC: 12T+18T
FOR: SHIMANO® RD-R9250 12S (DURA-ACE DI2)/RD-R8150 12S (ULTEGRA DI2)
COLOR: 3K Carbon
OPTION: Ceramics ball bearing.



NEW

SSP-SRE1A-1218

2027.P40-01

12T/18T AL7075-T651 pulley with carbon 3K cage for SRAM® AXS RED E1/FORCE E1.

MATERIAL: Carbon 3K Cage/AL7075-T651 Pulley
SPEC: 12T+18T
FOR: SRAM® AXS RED E1/FORCE E1.
COLOR: 3K Carbon
OPTION: Ceramics ball bearing.



NEW

SSP-SRE1N-1218

2027.P40-02

12T/18T carbon with carbon cage for SRAM® AXS RED E1/FORCE E1.

MATERIAL: Carbon Cage/Carbon pulley
SPEC: 12T+18T
FOR: SRAM® AXS RED E1/FORCE E1.
COLOR: 3K Carbon
OPTION: Ceramics ball bearing.



NEW

SSP-AXCO-ROLLER KIT

2027.P40-03

Upper 12T/Lower 16T derailleur cage for SRAM® RED AXS/FORCE/RIVAL 12 speed system.

MATERIAL: Carbon Cage/AL7075-T651 PULLEY

SPEC:

SRAM® RED AXS / FORCE / RIVAL derailleur SYSTEM.

COLOR: 3K Carbon

WEIGHT: 58g



SSP-AX-ROLLER KIT

2027.P40-04

MATERIAL: AL6061-T6 Cage

AL7075-T651 Pulley

SPEC: SRAM® AXS derailleur system

COLOR: As Order

WEIGHT: 67g/set

OPTION: Ceramics ball bearing



SSP-R91-CO ROLLER KIT

2027.P40-05

Oversize derailleur cage with 12T upper and 16T lower pulley. With carbon plate. Pulley are full CNC made from AL7075-T651 with Cr-Mo or steel bearing. Compatible with SHIMANO® RD 9150 / RD 8050 / RD 9100SS.

MATERIAL: Carbon Cage & AL7075-T651 Pulley

SPEC: Fit SHIMANO® RD 8050 / RD 9150 / RD 9100SS

COLOR: As Order

OPTION: Ceramics ball bearing

Not available in Japan



SSP-R8050 ROLLER KIT

2027.P40-06

Oversize derailleur cage with 12T upper and 16T lower pulley. Pulley are full CNC made from AL7075-T651 with Cr-Mo or steel bearing. Compatible with SHIMANO® RD 8050 / RD 8000.

MATERIAL: AL6061-T6 Cage

AL7075-T651 Pulley

SPEC: Fit SHIMANO® RD 8050 / RD 8000

COLOR: As Order

OPTION: Ceramics ball bearing

Not available in Japan



NEW ADP-GR-LHSOS 2027.P98-01

Light holder with intergrated tubeless repair kit.

Material: AL6061-T6
TUBELESS REPAIR KIT CONTENT
Reamer/Pluggger/Tire seal strip
COLOR: AS ORDER
WEIGHT:45g

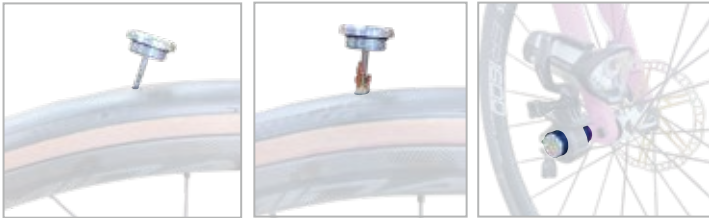

NEW ADP-GR-LHTL 2027.P98-02

Light holder with intergrated tool bits.

MATERIAL:AL6061-T6
3PCS BITS CONTENT
HEX 5MM/4MM/T25
COLOR: AS ORDER
WEIGHT: 60g



NEW ADP-GR-LH 2027.P98-03

Light holder for gravel bike to mount on the fork or thru axle with M5 thread.

MATERIAL: AL6061-T6
COLOR : AS ORDER
WEIGHT: 24g

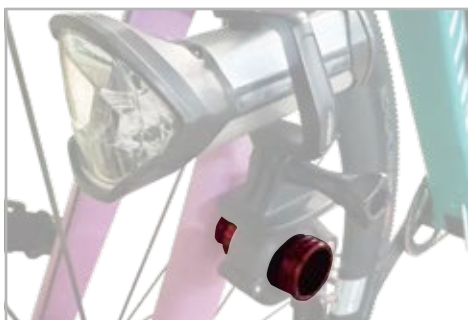

NEW ADP-3RL-2X32 2027.P75-03

Double clamp for Ø31.8 extension bar, create extra space for bikepacking gear.

Material: AL6061-T6
Spec: Clamp Ø31.8mm
TUBE: Ø31.8 x 200L



Removeable end cap.
Tube inside for extrastorage space.

ADP-3RL

2027.P76-03

Double alloy clamp with length 200mm tube.
Adjustable clamp spacing.

MATERIAL: AL6061-T6
SPEC: Ø31.8mm
TUBE LENGTH: 200L
WEIGHT: 43g/ set
COLOR: As Order



NEW

ADP-ORG32-SSM

2027.P76-04

Create extra space for handlebar. Integrated computer mount and light. Adequate lighting. Angle adjustable. Best provide for heat dissipation. (Light not included.)

MATERIAL: AL6061-T6
SPEC: Ø31.8mm
W: 58mm
WEIGHT: 100g
Light holder compatible with SUPERNOVA® Starstream mini



ADP-ORG26

2027.P76-05

Create extra space for handlebar.
Double clamp with tube Ø26mm

Material: AL6061-T6 clamp
ADP-ORG26: 3K CARBON tube
ADP-ORG26-A: AL6061-T6 tube
SPEC: Ø31.8mm
W: 46mm / 59mm



ADP-ORG26-35 ADP-ORG26-35-A

2027.P76-07

Create extra space for handlebar.
Double clamp with tube Ø26mm

MATERIAL: AL6061-T6 clamp
ADP-ORG26-35: 3K CARBON tube
ADP-ORG26-35-A: AL6061-T6 tube
SPEC: Ø35mm
W: 46mm / 59mm

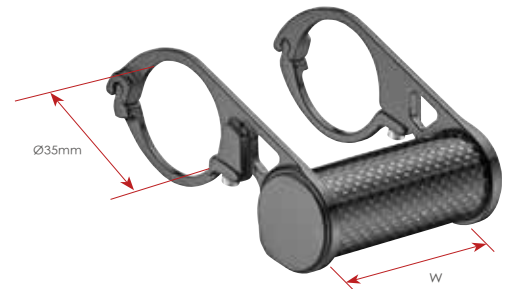

ADP-BCM-P

2027.P72-04

For handlebar cycling computer mount.
With removable GoPro® interface.
Simple and fast installation.
CNC bracket, available in interchangeable trays.
Compatible with Garmin Edge 1050.

MATERIAL: AL6061-T6
SPEC: Clamp Ø31.8mm
WEIGHT: 57g/set



AC-MTB35

2027.P72-03

Clamping type for MTB and cyclocross cycling computer mount.
Allow riders place computer above the stem.

MATERIAL: AL6061
SPEC: Clamp Ø35mm with SHIM Ø31.8mm
WEIGHT: 39g/ set



NEW COMPUTER MOUNT



Angle adjust serew.



Secondary fixing screw.

P.A.T.
Taiwan No.113206040 / 113206042
China No.202421339745.6 / 202421339739.0



GM-GRA

2027.P71-02

Computer mount for integrated bar stem.
Main arm angle adjustable.
Compatible with Garmin Edge 1050.

MATERIAL: AL 6061-T6
Extension arm / PA66
FEATURES: Extension arm angle adjustable.
Dual fixing bolt system.
Interchangeable tray system.



GM-GR-CX2

2027.P71-03

CNC bracket available in interchangeable trays.
Fit stem screw distance : 25mm- 34mm
Compatible with Garmin Edge 1050.

MATERIAL: Base / AL6061-T6
Extension arm / PA66
FEATURES: Extension arm angle adjustable.
Dual fixing bolt system.
Interchangeable tray system.

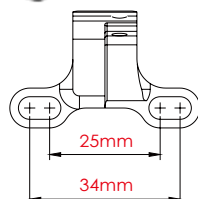

Fit stem screw distanc



GR-MOUNT-AEROLIGHT

2027.P72-01

Best computer mount solution when use areo handlebar with barbore Ø31.8 stem.
Cap fit Giant® CONTACT AEROLIGHT STEM.
Compatible with Garmin Edge 1050.

MATERIAL: Cap / AL-6061-T6
Extension arm / PA66
FEATURES: Extension arm angle adjustable.
Dual fixing bolt system.
Interchangeable tray system.

Stem cap customsize available.

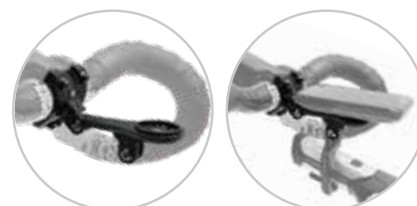

GR-MOUNT-SL-R

2027.P71-04

Best computer mount solution when use areo handlebar with barbore Ø31.8 stem.
Cap fit Giant® CONTACT SL AERO STEM and CONTACT SLR AERO STEM.
Compatible with Garmin Edge 1050.

MATERIAL: Cap / AL-6061-T6
Extension arm / PA66
FEATURES: Extension arm angle adjustable.
Dual fixing bolt system.
Interchangeable tray system.

Stem cap customsize available.



AVAILABLE IN DIFFERENT CYCLING COMPUTER AND CAMERA / LIGHT MOUNT

Interchangeable trays:



GM1
(GARMIN® Edge)



Mio2
(MIO® Cyclo™)



BTN3
(Bryton® Rider™)



GAT5
(GIANT® NEOSTRACK)

NEW



WHO6
(WAHOO® ELEMNT)



HMD8
(HAMMERHEAD KAROO®)



GPO7
(GoPro®)



NEW

AR-ADJ-GM1

2027.P71-01

Angle adjustable design.
5mm spacer style computer mount.
Fits 1-1/8" steerer tube.

Base / Extension arm
MATERIAL: AL6061-T6
Tray
MATERIAL: Nylon



WB-EXT-M

2027.P80-03

Bottle cage adapter.
Used to change the position of the water bottle cage.
Adjustable range 46mm.
MATERIAL: AL6061-T6

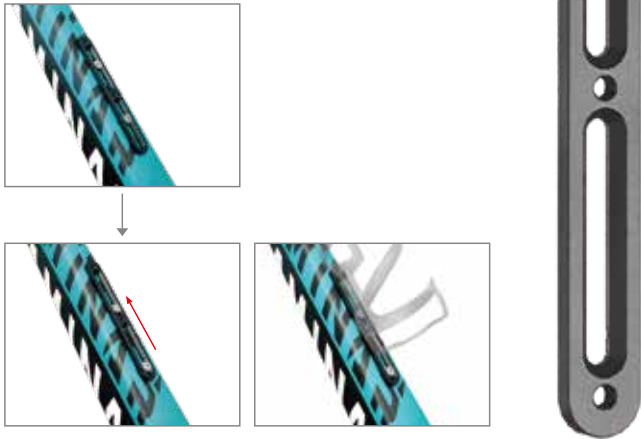

CL-ST22/CL-ST24

2027.P87-12

Clamp for ROAD bike lever.

MATERIAL: stainless
SPEC: CL-ST22: Ø22.2 × 12.5L, M5
CL-ST24: Ø24 × 14.9L, M6



WB-STP52

2027.P80-01

Excellent solution for extra parts storage.

MATERIAL: Bracket/ AL6061-T6
Strap/ Plastic+ Velcro
SPEC: Strap/ 25 x 250mm



AR-STP34

2027.P80-02

Extra storage spacer in stem area.

MATERIAL: Spacer/ AL6061-T6
Strap/ Plastic+ Velcro
SPEC: Spacer/ H 4mm, ID Ø28.6mm
Strap/ 25 x 250mm

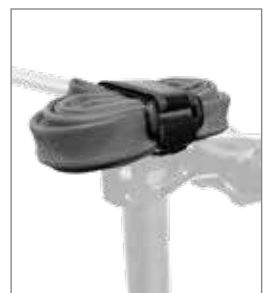

WB-R1-20C WB-R1-20C-L

2027.P79-01

The unique geometric-design water bottle cage, made of high-strength carbon-compound fiber, gives rooms to quick-link storage, and secures the water bottle firmly while in motion. This side-pull water bottle cage allows bikers to retrieve water bottles sideward or upward.

SPEC:
WB-R1-20 for right side to access water bottle.
WB-R1-20-L for left side to access water bottle.
MATERIAL: Carbon compostie
WEIGHT: 32g/pcs



Extra space for quick-link.

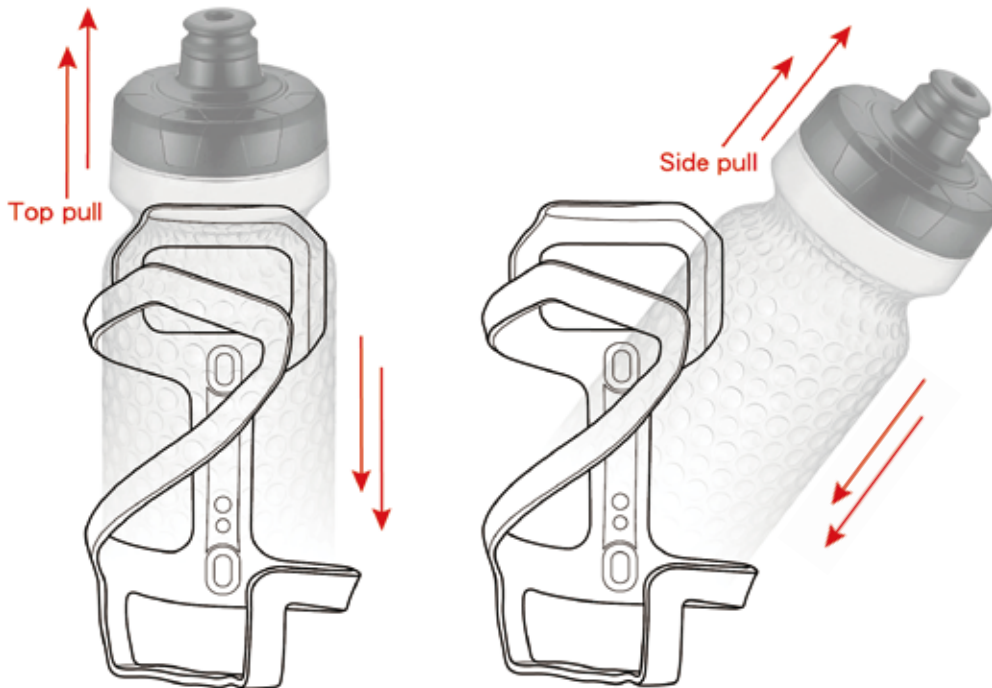

Easy to access bottle sideward or upward.



WE CAN REACH YOUR IDEAL DESIGN BASED ON OUR STEM EXTRUSION MATERIAL DATA.

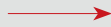
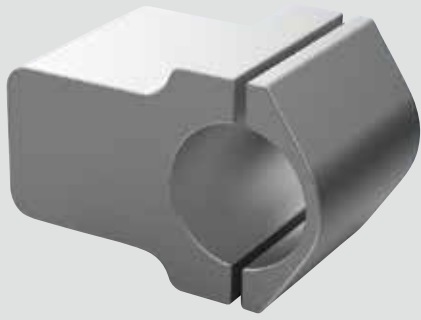

WE MAKE STEM(CNC)



NEW STEM-KIX

2027.P62-01

Intergrate with BOSCH® KIOX BES3 monitor.
Compatible with TOKEN® C-BOX integrated cable headset system.
Include TOP-CAP and KIOX adaptor.

Material: Alloy
Angle: +12°
Length:90/110mm



NEW STEM-KIX-LT

2027.P62-02

Intergrate with BOSCH® KIOX BES3 monitor. Compatible with TOKEN® C-BOX integrated cable headset system. Include TOP-CAP, monitor adaptor, and front light adaptor. (Light not include.)

Material: Alloy
Angle: +12°
Length:90/110mm



Front light adapter.
Compatible with
SUPERNOVA®
starstream series

TL-BB-EXT56
TL-BB-EXT50
TL-BB-EXT48
TL-BB-EXT43

2027.P82-01

The BOTTOM BRACKET TOOL is made by high precision CNC machine to provide better contact area and stability of operation. It can suitable for different specifications of BB and prevent tool slippage during use.

MATERIAL: AL 7075 - T651
 WEIGH T: **EXT56** 109g / **EXT50** 91g / **EXT48** 82g / **EXT43** 66g
 COLOR: **EXT56** Silver / **EXT50** Gold / **EXT48** Green / **EXT43** Gray

TL-BB-EXT56



TL-BB-EXT48



TL-BB-EXT50



TL-BB-EXT43



TL-BB-AXLE 2224
TL-BB-AXLE 2829
TL-BB-AXLE 2830

2027.P82-02

Suitable for different specifications of BB and prevent tool slippage during use.

MATERIAL: AL 6061-T6
 WEIGH T: **AXLE2224** 59g / **AXLE2829** 117g / **AXLE2830** 125g
 COLOR: **AXLE2224** Blue / **AXLE2829** Black / **AXLE2830** Red



TL-BB-AXLE 2224



TL-BB-AXLE 2829



TL-BB-AXLE 2830

TL-BB-SET

2027.P82-03

Both sides of the tool are available to BB of different sizes, and the different colors make it easy to distinguish the sizes.

MATERIAL: AL 7075-T651 / AL 6061-T6
 SPEC: Bottom bracket tool & Axle



TL-BB-EXT56



TL-BB-EXT48



TL-BB-EXT50



TL-BB-EXT43



TL-BB-AXLE 2224



TL-BB-AXLE 2829



TL-BB-AXLE 2830



TK-ATG01

2027.P101-02

Top cap with Air Tag holder, special locking tool include.

MATERIAL: Top cap: AL6061

Tool: Nylon

WEIGHT: 28g/ set

Air Tag not included



WB-ATG-02

2027.P101-03

Air Tag holder that mount on the bike frame water bottle attachment point, and zip tip under the bike saddle rail.

MATERIAL: Nylon66

COLOR: Black

WEIGHT: 23g/pcs (With bolt)

Air Tag not included



PU-8703-T22

2027.P81-06

The function of protector is to provide the best Friction resistance and protection for the frame, it keeps your frame new and clean.

MATERIAL: PVC

Spec: Top tube protection x1

Down tube protection x1

Chainstay protection x2

Frame or other protection x6

H: 0.4mm

COLOR: 50% transparent

WEIGHT: 31g

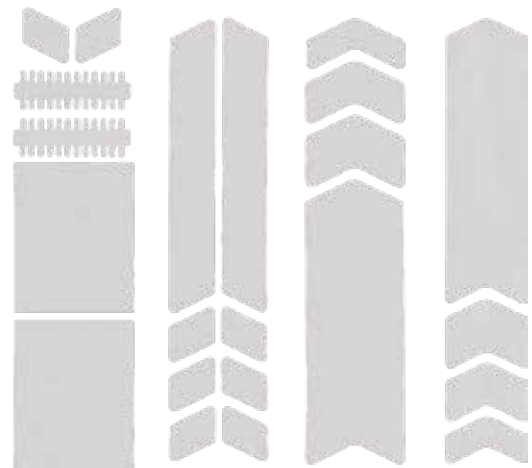

PU-9000-T22

2027.P81-07

The function of protector is to provide the best Friction resistance and protection for the frame, it keeps your frame new and clean.

MATERIAL: PU

Spec: Top tube protection x1

Down tube protection x1

Chainstay protection x2

Frame or other protection x6

H: 0.25mm

COLOR: Transparent

WEIGHT: 29g

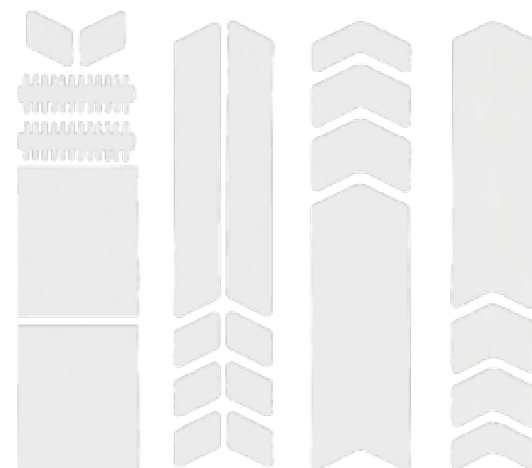

ANTI NUT CO -L(AM)

2027.P101-06

MATERIAL: STEEL NUT /AL6061T6 CONE
SPEC: M9*1.0,M10*1.0,3/8*26T
LENGTH: 30MM
With SPECIAL ALLEN KEY



ANTI NUT CO -LOE(OE)

2027.P101-07

MATERIAL: STEEL
SPEC: M9*1.0,M10*1.0,3/8*26T
LENGTH: 23MM/28MM
With SPECIAL ALLEN KEY



RS-MINI BAR-02

2027.P94-06

New design can combination with lock-on grip.

MATERIAL: Nylon
WEIGHT: 30.4g/set



RS-MINI BAR

2027.P94-05

Create an additional hand position on the handlebar.
Minimizes hand numbness, carpal and ulnar issues.

MATERIAL: Nylon
SPEC: ID Ø22.2mm
WEIGHT: 17.8g/set



ADP-FA-P16

2027.P90-01

For flat mount fork adapter to post mount caliper.

MATERIAL: AL 6061-T6
Spec: For 160m/m rotor
WEIGHT: 42g/pcs



ADP-RFA-P14

2027.P90-05

For flat mount frame adapter to post mount caliper.

MATERIAL: AL 6061-T6
Spec: For 140m/m rotor
WEIGHT: 16g/pcs



ADP-RFA-P16

2027.P90-06

For flat mount frame adapter to post mount caliper.

MATERIAL: AL 6061-T6
Spec: For 160m/m rotor
WEIGHT: 23g/pcs



ADP-RFA-P18

2027.P90-07

For flat mount frame adapter to post mount caliper.

MATERIAL: AL 6061-T6
Spec: For 180m/m rotor
WEIGHT: 26g/pcs



NEW

ADP-EV-POD-L

2027.P87-04

Adapter for SRAM POD electronic controller mount on SHIMANO I-SPEC-EV system disc brake lever.

MATERIAL: AL6061-T6
SPEC: I-SPEC-EV (L SIDE)
WEIGHT: 12g

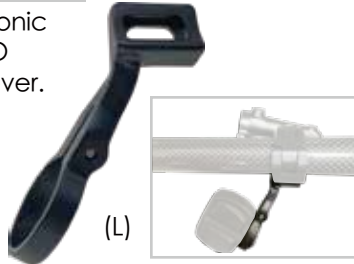

NEW

ADP-EV-POD-R

2027.P87-05

Adapter for SRAM POD electronic controller mount on SHIMANO I-SPEC-EV system disc brake lever.

MATERIAL: AL6061-T6
SPEC: I-SPEC-EV (R SIDE)
WEIGHT: 12g



ADP-EVMX22

2027.P87-06

Adapter for SRAM disc brake lever to SHIMANO shift lever with screw and nut.

MATERIAL: Forged AL 6061T6
SPEC: SRAM[®] MMX system to SHIMANO[®] I-SPEC-EV system
COLOR: Sand blast black



ADP-ISPEC-EV

2027.P87-07

SHIMANO[®] disc brake lever can fix SRAM[®] shift lever. With special screw and nut.

MATERIAL: AL6061 -T6
SPEC: I-SPEC-EV

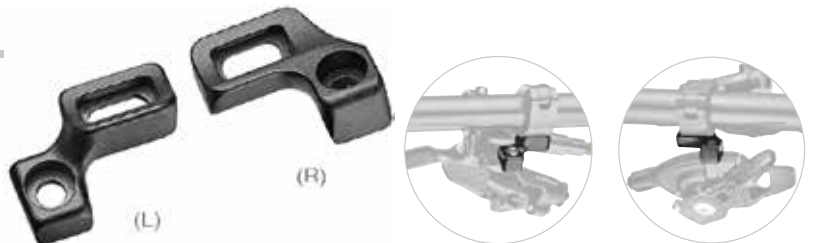

ADP-ISPEC-EV-21

2027.P87-08

SHIMANO[®] disc brake lever can fix SRAM[®] shift lever. With special screw and nut.

Left & right same angle.

MATERIAL: AL6061 -T6
SPEC: I-SPEC-EV
WEIGHT: 15g/ set



SDM-HANGER-001

2027.P99-01

Fit 2023 GIANT® TCR & PROPEL & DEFY.

MATERIAL: AL7075-T651

Custom available



ADP-BT-S

2027.P101-01

Holder for SRAM® AXS/ ETAP battery.

MATERIAL: Nylon66

COLOR: Black, red

With cable tie

Battery not included



CL-ISPEC-2

2027.P87-01

SHIMANO® SL-RS700 I-SPEC-2 flat bar shift lever to clamp type.

MATERIAL: AL6061-T6

SPEC: I-SPEC-2

COLOR: Sand blast black



EV-CLAMP-21

2027.P87-02

Shifter (shift lever) I-SPEC-EV mount.

MATERIAL: AL6061-T6

Compatibility handlebar: 22.2mm

Compatibility shift lever: SHIMANO®

WEIGHT: 25g



TL-105

2027.P98-04

Stainless steel plate nylon container.

CONTENT:

Spoke wrench x 1pcs / Patch x 12pcs
Tire seal strip x 5pcs / Self-adhesive patch x12pcs
Grinder x 1pcs



TL-105-E

2027.P98-05

CONTENT:

Stainless steel Bracket x 1pc / Nylon container x 1pc

F-STRAP

2027.P98-07

Quick and easy to carry repair kits when long distance riding.

VELCRO LENGTH : 58cm

Tools not included



F-STRAP-BAG

2027.P98-06

Quick and easy to carry repair kits when long distance riding, include mounting bag to helpful for sorting kit.

VELCRO LENGTH : 58cm

Tools not included





1. Choose a suitable fixing hole for the strap when the quick-release handle is in the open position.



2. Secure the straps completely into the mounting bracket.



3. Assembly is complete by closing the quick-release handle.

NEW
CL-CRZ

2027.P101-01

Seatpost-mounted connector designed for single-stay rear racks, featuring quick installation and secure attachment. Compatible with various shapes and different sizes seatposts.

MATERIAL: Nylon lever and bracket.
Rubber strape.

Patent pending.

ACCESSORIES

TL-500

2027.P95-01

End cap style storage for MTB alloy handle bar.

COMBO PLIER FEATURES:

Master link tool / Master link storage / Valve core tool / Tire lever / Bike chain hook / Storage vault

Patent in multiple countries

MATERIAL: Forged alloy and CNC machined

WEIGHT: 38.5g

TUBELESS REPAIR KIT CONTENT:

Reamer / Plugger / Tire seal strip

6 PCS BITS CONTENT:

Hex3 / 4 / 5 / 6 / PH1 / T25 with tool stick



P.A.T.E.D

Front

Back

Chain breaker

TL-750

2027.P97-01

Multi tool storage tube with CO2 cartridges thread.

compatible ADP-CO2-A1-T.

Include tube holder WB-UHD-22 for two pieces and end cap style storage TL-501 for MTB alloy handle bar.

COMBO PLIER FEATURES:

Master link tool / Master link storage / Valve core tool / Tire lever / Bike chain hook / Storage vault

Patent in multiple countries

MATERIAL: Forged alloy and CNC machined

WEIGHT: 38.5g

TUBELESS REPAIR KIT CONTENT:

Reamer / Plugger / Tire seal strip

6 PCS BITS CONTENT:

Hex3 / 4 / 5 / 6 / PH1 / T25 with tool stick

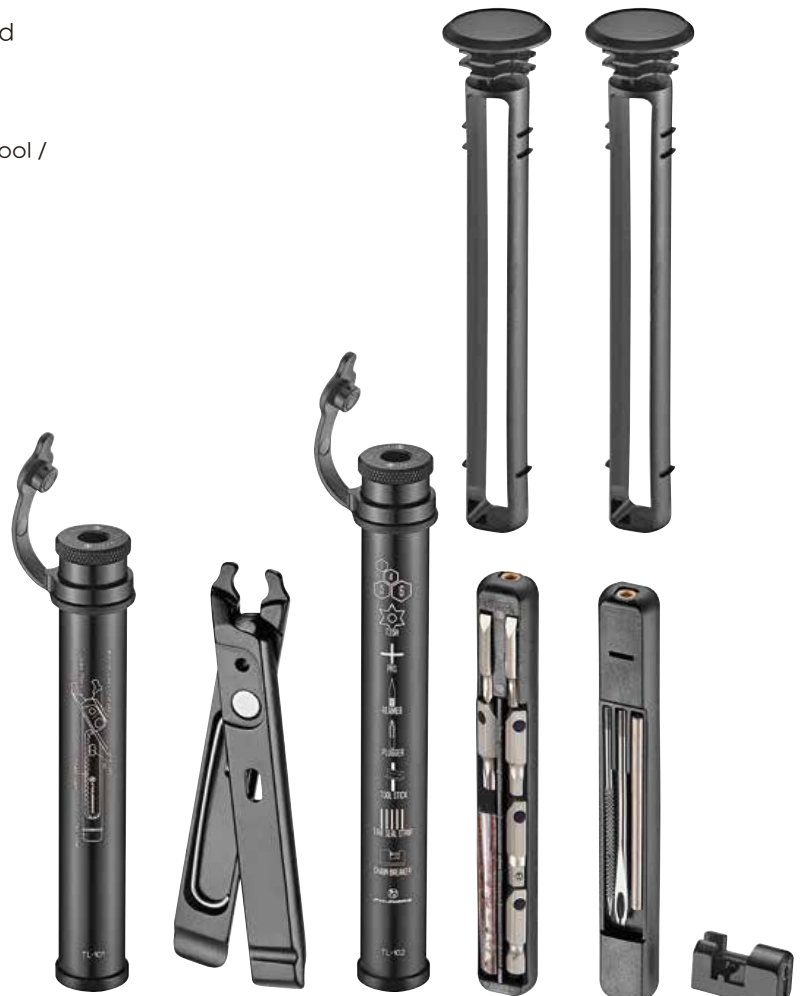

P.A.T.E.D

Front

Back

▶ TL-101-1 6 Functions features combo pliers content



▶ TL-102-1 8 Functions features tubeless repair kit

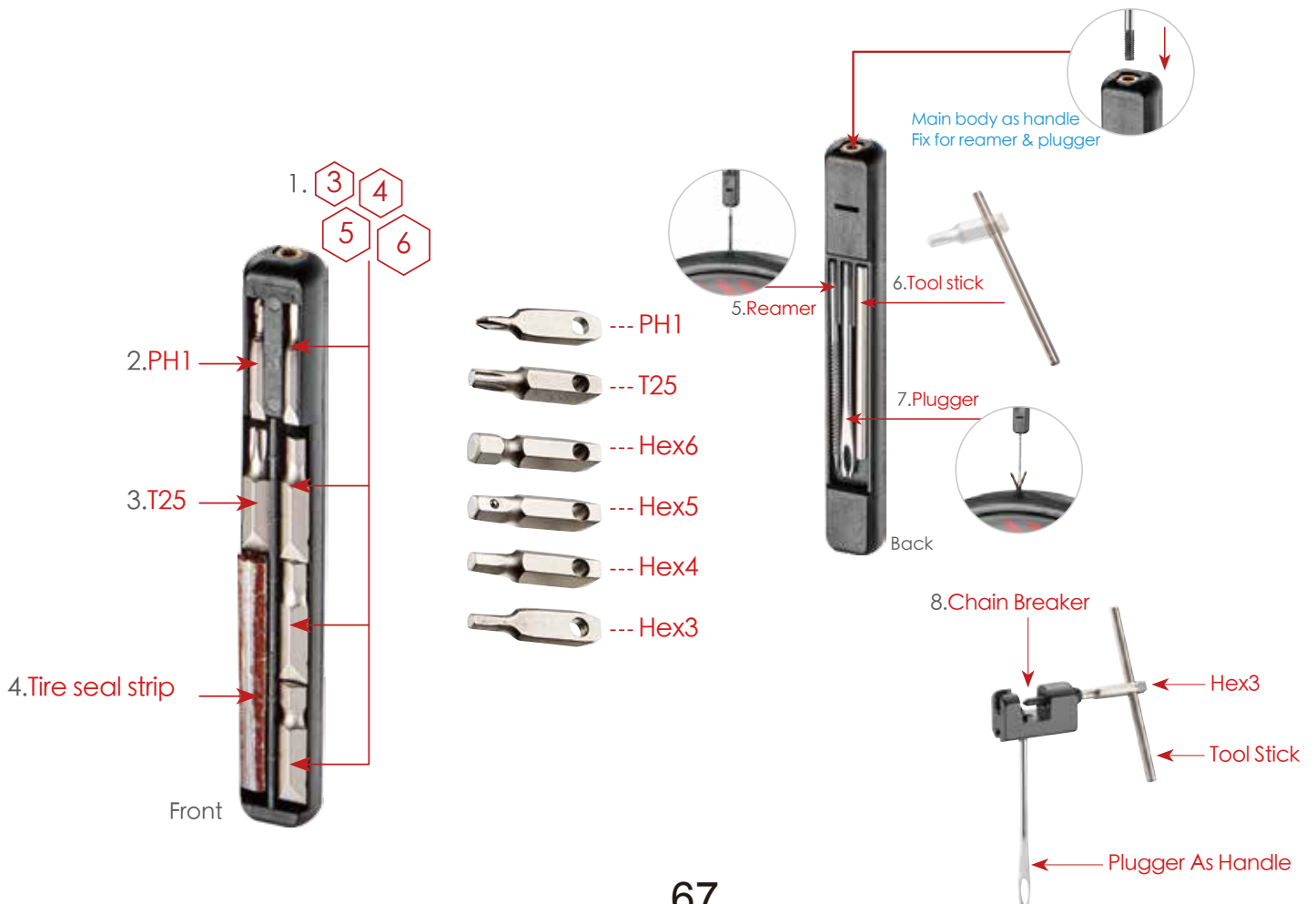

3
4
5
6

6功能扳手組 6 pcs bits

把手
Tool stick



十字
PH



梅花
T



六角
Hex



六角
Hex



六角
Hex



六角
Hex



鏈條配件 Links & Accessories

快扣
Chain quick links



可自行到商店購買
(You may purchase it in the shop)

快扣拆卸
Chain Pliers



快扣存放槽
Master Links Storage

鏈條鉤
Bike Chain Hook



打鏈器
Chain Breaker



補胎和配件 Patching Tire & Accessories

Co鋼瓶
Threaded
CO cartridges



可自行到商店購買
(You may purchase it in the shop)

Co氣瓶嘴
CO inflator
(選配)
(Option)



(短)打氣筒
(S)Bicycle Pump
(Option)



(長)打氣筒
(L)Bicycle Pump
(Option)

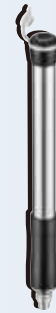

(長)打氣筒轉接頭
(L)Bicycle Pump Adapter
(Option)



FOURIERS 選配配件
(FOURIERS Option Accessories)

補胎和配件 Patching Tire & Accessories

補胎片
專用膠
Glue



磨片
Grinder



補胎片
Patch



自黏式
補胎片
Self-adhesive
patch



銼刀
Reamer

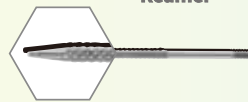

補胎條
Tire seal strip

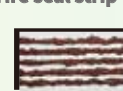

補胎條
壓入器
Plunger As Handle



輪框配件 Rim Set Accessories

輻條扳手
Spoke wrench



氣芯拆卸孔
Valve Core Tool



挖胎棒
Tire Lever
68



銅頭
Nipple



幅條
Spoke



可自行到商店購買
(You may purchase it in the shop)

Fitting Series



FITTING EQUIPMENT

ADP-FIT-WR

2027.P102-01

Quick and easy to change position for trainer or fitting.
Angle adjustment from 0 to 12 degrees.
Three wheels allow it to adjust itself.

HEIGHT RANGE: 80 - 290 mm

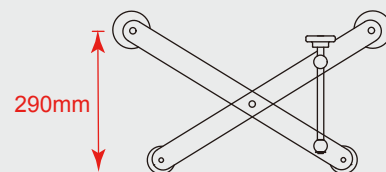
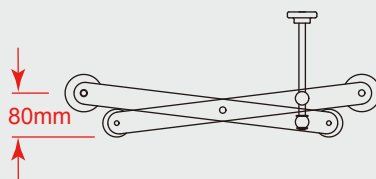

ADP-FIT-E220

2027.P103-02

Adjustable welding stem.

MATERIAL : AL6066

ANGLE : $\pm 8^\circ$

CLAMP HEIGHT : 50mm

C-C : 205mm

STEM TUBE SIZE : $\varnothing 28.6\text{m}$



Only for fitting setting not for outdoor riding.



ADP-FIT-RHB

2027.P103-01

Allow you to find the most appropriate handlebar width swiftly and painlessly.
Ease your physical fatigue for long distance riding.

MATERIAL : AL6061
SPEC : 320~440mm
DROP : ± 125 mm
REACH : ± 70 mm

Only for fitting setting not for outdoor riding.



Find your perfect handlebar width swiftly.



ADP-FIT-SA 2027.P103-03

Use the STEM ADJUSTER to provide fitting service for the biker on his or her own bike to earn the right stem length (50mm~150mm) and angle (± 30 degrees) .

FORK STACK HIGH : $\varnothing 40$ mm, $\varnothing 31.8$ mm with shim $\varnothing 28.6$ mm

HANDLEBAR CLAMP : $\varnothing 31.8$ mm

LENGTH : 50 - 150mm

ANGLE : $\pm 25^\circ$

OPTION : $\varnothing 35$ mm Clamp



FITTING EQUIPMENT

ADP-FIT-XYA

2027.P103-04

Stem slimension inspection platform.

MATERIAL: AL6061-T6

SPEC:

HANDLEBAR STEM: $\text{Ø}31.8 \times \text{Ø}34.9 \times (\text{H})50\text{mm} \times 1\text{pcs}$

SPACER: ID $\text{Ø}28.6 \times \text{ODØ}34.2 \times (\text{H})3\text{mm} \times 2\text{pcs}$

ID $\text{Ø}28.6 \times \text{ODØ}34.2 \times (\text{H})5\text{mm} \times 2\text{pcs}$

ID $\text{Ø}28.6 \times \text{ODØ}34.2 \times (\text{H})10\text{mm} \times 1\text{pcs}$

ID $\text{Ø}31.8 \times \text{ODØ}38.8 \times (\text{H})2.5\text{mm} \times 2\text{pcs}$

ID $\text{Ø}31.8 \times \text{ODØ}38.8 \times (\text{H})5\text{mm} \times 2\text{pcs}$

ID $\text{Ø}31.8 \times \text{ODØ}38.8 \times (\text{H})10\text{mm} \times 1\text{pcs}$

SHIM-CC-AL: ID $\text{Ø}28.6 \times \text{ODØ}31.8 \times (\text{H})38\text{mm} \times 1\text{pcs}$

ID $\text{Ø}31.8 \times \text{ODØ}34.9 \times (\text{H})58\text{mm} \times 1\text{pcs}$

WEIGHT: 2.515kg/set



ADP-FIT-CZ

2027.P103-05



Precision CNC machines fitting bike sizing cranks.

CRANK LENGTH: 145, 150, 155, 160, 165, 167.5, 170,
172.5, 175, 177.5, 180mm

AXLE: 24mm / 30mm

MATERIAL: CRANK: AL6061-T6

AXLE: AL 2024

CHAINRING: Single 46T

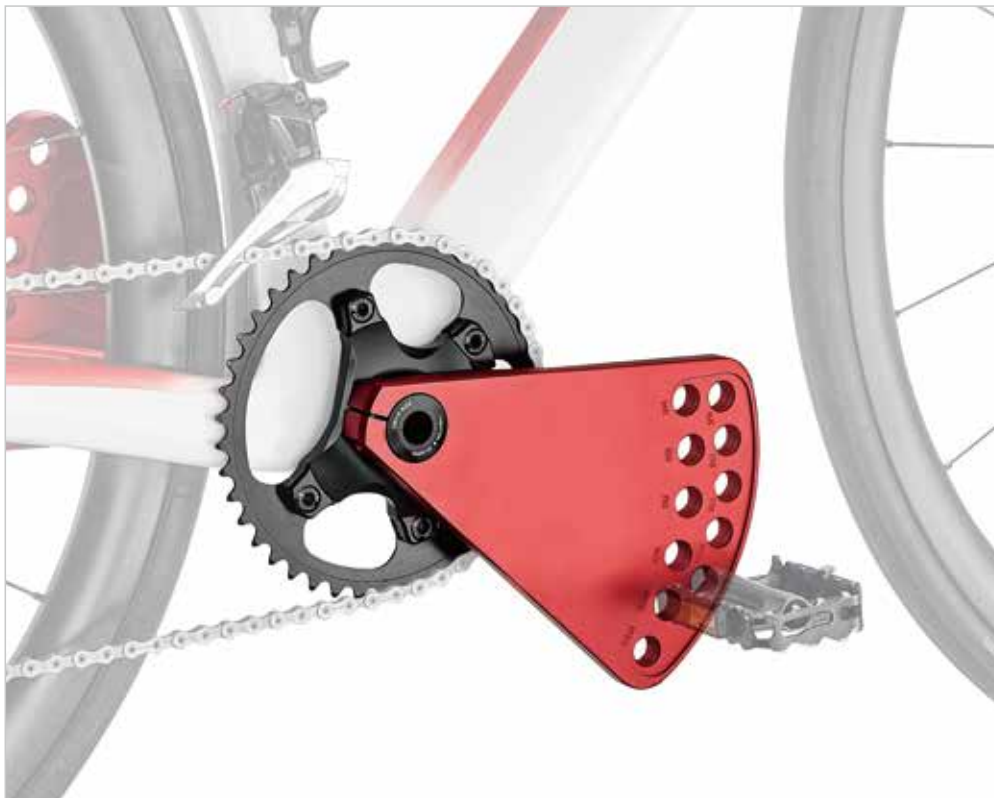

CK-GRA

2027.P33-01

SRM Spider PowerMeter with rechargeable system.

MATERIAL: SPINDLE: AL 2024

CHAINRING: AL7075-T651

CRANK: AL6066-T6 / Carbon fiber

CRANK LENGTH: AL6066-T6: 145, 147.5, 150, 152.5, 155,
157.5, 160, 162.5, 165, 167.5,
170, 172.5, 175mm

Carbon fiber: 145, 150, 155, 160, 165,
167.5, 170, 172.5, 175mm

GEAR COMBINATION: 34/50T, 36/52T, 39/53T, 42/54T, 42/55T

COLOR: S.B Black

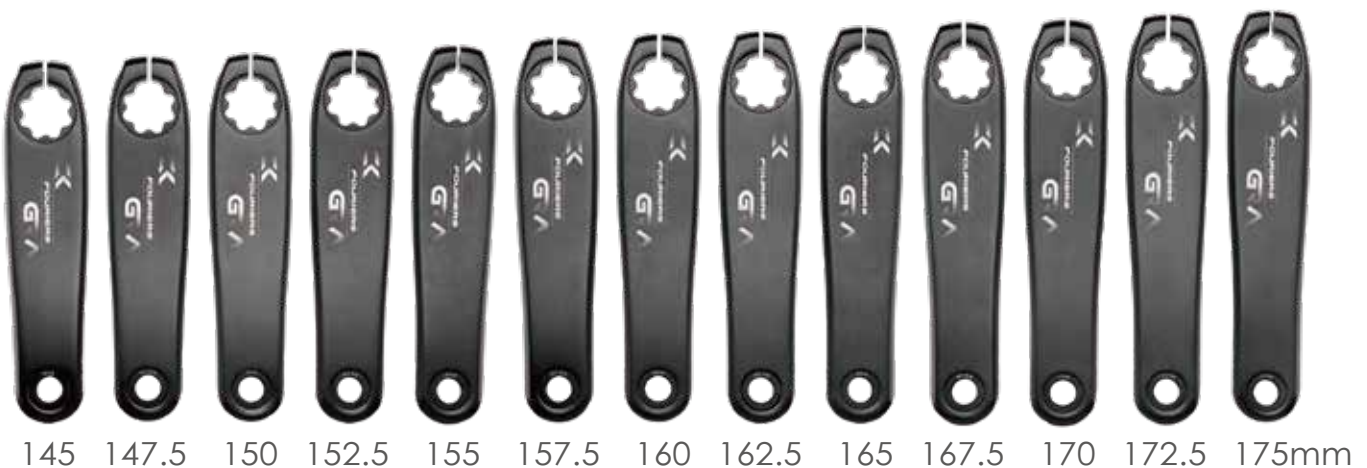

CRANK SET

